

Azura

▶ Pump P 6.1L

User Manual

V6890



HPLC

Table of Contents

Note For your own safety, **read** the manual and **always** observe the warnings and safety information on the device and in the manual!

Intended Use	6
Device Variants	6
Front View	6
Rear View	7
Side View	8
Features	8
Solvents	9
Scope of Delivery	11
Safety for Users	11
Definition of Personal and Material Damage	13
Decontamination	13
Symbols and Signs	14
Installation	15
Transport	15
Operating Environment	16
Setup	16
Unpacking	17
Capillary and Fittings	17
Connecting the Solvent Bottles	17
Pre-Installed Capillary	18
Integrating the Pump into an HPLC Flow System	18
Isocratic Pump	19
Connecting the Pump Head to the Solvent	19
Binary Pump	20
Connecting the Pump Head to the Solvent	21
Connecting the Solvent Selection Valve to the Solvent	21
Quaternary Pump	22
Connecting the Degasser	22
Connecting the Pump Head to the Solvent	23
Connecting the 4-Channel Degasser to the Solvent	23
Connecting the Valve Block	24
Connecting the Piston Backflushing	24
Connecting the Leak Management	25

Control	26
Connecting the Device to a Computer	27
Configuring the LAN Settings	27
Connecting the Cables	28
Configuring the Router	29
Integrating the LAN into a Company Network	29
Controlling Several Systems Separately in a LAN	29
Pin Header Connectors	30
Remote Connector	30
Explanations for Remote Connector	30
Events Connector	31
Explanations for Events Connector	32
Wiring the Terminal Strip	33
Analog Control	34
Power Supply	34
Operation	35
Initial Start-Up	35
Pump Head	35
De-Aerating the Pump	35
Switch-On	36
Control	37
Control with Chromatography Software	37
Control with Control Unit	37
Control with Mobile Control	37
Meaning of the LEDs	37
Functionality Tests IQ and OQ	38
Troubleshooting	39
LAN	39
Possible Problems and Troubleshooting	40
System Messages	41
Maintenance and Care	46
Contact with the Technical Support	46
Maintenance Contract	46
Maintenance Intervals	47
Cleaning and Caring for the Device	47
Checking the Fittings	47
Flushing the Pump	48
Putting the Pump Out of Operation	48
Storage	49
Disconnecting from Power Supply	49
Preparing the Pump Head for Storage	49
Dismounting the Pump Head	50

Check Valves 51
 Removing the Check Valve 51
 Cleaning the Check Valves 52
 Installing the Check Valve 52
 Replacing the Inline Filter 53
 Removing the Inline Filter 53
 Inserting the new Inline Filter Cartridge. 54
 Replacing the Mixer 55
 Removing a Leak 56
Technical Data 56
 P 6.1L Isocratic 56
 P 6.1L Binary 56
 P 6.1L Quaternary 57
 Flow Rate and Maximum Pressure 58
 P 6.1L General 58
Repeat Orders 60
 Modules 60
 Accessories and Spare Parts 60
Disposal 72
Legal Information 73
 Warranty Conditions 73
 Transport Damage 73
HPLC Glossary 74
Index 76

To whom it may concern In case you prefer a French language user manual for this product, submit your request including the corresponding serial number via email or fax to KNAUER:

- support@knauer.net
- +49 30 8015010

Thank you.

A qui que ce soit Si jamais vous préférez un manuel en français pour ce produit contacter KNAUER par email ou par fax avec le no. de série:

- support@knauer.net
- +49 30 8015010

Merci beaucoup.

Intended Use

Note Only use the device for applications that fall within the range of the intended use. Otherwise, the protective and safety equipment of the device could fail.

Description The pump P 6.1L is suitable for analytical and semi-preparative applications.

Scope of application The device can be used in the following areas:

- Biochemistry analysis
- Chemical analysis
- Food analysis
- Pharmaceutical analysis
- Environmental analysis

Device Variants

The P 6.1L is available in three different options:

- Isocratic pump
- Binary pump (HPG pump)
- Quaternary pump (LPG pump)

All variants are available as a standard version made of stainless steel or as a bio-inert version made of ceramics with PEEK capillary, PEEK connectors, and PEEK venting screw.

Front View

Isocratic pump The isocratic pump is equipped with a pressure sensor with an integrated inline filter and a venting screw.

Legend

- ① Pressure sensor
- ② Pump head

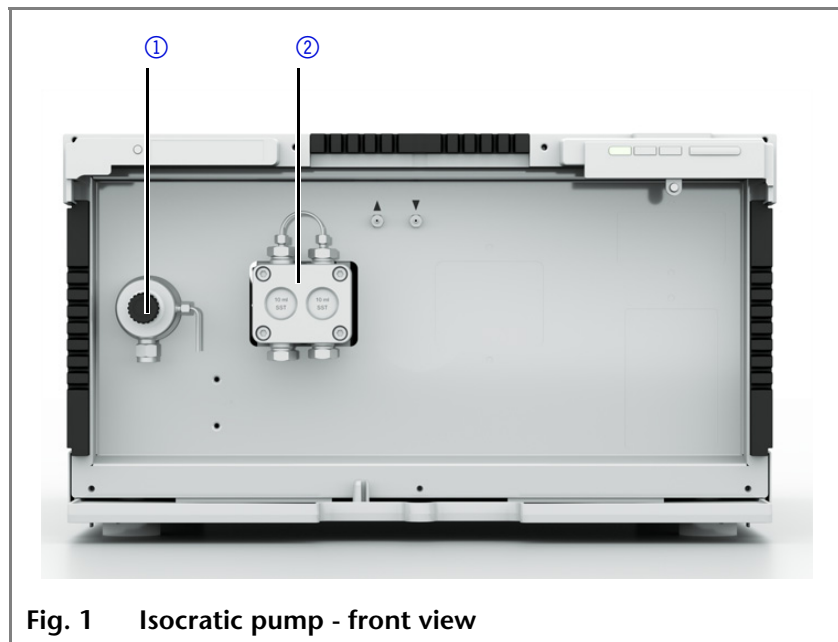

Binary pump The binary pump consists of two pump drives and a 2-channel degasser with a *Solvent Selection* valve. A pressure sensor with an integrated inline filter and a venting screw are also part of the pump.

Legend

- ① Pressure sensor
- ② Mixer
- ③ Pump head
- ④ Degasser
- ⑤ *Solvent Selection* valve

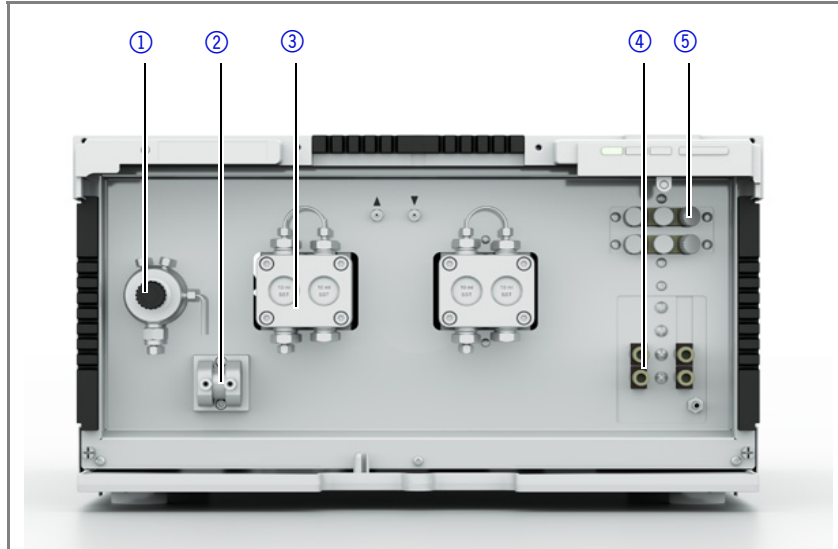

Fig. 2 Binary pump - front view

Quaternary pump The quaternary pump consists of a pump, a valve block and a 4-channel degasser. A pressure sensor with an integrated inline filter, a venting screw, and a mixer are also part of the pump.

Legend

- ① Pressure sensor
- ② Mixer
- ③ Pump head
- ④ Valve block
- ⑤ Degasser

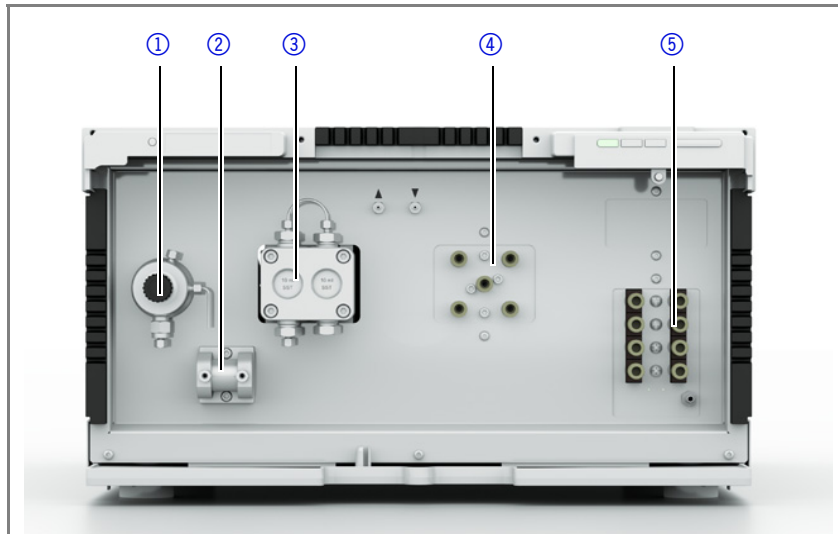

Fig. 3 Quaternary pump - front view

Rear View

On the back of pump, the connectors for LAN and power chord are located as well as the serial number of the device and the power switch (on/off).

Service interface Please note that the service interface is solely used for repair and maintenance tasks performed by service technicians.

Legend

- ① Serial number
- ② Interface for the Technical Support
- ③ Pin header
- ④ LAN port
- ⑤ Power connection and power switch

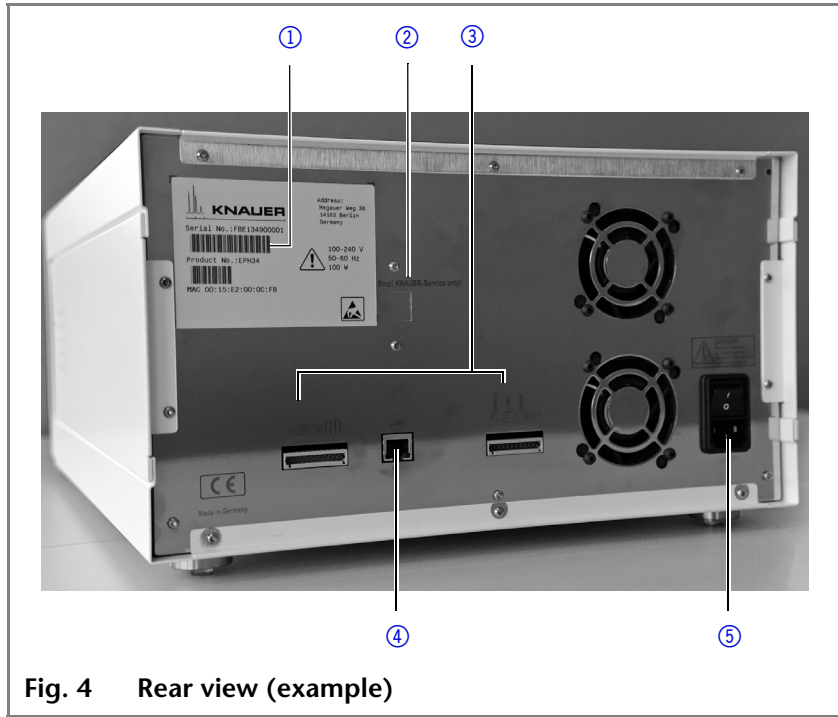

Fig. 4 Rear view (example)

Side View

On the side of the pump, the Control Unit (see "Control with Control Unit" on page 37) connector is located.

Legend

- ① Control Unit port



Fig. 5 Side View

Features

The pump is used to convey liquids, either in an HPLC system or as a stand-alone device. Liquids are conveyed either with constant flow or with constant pressure. The flow and pressure, which liquids can be conveyed with, depend on the pump head.

Pump Heads Pump heads for several areas of application are available for the pump P 6.1L.

	Standard	Bio-inert
Size	5 ml, 10 ml and 50 ml	10 ml and 50 ml
Material	Pump head with stainless steel inlays	Pump head with ceramic inlays

	Standard	Bio-inert
Scope of Application	<ul style="list-style-type: none"> HPLC Dosing applications with non-aggressive media 	<ul style="list-style-type: none"> Purification/FPLC Ion chromatography

Every pump head is equipped with an RFID chip. It is used to monitor and save all important parameters and settings. RFID technology offers the following advantages:

- Software automatically recognizes the parameters of the pump head
- All service-relevant data of the pump head is stored

Mixer Volume of the mixer is 100 µl. The mixer is exchangeable and can be replaced by mixers with a volume of 50 µl or 200 µl .

The parameters necessary for the mixer are set via Control Unit or via chromatography software.

	Stainless steel	Bio-inert
Size	50 µl, 100 µl, 200 µl	250 µl
Pressure	1000 bar	400 bar

Piston backflushing The piston backflushing function automatically flushes the rear piston area of the pump head upon switch-on and in continuous mode.

- Upon switch-on: The rear piston area of the pump head is automatically flushed for 15 seconds.
- In continuous mode: The rear piston area of the pump head is flushed automatically every 15 minutes, for 15 seconds.

PMax Mode This mode protects the column from excessive fluctuations in pressure. If the maximum pressure is reached, the user can decide if the pump should be switched off or continue running with constant pressure. You find a detailed description on how to use this option in the respective software manual.

GLP data The Control Unit, the Mobile Control and the different software products (e.g. ClarityChrom® or OpenLAB®) can be used to display or read out the GLP data of the pump. You find a detailed description on how to display or read out GLP data in the respective user manuals.

Optional accessories The following optional accessories are available:

- Pump head cooler for the pump head
- Control Unit
- Mobile Control

Solvents

Even small quantities of other substances, such as additives, modifiers, or salts can influence the durability of the materials. If there is any doubt, contact the Technical Support of the manufacturer.

Suitable solvents

- Acetate buffer solutions
- Acetone at 4 °C–25 °C (39.2 °F–77.0 °F)¹
- Acetonitrile²
- Benzene
- Carbon dioxide (liquid 99.999 % CO₂)
- Chloroform
- Dilute acetic acid (e.g. 0.1–1 %) at 25 °C/77.0 °F
- Dilute ammonia solution
- Dilute sodium hydroxide (1 M)
- Ethyl acetate
- Ethanol
- Formate buffer solution
- Isopropanol
- Methanol
- Phosphate buffer solutions (0.5 M)
- Toluol
- Water

1. valid for the specified temperature range
2. not recommended in combination with PEEK small parts and PEEK capillary

Less suitable solvents

- Diethylamine (0.1 %) (DEA)
- Dilute phosphoric acid
- Dimethyl sulfoxide (DMSO)
- Methylene chloride¹
- Slightly volatile solvents
- Tetrahydrofuran (THF) ¹
- Triethylamine (0.1 %) (TEA)
- Trifluoroacetic acid (0.1 %) (TFA)

1. not recommended in combination with PEEK small parts and PEEK capillary

Not suitable solvents

- Concentrated mineral and organic acids
- Concentrated bases
- Halogenated hydrocarbons, e.g. Freon[®]
- Perfluorinated solvents, e.g. Fluorinert[®] FC-75, FC-40
- Perfluorinated polyether, e.g. Fomblin[®]
- Solvents containing particles

Solvents not suitable for degassers
<ul style="list-style-type: none"> ▪ Azides ▪ Benzene ▪ Carbon dioxide (liquid 99.999 % CO₂) ▪ Concentrated mineral and organic acids ▪ Concentrated bases ▪ Dilute sodium hydroxide (1 M) ▪ Halogenated hydrocarbons, e.g. Freon[®] ▪ Hexafluoroisopropanol ▪ Hexanes (60 % <i>n</i>-Hexane) ▪ Hydro fluoro solvents ▪ Perfluorinated solvents, e.g. Fluorinert[®] FC-75, FC-40 ▪ Perfluorinated polyether, e.g. Fomblin[®] ▪ Solvents containing particles

- Flushing solution** These are the recommended flushing solutions, e.g. for the piston backflushing:
- Water
 - Mixture of 80 % water and 20 % ethanol
 - Isopropanol

Scope of Delivery

Note Only use spare parts and accessories made by KNAUER or a company authorized by KNAUER.

Delivery	Pump P 6.1L
	Power cable
	AZURA accessories kit, P 6.1L accessories kit
	User manual English/German
	Installation Qualification

Safety for Users

Professional Group The user manual addresses persons who are qualified as chemical laboratory technicians or have completed comparable vocational training.

The following knowledge is required:

- Fundamental knowledge of liquid chromatography
- Knowledge regarding substances that are suitable only to a limited extent for use in liquid chromatography
- Knowledge regarding the health risks of chemicals
- Participation during an installation of a device or a training by the company KNAUER or an authorized company.

If you do not belong to this or a comparable professional group, you may not perform the work described in this user manual under any circumstances. In this case, please contact your superior.

Safety Equipment

When working with the device, take measures according to lab regulations and wear protective clothing:

- Safety glasses with side protection
- Protective gloves
- Lab coat

What must be taken into account?

- All safety instructions in the user manual
- The environmental, installation, and connection specifications in the user manual
- National and international regulations pertaining to laboratory work
- Original spare parts, tools, and solvents made or recommended by KNAUER
- Good Laboratory Practice (GLP)
- Accident prevention regulations published by the accident insurance companies for laboratory work
- Filtration of substances under analysis
- Use of inline filters
- Once they have been used, never re-use capillaries in other areas of the HPLC system.
- Only use a given PEEK fitting for one specific port and never re-use it for other ports. Always install new PEEK fittings on each separate port.
- Follow KNAUER or manufacturer's instructions on caring for the columns

More safety-relevant information is listed in alphabetical order in the following table:

Topic	Explanations
flammability	Organic solvents are highly flammable. Since capillaries can detach from their screw fittings and allow solvent to escape, it is prohibited to have any open flames near the analytical system.
solvent tray	Risk of electrical shock or short circuit if liquids get into the device's interior. For this reason, place all bottles in a solvent tray.
solvent lines	Install capillaries and tubing in such a way that liquids cannot get into the interior in case of a leak.
leaks	Regularly check if any system components are leaking.

Topic	Explanations
power cable	Defective power cables are not to be used to connect the device and the power supply system.
self-ignition point	Only use eluents that have a self-ignition point higher than 150 °C under normal ambient conditions.
power strip	If several devices are connected to one power strip, always consider the maximum power consumption of each device.
power supply	Only connect devices to voltage sources, whose voltage equals the device's voltage.
toxicity	Organic eluents are toxic above a certain concentration. Ensure that work areas are always well-ventilated! Wear protective gloves and safety glasses when working on the device!

Where is use of the device prohibited? Never use the system in potentially explosive atmospheres without appropriate protective equipment. For further information, contact the Technical Support of KNAUER.

Decommissioning the Device Securely At any time, take the device completely out of operation by either switching off the power switch or by pulling the power plug.

Opening the Device The device may be opened by the KNAUER Technical Support or any company authorized by KNAUER only.

Definition of Personal and Material Damage

Possible dangers related to the device are divided into personal and material damage in this user manual.

Category	Explanations
DANGER!	Lethal or very serious injuries can occur.
WARNING!	Serious or moderate injuries can occur.
CAUTION!	Moderate injuries can occur. Device defects can occur.

Decontamination

Contamination of devices with toxic, infectious or radioactive substances poses a hazard for all persons during operation, repair, sale, and disposal of a device.



DANGER!
Health danger if getting in contact with toxic, infectious or radio-active substances.
Before disposing of the device or sending it away for repair, you are required to decontaminate the device adequately.

All contaminated devices must be properly decontaminated by a specialist company or the operating company before they can be recommissioned, repaired, sold, or disposed of. All materials or fluids used for decontamination must be collected separately and disposed of properly.

Symbols and Signs

The following symbols and signs can be found on the device, in the chromatography software or in the user manual:

	Symbol	Meaning
Warning signs		High-voltage hazard
		Electric shock hazard
		Danger caused by potentially toxic substances
		Electrostatic discharge hazard, damages to system, device, or components can occur.
		General warning sign, moderate injuries can occur and also damages to system, device, or components.
		Leak hazard, damage to device can occur.
		Note maximum weight-loading of the leak tray during transport, installation and operation.
CE mark		A device or system marked with CE fulfills the product specific requirements of European directives. This is confirmed in a Declaration of Conformity.

Symbol	Meaning
	Testing seals in Canada and the USA at nationally recognized testing centers (NRTL). The certified device or system has successfully passed the quality and security tests.

Installation

The chapter Installation describes all preparatory steps prior to the start-up. If you encounter difficulties during installation, contact the Technical Support.

Contact data

Phone	+49 30 809727-111
Fax	+49 30 8015010
E-mail	support@knauer.net

Transport

Carefully prepare the device for transport or storage. If you want to return your device to KNAUER for repairs, enclose the Service Request Form which can be downloaded from our website.

Device data

For a secure transport, note the weight and dimensions of the pump (see Technical Data).



CAUTION!

Damage to the device by lifting on protruding housing parts.

Lift the device on the side of the housing only.

Lifiting

Clasp the device at its side panels and lift it out of the packaging. Do not hold onto front cover or leak tray.

Operating Environment

Ambient conditions Only if the requirements for ambient conditions are met, can the intended use be ensured.

- Sunlight: Protect the device against direct exposure to sunlight.
- AC system: Set up the device at a location not exposed to air drafts.
- Vibration: Do not set up the device in the vicinity of other machines that cause floor vibrations.
- Installation site:
 - Position the device on a level and even surface.
 - Height above sea level: maximum 2000 m
- Weight

11.5 kg isocratic
14.1 kg binary
12.7 kg quaternary
- Dimensions

361 mm x 208.2 mm x 523 mm

 (width × height × depth)
- Power supply

Input 100–240 V
Output 50–60 Hz
- Maximum power consumption

100 Watt

- Humidity

< 90 %, non-condensing

- Temperature

10–40 °C (50–104 °F)

Earth quake regions If the device is set up in a region where earth quakes are common, secure the device at the two fixing points ①. The fixing points are situated on both sides of the device.

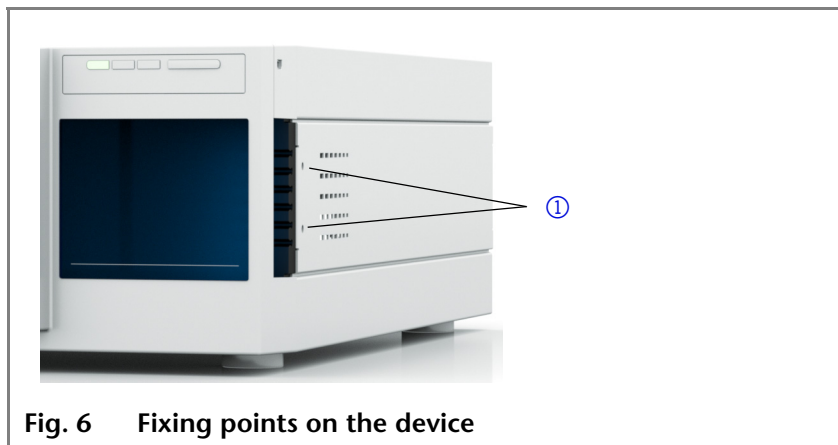

Fig. 6 Fixing points on the device

Setup

Prior to setting up the device, find a suitable place according to the requirements and remove the packaging. The requirements and a description can be found in the following section.

Unpacking

Prerequisite Check packaging for damage caused during transportation.

Tool Utility knife



CAUTION!

Damage to the device by lifting on protruding housing parts.

Lift the device on the side of the housing only.

Procedure

Process
1. Set-up the package in such a way that you can read the label. Using the utility knife, cut the adhesive tape and open the packaging. 2. Remove the foam insert. Take out the accessories kit and the manual.
3. Open the accessories kit and check the scope of delivery. In case any parts are missing, contact the Technical Support. 4. Clasp the device from below, lift it out of the packaging and place it on its feet. Do not hold onto the front cover.
5. Check the device for signs of damage that occurred during transport. In case you notice any damage, contact the Technical Support. 6. Place the device in its site of operation and remove protective foil.

Next steps Store packaging and keep the included packing list for repeat orders.

Capillary and Fittings

All tubing and capillary, which connect the components of the pump, are pre-installed. Only the solvent bottles have to be connected and the pump has to be integrated into the flow of the HPLC system.

Connecting the Solvent Bottles

To connect the solvent bottles, tubing with pre-installed solvent filters is used. The tubing is connected to the device with flangeless fittings.

Note Do not use tools so as to not damage the fittings.

Procedure	Process	Figure
	<ol style="list-style-type: none"> Slide the flangeless fitting ① over the tubing. Slide the lock ring ② over the tubing, cap with the sealing ring ③. Note the direction of the lock ring, otherwise the sealing ring could be damaged. The thicker end of the lock ring must point into the direction of the fitting. Fasten the polymer seal. 	<p>Fig. 7 Set-up of a flangeless fitting</p>
	<ol style="list-style-type: none"> Manually fasten the flangeless fitting ④ to the device. 	<p>Fig. 8 Fully assembled flangeless fitting</p>

Pre-Installed Capillary

Pre-installed stainless steel and PEEK capillary is color-coded according to its inner diameter.

Color	Material	Inner diameter
red marker	Stainless steel	0.1 mm
blue marker	Stainless steel	0.25 mm
black marker	Stainless steel	0.45 mm
blue stripes	PEEK	0.25 mm
orange stripes	PEEK	0.5 mm

Note PEEK capillary is not suitable for use with Acetonitrile. Acetonitrile can cause capillary to crack or rupture.

Integrating the Pump into an HPLC Flow System

The pump can be integrated into an HPLC flow system by connecting the pressure sensor (isocratic version) or the mixer (binary or quaternary version) and the HPLC system with capillary.

Note To integrate the pump into a system, note the ambient conditions found in the sections Operating Environment and Technical Data as well as the ambient conditions of other devices to be integrated into that system.



CAUTION!
Damage to the pump head caused by overtightened capillary fittings!
Note the torque of the fittings:
 - 5 Nm for stainless-steel fittings
 - 0.5 Nm for PEEK fittings

Tool Torque wrench

Procedure Stainless steel fittings are tightened with 5 Nm, PEEK fittings are tightened with 0.5 Nm.

Isocratic Pump

The figure shows the installation plan for capillary and tubing on the isocratic version of the pump. If you own a different version of the pump, see the corresponding chapter for installation instructions.

The gray lines represent the connection of the solvents to the pump and the black lines represent the connection of the piston backflushing.

Capillary layout

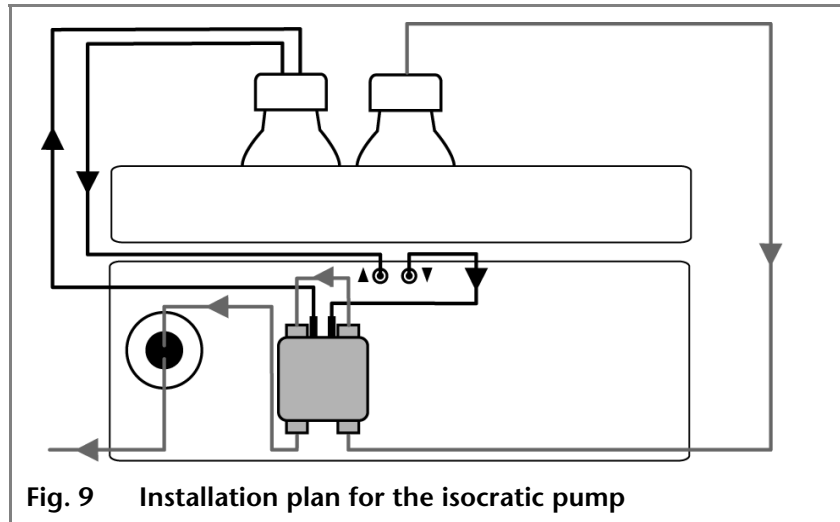

Fig. 9 Installation plan for the isocratic pump

Piston backflushing The flushing solution is re-used. Since the flow path is circular, only one bottle is used for the flushing solution.

Solvent flow path The pump head takes the liquid in from the bottle and conveys it to the pressure sensor.

Connecting the Pump Head to the Solvent

- Prerequisites**
- The device has been switched off.
 - The power plug has been pulled.
 - The front cover has been removed.

Material Flangeless fitting



CAUTION!
Damage to the pump head possible!
Remove the cap fittings from the inlet and outlet of the pump head prior to use!

Procedure	Process	Figure
	<ol style="list-style-type: none"> Slide the flangeless fitting onto the tubing. Insert the tubing into the free inlet ① on the bottom of the pump head. Tighten the fitting by hand. 	 <p data-bbox="954 846 1385 909">Fig. 10 Solvent line on the pump head</p>

Next steps Integrate the pump into the HPLC flow system.

Binary Pump

The figure shows the installation plan for capillary and tubing on the binary version of the pump. If you own a different version of the pump, see the corresponding chapter for installation instructions.

The gray lines represent the connection of the solvents to the pump and the black lines represent the connection of the piston backflushing.

Capillary layout

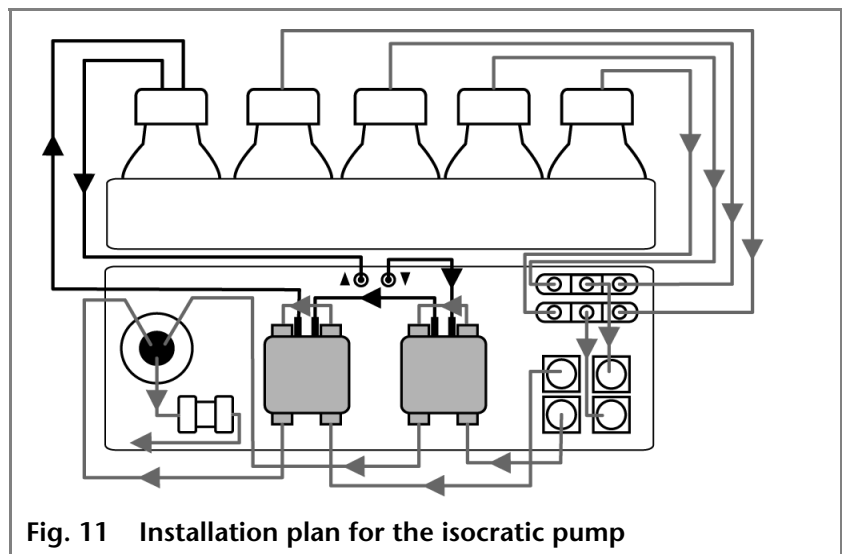

Piston backflushing The flushing solution is re-used. Since the flow path is circular, only one bottle is used for the flushing solution.

Solvent flow path Every pump head can operate with two different solvents. Both solvents are connected with the *Solvent Selection* valve. The solvents are conveyed into one pump head each and combined in the pressure sensor. The pressure sensor is connected to the mixer. The mixer is connected to the HPLC system.

Connecting the Pump Head to the Solvent

- Prerequisites**
- The device has been switched off.
 - The power plug has been pulled.
 - The front cover has been removed.

Material Flangeless fitting



CAUTION!
Damage to the pump head possible!
 Remove the cap fittings from the inlet and outlet of the pump head prior to use!

Procedure

Process	Figure
<ol style="list-style-type: none"> 1. Slide the flangeless fitting onto the tubing. 2. Insert the tubing into the free inlet ① on the bottom of the pump head. 3. Tighten the fitting by hand. 	<p>Fig. 12 Solvent line on the pump head</p>

Next steps Integrate the pump into the HPLC flow system.

Connecting the Solvent Selection Valve to the Solvent

Note The Solvent Selection valve is readily connected to the 2-channel degasser.

The *Solvent Selection* valves allows selecting from two different solvents for each solvent channel, without having to re-install the tubing. For both solvent channels A and B, one of two solvents can be selected. Solvent A is connected to inlets A1 and A2, solvent B is connected to inlets B1 and B2.

- Prerequisite**
- The device has been switched off.
 - The power plug has been pulled.
 - The front cover has been removed.

Material Flangeless fitting

Procedure

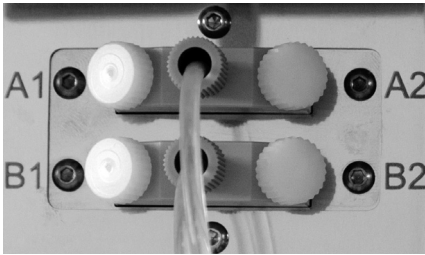
Process	Figure
<ol style="list-style-type: none"> 1. Connect the tubing from the four solvent bottles to the inlets A1, A2 and B1, B2. 2. Seal inlets not in use with cap fittings. 	 <p>Fig. 13 Solvent Selection valve with cap fitting</p>

Next steps Integrate the pump into the HPLC flow system.

Quaternary Pump

The figure shows the installation plan for capillary and tubing on the quaternary version of the pump. If you own a different version of the pump, see the corresponding chapter for installation instructions.

The gray lines represent the connection of the eluents to the pump and the black lines represent the connection of the piston backflushing.

Capillary tubing layout

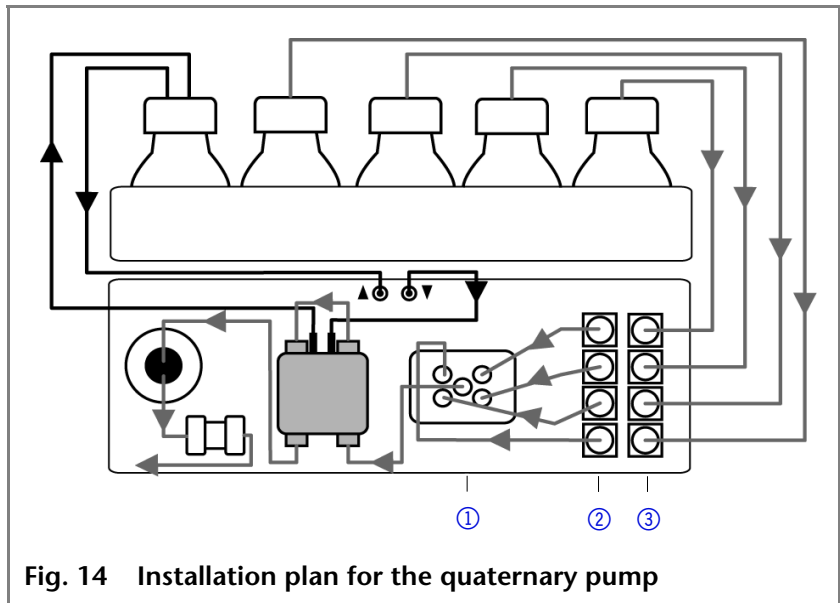

Piston backflushing The flushing solution is re-used. Since the flow path is circular, only one bottle is used for the flushing solution.

Connecting the Degasser

The degasser outlet is readily connected to the valve block.

Flow path solvent The four solvents are connected with the inlet of the degasser. The solvent mixture is conveyed from the degasser via the valve block into the pump head. From the pump head it is taken to the mixer. The mixer is connected to the HPLC system.

Connecting the Pump Head to the Solvent

- Prerequisites**
- The device has been switched off.
 - The power plug has been pulled.
 - The front cover has been removed.

Material Flangeless fitting



CAUTION!
Damage to the pump head possible!
Remove the cap fittings from the inlet and outlet of the pump head prior to use!

Procedure	Process	Figure
	<ol style="list-style-type: none"> 1. Slide the flangeless fitting onto the tubing. 2. Insert the tubing into the free inlet ① on the bottom of the pump head. 3. Tighten the fitting by hand. 	<p style="text-align: center;">Fig. 15 Solvent line on the pump head</p>

Next steps Integrate the pump into the HPLC flow system.

Connecting the 4-Channel Degasser to the Solvent

The 4-channel degasser contains four degassing chambers. Each degassing chamber has an inlet and an outlet on the front of the pump.

- Prerequisite**
- The device has been switched off.
 - The power plug has been pulled.
 - The front cover has been removed.

Material Flangeless fitting

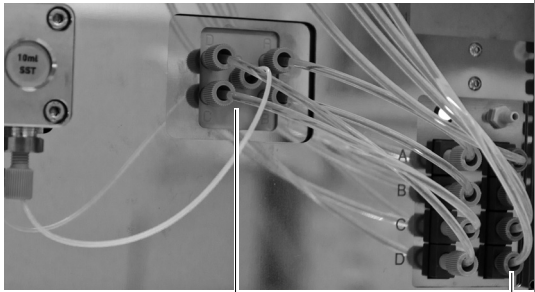

CAUTION!
Very high pressures damage the degasser membrane. The membrane can withstand a maximum pressure of 7 bar.
Do not connect the degasser to the pump outlet.

Procedure	Process	Figure
	<ol style="list-style-type: none"> 1. Connect the tubing from the four solvent bottles to the inlets A, B, C, and D of the degasser (see ②). 2. Seal inlets not in use with cap fittings. 	 <p data-bbox="871 613 1407 674">Fig. 16 4-channel degasser with valve block</p>

Next steps Integrate the pump into the HPLC flow system.

Connecting the Valve Block



Note Note the instructions on how to install the flangeless fitting in chapter (see “Capillary and Fittings” on page 17)

The valve block inlets ① are pre-installed. If the central outlet connection has to be changed, e.g. you want to install different capillary, note that at least two of the outer flangeless fittings on the valve block are loosened in order to be able to install connection in the center by hand.

Connecting the Piston Backflushing

The piston backflushing removes salts and other substances from the area behind the pump head seals. To do this, connect a bottle with flushing solution to the flush pump and the piston backflushing. The silicone tubing between the piston backflushing and the flush pump are pre-installed.

Designation Inlet and outlet of the flush pump are located on the front of the device. The flush pump is inside of the device and not visible from the outside.

	
<p>Fig. 17 Inlet symbol</p>	<p>Fig. 18 Outlet symbol</p>

Prerequisite

- The pump has been set-up at the site of operation.
- The pump has been switched off.

Material Silicone tube

Procedure

Process	Figure
<ol style="list-style-type: none"> 1. Plug one silicone tube onto the inlet ③ of the flush pump and connect to the flushing solution bottle. 2. Plug a second silicone tube onto a vacant capillary connector ① of the flush pump and connect to the flushing solution bottle. 	<p>Fig. 19 Silicone tube between piston backflushing and flush pump</p>

Connecting the Leak Management

The leak management consists of the leak sensor and the drainage system. The drainage system ensures that escaping liquids flow into a waste bottle. If there is too much liquid, the red LED starts flashing. Both the device and the data acquisition via chromatography software are stopped.

Prerequisite ▪ The front cover has been removed.

Procedure

Process	Figure
<ol style="list-style-type: none"> 1. Carefully push the funnel ① into the center opening of the capillary guide ②. 	<p>Abb. 20 Funnel and capillary guide</p>
<ol style="list-style-type: none"> 2. Push the long ending of the first nozzle ④ into the hose ③. 	<p>Abb. 21 Hose and nozzle</p>

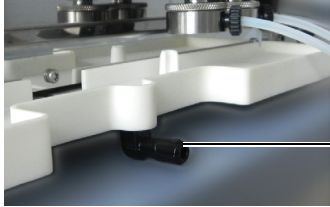
Procedure	Process	Figure
	<ol style="list-style-type: none"> 3. Connect the nozzle and the funnel. 4. Push the other end of the hose onto the nozzle ⑤ of the leak tray. 	 <p data-bbox="963 678 1321 741">Abb. 22 Hose connected to device</p>
	<ol style="list-style-type: none"> 5. For the bottom device, push the short end of the nozzle ⑥ into the opening in the collection point of the leak tray. 6. Connect the hose to the nozzle and lead the second ending to the waste bottle. 7. Place the waste bottle below the bottom device. 	 <p data-bbox="963 996 1350 1032">Abb. 23 Leak tray with nozzle</p>

Next steps Attach the front cover.

Control

The pump can be controlled externally in two ways:

- Via the pin head
- As part of a LAN, via the LAN connector of the router

All connectors for external control are located on the rear side of the pump.

The pump can also be controlled via the Control Unit. The Control Unit connector is located on the side of the device.

Legend

- ① Service interface
- ② Events connector
- ③ LAN connector
- ④ Remote connector

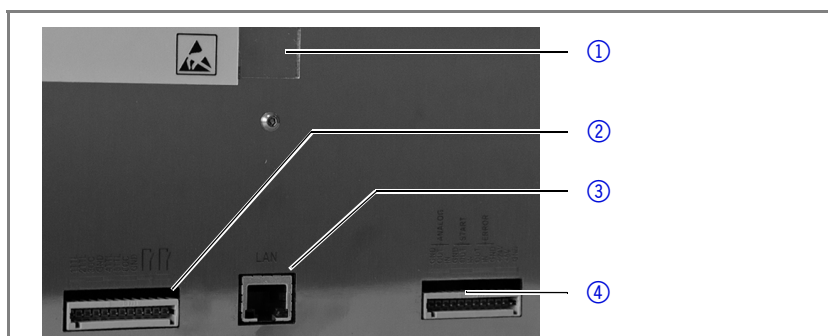
**Fig. 24** Connectors on rear side

- ⑤ Control Unit connector located on the side of the device.

**Fig. 25** Control Unit port

Connecting the Device to a Computer

This section describes how to set up an HPLC system in a local area network (LAN) and how a network administrator can integrate this LAN into your company network. The description applies to the operating system Windows® and all conventional routers.

Note To set up a LAN, we recommend to use a router. That means the following steps are required:

- Process**
1. On the computer, go to the control panel and check the LAN properties.
 2. Hook up the router to the devices and the computer.
 3. On the computer, configure the router to set up the network.
 4. Install the chromatography software from the data storage device.
 5. Switch on the device and run the chromatography software.

Configuring the LAN Settings

The LAN uses only one server (which is normally the router) from that the devices automatically receive their IP address.

- Prerequisite**
- In Windows®, power saving, hibernation, standby, and screen saver must be deactivated.
 - In case you use an USB-to-COM box, the option "Allow the computer to turn off this device to save power" in the device-manager must be deactivated for all USB hosts.
 - Only for Windows 7: For the network adapter, the option "Allow the computer to turn off this device to save power" in the Device Manager must be deactivated.

- Procedure**
1. In Windows 7 choose *Start* ⇒ *Control Panel* ⇒ *Network and Sharing Center*.

2. Double-click on *LAN Connection*.
3. Click on the button *Properties*.
4. Select *Internet Protocol version 4 (TCP/IPv4)*.
5. Click on the button *Properties*.
6. Check the settings in the tab *General*. The correct settings for the DHCP client are:
 - a) *Obtain IP address automatically*
 - b) *Obtain DNS server address automatically*
7. Click on the button *OK*.

Connecting the Cables

A router has several LAN ports and one WAN port that can be used to integrate the LAN into a wide area network (WAN), e.g. a company network or the Internet. In contrast, the LAN ports serve to set up a network from devices and a computer. To avoid interference, we recommend operating the HPLC system separately from the company network.

You will find patch cables for each device and the router in the accessories kit. To connect the router to a WAN, an additional patch cable is required, which is not supplied within the scope of delivery.

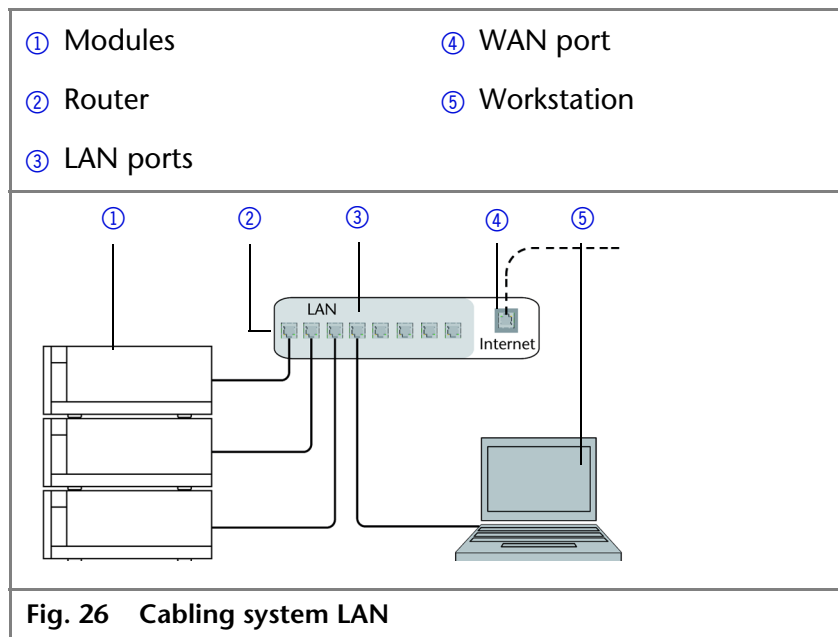

- Prerequisite**
- The computer has been switched off.
 - There is a patch cable for each device and the computer.

- Procedure**
1. Use the patch cable to connect the router and the computer. Repeat this step to connect all devices.
 2. Use the power supply to connect the router to the mains power system.

Configuring the Router

The router is preset at the factory. You will find a label at the bottom side of the router, on which IP address, user name, and password are printed. These information help to open the router configuration.

- Procedure**
1. To open the router configuration, start your Internet browser and enter the IP address (not for all routers).
 2. Enter user name and password.
 3. Configure the router as DHCP server.
 4. In the router configuration, check the IP address range and make changes if necessary.

Result Once the router has assigned IP addresses to all devices, the chromatography software can be used to remotely control the system.

Integrating the LAN into a Company Network

A network administrator can integrate the LAN into your company network. In this case you use the WAN port of the router.

Prerequisite There is a patch cable for the connection.

- Procedure**
1. Check that the IP address range of the router and of the company network do not overlap.
 2. In case of an overlap, change the IP address range of the router.
 3. Use the patch cable to connect the router WAN port to the company network.
 4. Restart all devices, including the computer.

Controlling Several Systems Separately in a LAN

Devices connected to a LAN communicate through ports, which are part of the IP address. If more than one HPLC system is connected to the same LAN and you plan on controlling them separately, you can use different ports to avoid interference.

Therefore, the port number for each device must be changed and this same number must be entered into the device configuration of the chromatography software. We recommend to use the same port number for all devices in the same system.

Note The port is set to 10001 at the factory. You must use the same numbers in the device configuration of the chromatography software as in the device, otherwise the connection fails.

- Procedure**
1. Find out port number and change it on the device.
 2. Enter the port number in the chromatography software.

Result The connection is established.

Pin Header Connectors

Remote Connector

- For receiving start, control, and error signals from external devices
- For sending start, control and error signals to external devices

Legend

- ① Display
- ② Events Remote Connector

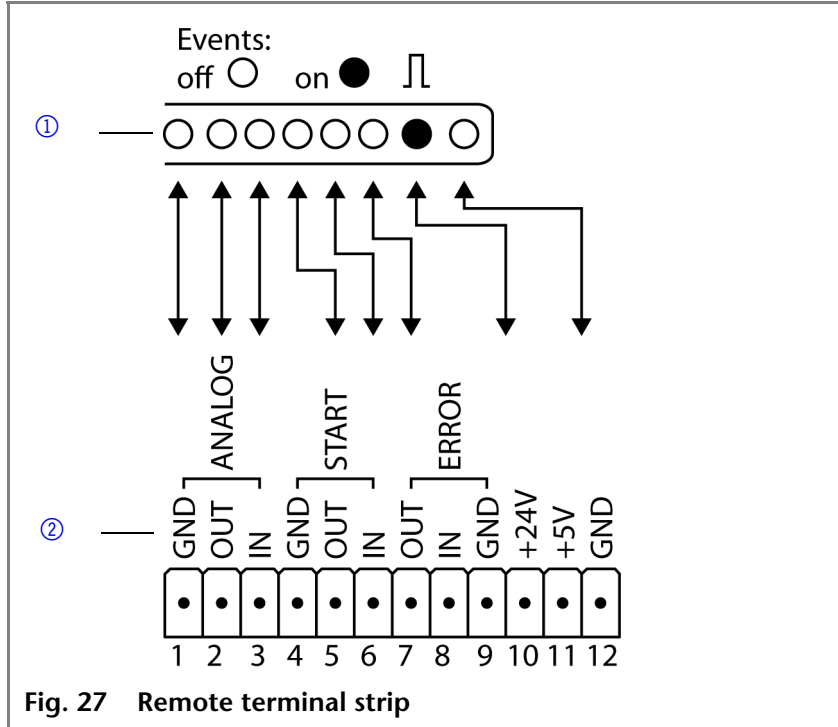

Fig. 27 Remote terminal strip

Explanations for Remote Connector

Signal	Explanation
Analog GND	Reference point of the voltage at the signal inputs.
Analog out	Voltage range 0 – 5 V, scalable
Analog in	Voltage range 0 – 10 V 10 V according to maximum flow rate
Start GND	Reference point of the voltage at the signal inputs.
Start OUT	TTL output Levels: <ul style="list-style-type: none"> ▪ passive 5 V <input type="checkbox"/> ▪ active 0 V <input checked="" type="checkbox"/>
Start IN	TTL input <ul style="list-style-type: none"> ▪ Low active Secure switching threshold at least 10 mA After receiving a signal (short-circuit to ground) from an external device, the device starts. If controlled with software, an electronic trigger is send through the LAN.

Signal	Explanation
Error OUT	TTL output Levels: <ul style="list-style-type: none"> passive 5 V <input type="checkbox"/> active 0 V <input checked="" type="checkbox"/>
Error IN	TTL input <ul style="list-style-type: none"> Low active Secure switching threshold at least 10 mA After receiving a signal (short-circuit to ground) from an external device, an error message appears and the device stops.
Error GND	Reference point of the voltage at the signal inputs.
+24V	Event-controlled switching of 24 V against GND Protection: 24 V – 200 mA
+5V	Provides a voltage of 5 V with respect to GND. This makes it possible to supply a consumer that is switched by an EVENT. Protection: 5 V – 50 mA
GND	Reference point of the voltage at the signal inputs.

Events Connector

For test purposes or in some other cases, it can make sense to manually enter these signals:

- Sending control signals (Events) to external devices
- Opening and closing contacts
- Activating 500 ms pulses

Legend

- ① Display
- ② Events Remote Connector

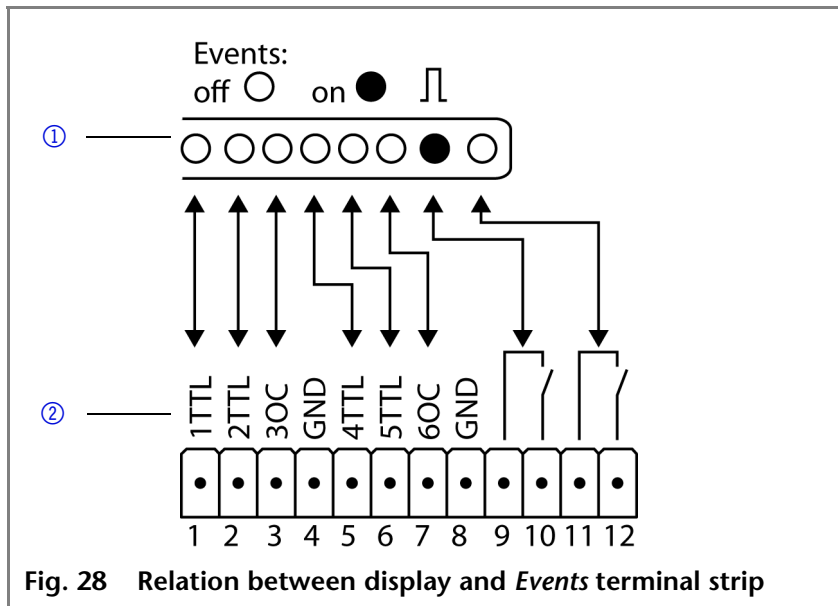











Fig. 28 Relation between display and Events terminal strip

Explanations for Events Connector

Assignment	Connection	Function
	1TTL	TTL-compatible output Levels: <ul style="list-style-type: none"> ▪ passive 0 V <input type="checkbox"/> ▪ active 5 V <input checked="" type="checkbox"/> Pulse: <ul style="list-style-type: none"> ▪ 5 V for at least 1000 ms 
	2TTL	TTL-compatible output Levels: <ul style="list-style-type: none"> ▪ passive 0 V <input type="checkbox"/> ▪ active 5 V <input checked="" type="checkbox"/> Pulse: <ul style="list-style-type: none"> ▪ 5 V for at least 1000 ms 
	3OC	TTL output Levels: <ul style="list-style-type: none"> ▪ passive 0 V <input type="checkbox"/> ▪ active 5 V <input checked="" type="checkbox"/> Pulse: <ul style="list-style-type: none"> ▪ 5 V for at least 1000 ms 
	GND	Reference point of the voltage at the signal inputs.
	4TTL	TTL-compatible output Levels: <ul style="list-style-type: none"> ▪ passive 0 V <input type="checkbox"/> ▪ active 5 V <input checked="" type="checkbox"/> Pulse: <ul style="list-style-type: none"> ▪ 5 V for at least 1000 ms 
	5TTL	TTL-compatible output Levels: <ul style="list-style-type: none"> ▪ passive 0 V <input type="checkbox"/> ▪ active 5 V <input checked="" type="checkbox"/> Pulse: <ul style="list-style-type: none"> ▪ 5 V for at least 1000 ms 
	6OC	TTL output Levels: <ul style="list-style-type: none"> ▪ passive 0 V <input type="checkbox"/> ▪ active 5 V <input checked="" type="checkbox"/> Pulse: <ul style="list-style-type: none"> ▪ 5 V for at least 1000 ms 
	GND	Reference point of the voltage at the signal inputs.

Assignment	Connection	Function
		<p>Relay contact The contact is on a floating basis. Its setting depends on the settings in the Control Unit or software.</p> <p>Steady-rate signal:</p> <ul style="list-style-type: none"> ▪ passive = open relay contact <input type="checkbox"/> ▪ active = closed relay contact <input checked="" type="checkbox"/> <p>Pulse:</p> <ul style="list-style-type: none"> ▪ Closed relay contact for at least 1000 ms  <p>Permissible load of the relay contact: 1 A/ 24 V DC</p>
		<p>Relay contact The contact is on a floating basis. Its setting depends on the settings in the Control Unit or software.</p> <p>Steady-rate signal:</p> <ul style="list-style-type: none"> ▪ passive = open relay contact <input type="checkbox"/> ▪ active = closed relay contact <input checked="" type="checkbox"/> <p>Pulse:</p> <ul style="list-style-type: none"> ▪ Closed relay contact for at least 1000 ms  <p>Permissible load of the relay contact: 1 A/ 24 V DC</p>

Wiring the Terminal Strip

To control one device through another, you use the multi-pin connector. To use remote control, you have to connect cables to the terminal strip (everything comes included with delivery). The single ports are used to exchange control signals.

- Prerequisites**
- The device has been turned off.
 - The power plug has been pulled.

Tools Depressor tool



CAUTION!
Short-circuit hazard.
- Turn off the device before connecting it to the multi-pin connector.
- Pull the power plug.

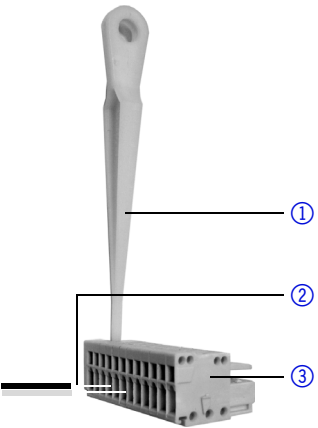

CAUTION!
Electrostatic discharge can destroy the electronics.
Wear a protective bracelet against electrostatic discharge and ground.

Procedure	Process	Figure
	<ol style="list-style-type: none"> 1. Place the terminal strip ③ on a suitable surface. 2. Push the depressor tool ① into the opening on the upper side. 3. Continue pushing the depressor tool down and lead the cable ② into the front end of the terminal strip. 4. Remove the depressor tool. 5. Check whether the cables are tightly attached. 6. Plug the terminal strip onto the multi-pin connector. 	 <p data-bbox="1002 689 1289 721">Fig. 29 terminal strip</p>

Next steps Finish the installation and perform the initial startup.

Analog Control

Analog ports serve for exchanging analog control signals. Reference point for the signals is the connector GND.

- OUT: Device sends signal.
- IN: Device receives signal.

Power Supply

Note The nominal capacity of the connected devices must be maximum 50 % of the power supply to account for larger inrush currents when switching on the modules.

The maximum power input is 100 watts.

- Prerequisites**
- The electrical power supply at the installation site must be connected directly to the nearest main power line.
 - The power must be free from ripple, residual current, voltage peaks and electromagnetic interference.
 - The connectors for the mains voltage are grounded accordingly.
 - The device receives sufficient power with reserve capacity.

The device is intended for use with AC power networks of 100–240 V.

Power cable Use only the enclosed power cable to connect the device to the mains. Replace defective power cables only with accessories from KNAUER. Only use power cables admitted for use in your country.

- Power plug** Make sure that the power plug on the rear of the device is always accessible, so that the device can be disconnected from the power supply.
- Next steps** Finish the installation and connect the device to the mains.

Operation

In this chapter you find information which are relevant for operating the pump.

- Note** Prior to switching on the pump, you should de-aerate it to remove air from capillary and tubing.

Initial Start-Up

Use this checklist to determine whether the detector is ready for the initial start-up:

- Device is positioned in the correct location.
- The power plug has been pulled.

If the device is part of an HPLC system, you should also note the following:

- The network connection to the router is established.
- The chromatography software has been installed by KNAUER or a company authorized by KNAUER.
- The capillary has been connected.

Pump Head

To bring a newly installed pump head into service securely, it should run in prior to its first operation. For this purpose, set the following parameters:

	Pump head 5 ml, 10 ml	Pump head 50 ml
Solvent	H ₂ O (degassed) or ethanol	H ₂ O (degassed) or ethanol
Back pressure	30 MPa (min > 15 MPa)	12 MPa (min > 8 MPa)
Flow rate	2–5 ml/min	5–20 ml/min
Run time	30 min	90 min
Drag	Capillary with inner diameter of 0.1 mm length 2 m	Capillary with inner diameter of 0.1 mm length 1 m

Back pressures higher than 8 MPa are generated by back pressure regulators.

De-Aerating the Pump

Before the pump can be used, it must be de-aerated.

- Mode "Flow on"** The pump can only be de-aerated when switched on because the syringe can only take in liquid in "Flow on" mode. Only then are the valves of a binary pump opened.

Quick suction process For the binary pump, the de-aerating process may take a while during initial start-up because the solvent tubes are filled with liquid for the first time.

- Prerequisite**
- The installation has been completed.
 - The capillary and tubing have been connected.
 - The pump has been switched on.

Tool Syringe with Luer lock



CAUTION!
Damage to the column due to de-aeration!
 - Open the venting screw or remove column.

Procedure

Process	Figure
<ol style="list-style-type: none"> 1. Open the venting screw ① of the pressure sensor. 2. With the syringe, extract fluid through the de-aeration port ②. 	<p>Fig. 30 Venting screw of the pressure sensor</p>

Next steps Start the pump via the Control Unit or the software (option: Purge) with a medium flow rate (50 % of the maximum flow). If the extracted fluid flows continuously, stop suction and close the venting screw.

Result After de-aerating, excess air is removed from the pump head and the capillary.

Switch-On

Note Prior to switching on the pump, you should de-aerate it to remove air from capillary and tubing.

After switching on the pump, the piston backflushing automatically flushes for 15 seconds.

Prerequisite The installation has been completed.



CAUTION!
Possible damage to the device caused by condensed water!
 Allow device to acclimate for 3 h, before it is connected to power supply and taken into operation.



CAUTION!
Damage to the pump head in case it runs dry.
 Ensure that liquids runs through pump head and piston backflushing.

- Procedure**
1. Connect the device to the power supply.
 2. Switch the power supply on.
 3. Wait until the pump has completed the self-test.
 4. Start the pump at a medium flow rate.

Next steps Operate the pump.

Control

There are several options for controlling the device:

- Chromatography software
- Control Unit
- App (Mobile Control)

Note It is not possible to use two options simultaneously. If the device is connected to the software, it cannot be controlled via Control Unit or Mobile Control, etc.

Control with Chromatography Software

To control the device with software, you have to establish a connection between the LAN port and a computer.

Devices can be controlled with e.g. OpenLAB EZChrom edition version A.04.05 or higher, or with ClarityChrom version 5.0.2 or higher. You find a detailed description on chromatography software in a corresponding user manual.

Control with Control Unit



To control the device using the Control Unit, connect the cable of the Control Unit to the device. The Control Unit is an optional accessory. You find a detailed description on the Control Unit in its accompanying user manual.

Control with Mobile Control

The Mobile Control is an app which can be installed on your computer or tablet computer. To control the device using the Mobile Control, connect the computer or tablet computer to a wireless LAN router. You find a detailed description on the Mobile Control in its accompanying user manual.

Meaning of the LEDs

There are three LEDs and a switch on the front of the device.

Legend

- ① Left LED
- ② Center LED
- ③ Right LED
- ④ Power switch

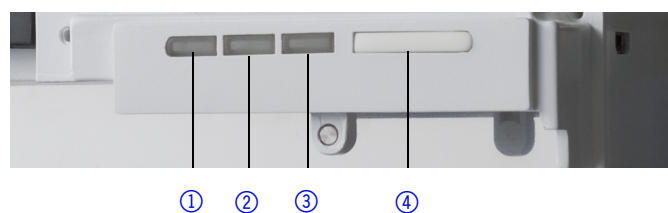

Fig. 31 LEDs and switch on the front of the device

The LEDs can have different colors depending on the operating conditions.

Standby To start the standby, keep the switch pressed for 5 seconds.

Note Malfunctioning system after repeated standby possible. After repeatedly using the standby, switch off the power switch and back on again, to reset the data storage.

	Color	Operating condition	Operation
Left LED	red	Error Message	<ul style="list-style-type: none"> ▪ Check the system. ▪ Shortly press the switch to deactivate the error message.
	Center LED	does not light	Device has been switched off.
	flashes green	Device not ready for operation.	<ul style="list-style-type: none"> ▪ Wait until the device is ready.
	green	Device is switched on.	
Right LED	green	Device active or ready for measuring.	
	blue	Device in standby	<ul style="list-style-type: none"> ▪ Press the switch to end the standby.

Functionality Tests IQ and OQ

Installation Qualification (IQ) The customer may request the Installation Qualification, which is free of charge. In case of a request, the Technical Support of KNAUER or from a provider authorized by KNAUER performs this functionality test during the installation. The Installation Qualification is a standardized document that comes as part of the delivery and includes the following:

- confirmation of flawless condition at delivery
- check if the delivery is complete
- certification on the functionality of the device

Operation Qualification (OQ) The Operation Qualification includes an extensive functionality test and must be purchased from the manufacturer. Contact the KNAUER Sales Department to request an offer. The Operation Qualification is a standardized KNAUER document and includes the following:

- definition of customer requirements and acceptance terms
- documentation on device specifications
- device functionality check at installation site

Test Intervals To make sure that the device operates within the specified range, you should test the device using the Operation Qualification at following intervals:

Average Useful Life	OQ Test
1 to 5 days/week:	Every 6 months
More than 5 days/week or 24 hours/day:	Every 3 months
Operation with buffer solutions or other salt solutions:	Every 3 months



Execution The test can be carried out either by the Technical Support of KNAUER or from a provider authorized by KNAUER.

Troubleshooting

- First measures**
1. Check all cables.
 2. Check all screw fittings.
 3. Check whether air has gotten into the supply lines.
 4. Check device for leaks.
 5. Pay attention to system messages.

LAN

Go through the following steps, in case no connection between the computer and the devices can be established. Check after each step if the problem is solved. If the problem cannot be located, call the Technical Support.

<p>1. Check the status of the LAN connection in the Windows task bar:</p> <ul style="list-style-type: none"> ▪  Connected ▪  Connection not established <p>If no connection was established, test the following:</p> <ul style="list-style-type: none"> ▪ Is the router switched on? ▪ Is the patch cable connected correctly to the router and the computer? 	<input type="checkbox"/>
<p>2. Check the router settings:</p> <ul style="list-style-type: none"> ▪ Is the router set to DHCP server? ▪ Is the IP address range sufficient for all the connected devices? 	<input type="checkbox"/>
<p>3. Check all connections:</p> <ul style="list-style-type: none"> ▪ Are the patch cable connected to the LAN ports and not the WAN port? ▪ Are all cable connections between devices and router correct? ▪ Are the cables plugged in tightly? 	<input type="checkbox"/>

<p>4. If the router is integrated into a company network, pull out the patch cable from the WAN port.</p> <ul style="list-style-type: none"> ▪ Can the devices communicate with the computer, even though the router is disconnected from the company network? 	<input type="checkbox"/>
<p>5. In case you own a Control Unit, check the settings in the menu <i>Setup > Network</i>.</p> <ul style="list-style-type: none"> ▪ Is <i>LAN-DHCP</i> set for controlling? ▪ Did the device receive an IP address? 	<input type="checkbox"/>
<p>6. Turn off all devices, router, and computer. Firstly, turn on the router and secondly turn on the devices and the computer.</p> <ul style="list-style-type: none"> ▪ Has this been successful? 	<input type="checkbox"/>
<p>7. Replace the patch cable to the device with that no connection could be established.</p> <ul style="list-style-type: none"> ▪ Has this been successful? 	<input type="checkbox"/>
<p>8. Make sure that the IP port of the device matches the port in the chromatography software.</p>	<input type="checkbox"/>

Possible Problems and Troubleshooting

Error	Solution
Device cannot be switched on	Inspect the power cable to ensure that it is plugged into the power supply.
When purging, the pump switches off.	Check if the venting screw on the pressure sensor is turned up.
Pump does not transport solvent	<ul style="list-style-type: none"> ▪ Purge the pump head to remove the air bubbles. ▪ Clean the check valves. ▪ Exchange the check valves. ▪ If the pump head seals are defective, solvent enters the piston backflushing; inform the technical support of the manufacturer. ▪ Exchange the pump head.

Pressure and flow rate variations	<ul style="list-style-type: none"> ▪ Purge the pump head to remove excess air. ▪ Always tighten the inlet screw fittings and outlet screw fittings on the pump head with a torque wrench. <ul style="list-style-type: none"> ▪ 5 Nm torque for a stainless steel pump head ▪ 3.5 Nm torque for a ceramic pump head ▪ Clean the check valves. ▪ Exchange the check valves. ▪ Exchange the pump head. ▪ Contact the Technical Support.
Pump head leaks	<ul style="list-style-type: none"> ▪ Inspect the inlet and outlet screw fittings of the pump head. ▪ If the pump head seals are defective, solvent enters the piston backflushing; inform the Technical Support. ▪ Exchange the pump head.
Flow rate is not correct	<p>Check the following options:</p> <ul style="list-style-type: none"> ▪ Check the data for the solvent compressibility. ▪ Clean the check valves. ▪ Exchange the check valves.
System error	Switch off the device to reset the device's data storage and restart it afterwards.

System Messages

If other system messages are displayed besides those listed below, please turn the device off and then on. If this system message occurs repeatedly, contact the Technical Support.

The system messages are in alphabetical order:

	System message	
A	"A line with this time already exists: edit the time please"	Correct the time entry.
C	"Cannot delete active program/link"	Pause the program/link. Only then can the link and, subsequently, the program used in the link be deleted.
	"Cannot edit program from the running link"	Pause the link. Afterwards, the program can be changed.
	"Cannot initialize LAN"	Check cables and connections in local area network.

	System message	
	"Cannot operate with an empty link"	Create a link.
	"Cannot purge during the run"	End method and start purging.
	"Cannot read data from FRAM"	Switch the device off and on. If this system message occurs repeatedly, contact the Technical Support.
	"Cannot start time table"	Check the data on the device's display or in the opened program.
	"Cannot use non-existing component"	Check if the channels to be mixed are set correctly in the <i>Setup</i> section of the device or in the <i>Instrument Setup</i> of the chromatography software.
	"Cannot write data on FRAM"	Restart the device. If this system message occurs repeatedly, contact the Technical Support.
	"Component settings not compatible with gradient setup"	Change the <i>Setup</i> settings or change the gradient in the program or in <i>Setup</i> .
E	"Error input activated"	Eliminate the short circuit connected to 'Error In'.
F	"Flow max in the program is not compatible with the current pump head"	When entering the flow, note the maximum flow of the pump head and only enter values inside this range.
G	"GUI communication failed"	Restart the device. If this system message occurs repeatedly, contact the Technical Support.
H	"HPG B component not present"	
	"HPG B: Command timeout"	
	"HPG B: incompatible pump head type"	
	"HPG B: Service active"	
I	"Instrument remote controlled"	This entry is not executable. Quit software.
	"Invalid index in time table"	Change the entry in the program line.
	"Invalid line number"	
	"Invalid link"	Create a link or use an existing link.

	System message	
L	"Leak sensor not present"	Restart the device. If the leak sensor cannot be found, contact the Technical Support.
	"Leak was detected"	Switch off the device. Remove the leak and start the device afterwards.
	"Line in time table is empty"	Edit the program line.
	"Link is running"	Wait until the link has been completed, then change the link or delete it.
M	"Maximum pressure: System stopped"	<ul style="list-style-type: none"> ▪ Check whether the connected capillary and connectors are clogged. ▪ Adjust the maximum pressure limit. ▪ Restart the system.
	"Minimum pressure: System stopped"	<ul style="list-style-type: none"> ▪ Increase the pressure or adjust the lower pressure limit. ▪ Restart the system.
	"Motor failure: max current"	Restart the device. If this system message occurs repeatedly, contact the Technical Support.
"Motor failure: position error"		
"Motor failure"		
N	"No link available. Pls edit link first"	Create a link and edit it.
	"No link available"	
	"No valid pump head type detected; 50ml pump head is set."	<ul style="list-style-type: none"> ▪ Restart the device. ▪ Check whether a pump head with RFID recognition has been installed. ▪ Repeat the automatic configuration step in the chromatography software. ▪ Remove pump head, clean it and re-install it.
	"Non-existing component is set to non-0 value"	Switch on the channel or edit the data using the chromatography software.

System message																			
P	<table border="1"> <tr> <td style="width: 30%;">"Not enough space to store link"</td> <td> <ul style="list-style-type: none"> ▪ Check the pump. ▪ Check the number of program lines - a maximum of 100 program lines are possible. </td> </tr> <tr> <td>"Not enough space to store program"</td> <td> <ul style="list-style-type: none"> ▪ Check the pump ▪ Check the number of program lines - a maximum of 100 program lines are possible. </td> </tr> <tr> <td>"Not in HPG mode"</td> <td>Select HPG mode.</td> </tr> <tr> <td>"Pressure max in the program is not compatible with the current pump head"</td> <td>Note the maximum pressure of the pump head.</td> </tr> <tr> <td>"Program does not exist, please edit the program number"</td> <td>Create and edit a program.</td> </tr> <tr> <td>"Program is running"</td> <td>Quit program or wait until program has been completed.</td> </tr> <tr> <td>"Pump head type: head data uninitialized"</td> <td> <ul style="list-style-type: none"> ▪ Restart the device. ▪ Check whether a pump head with RFID recognition has been installed. ▪ Repeat the automatic configuration step in the chromatography software. ▪ Remove pump head, clean it and re-install it. </td> </tr> <tr> <td>"Pump head type: read failed"</td> <td> <ul style="list-style-type: none"> ▪ Restart the device. ▪ Repeat the automatic configuration step in the chromatography software. ▪ Remove pump head, clean it and re-install it. ▪ If this system message occurs repeatedly, contact the Technical Support. </td> </tr> <tr> <td>"Pump head type: RFID hardware not present or failed"</td> <td>Pump head without RFID detection: If necessary, replace pump head.</td> </tr> </table>	"Not enough space to store link"	<ul style="list-style-type: none"> ▪ Check the pump. ▪ Check the number of program lines - a maximum of 100 program lines are possible. 	"Not enough space to store program"	<ul style="list-style-type: none"> ▪ Check the pump ▪ Check the number of program lines - a maximum of 100 program lines are possible. 	"Not in HPG mode"	Select HPG mode.	"Pressure max in the program is not compatible with the current pump head"	Note the maximum pressure of the pump head.	"Program does not exist, please edit the program number"	Create and edit a program.	"Program is running"	Quit program or wait until program has been completed.	"Pump head type: head data uninitialized"	<ul style="list-style-type: none"> ▪ Restart the device. ▪ Check whether a pump head with RFID recognition has been installed. ▪ Repeat the automatic configuration step in the chromatography software. ▪ Remove pump head, clean it and re-install it. 	"Pump head type: read failed"	<ul style="list-style-type: none"> ▪ Restart the device. ▪ Repeat the automatic configuration step in the chromatography software. ▪ Remove pump head, clean it and re-install it. ▪ If this system message occurs repeatedly, contact the Technical Support. 	"Pump head type: RFID hardware not present or failed"	Pump head without RFID detection: If necessary, replace pump head.
"Not enough space to store link"	<ul style="list-style-type: none"> ▪ Check the pump. ▪ Check the number of program lines - a maximum of 100 program lines are possible. 																		
"Not enough space to store program"	<ul style="list-style-type: none"> ▪ Check the pump ▪ Check the number of program lines - a maximum of 100 program lines are possible. 																		
"Not in HPG mode"	Select HPG mode.																		
"Pressure max in the program is not compatible with the current pump head"	Note the maximum pressure of the pump head.																		
"Program does not exist, please edit the program number"	Create and edit a program.																		
"Program is running"	Quit program or wait until program has been completed.																		
"Pump head type: head data uninitialized"	<ul style="list-style-type: none"> ▪ Restart the device. ▪ Check whether a pump head with RFID recognition has been installed. ▪ Repeat the automatic configuration step in the chromatography software. ▪ Remove pump head, clean it and re-install it. 																		
"Pump head type: read failed"	<ul style="list-style-type: none"> ▪ Restart the device. ▪ Repeat the automatic configuration step in the chromatography software. ▪ Remove pump head, clean it and re-install it. ▪ If this system message occurs repeatedly, contact the Technical Support. 																		
"Pump head type: RFID hardware not present or failed"	Pump head without RFID detection: If necessary, replace pump head.																		

System message	
	<p>"Pump head type: write failed"</p> <ul style="list-style-type: none"> ▪ Restart the device. ▪ Repeat the automatic configuration step in the chromatography software. ▪ Remove pump head, clean it and re-install it. ▪ If this system message occurs repeatedly, contact the Technical Support.
S	<p>"SetPoint in the program is not compatible with the current PH PMax"</p> <p>Note the maximum pressure of the pump head.</p>
T	<p>"This link is used in WAKEUP"</p> <p>First quit or delete wakeup program (wu = Wake Up), then edit or delete link.</p>
	<p>"This program is used in a link"</p> <p>First pause or delete the link, then edit or delete data using the chromatography software.</p>
	<p>"This program is used in WAKEUP"</p> <p>First quit or delete wakeup program (wu = Wake Up), then edit or delete data by means of the chromatography software.</p>
	<p>"Too many lines in program"</p> <p>Check the number of program lines. A maximum of 100 program lines are possible.</p>
U	<p>"Unable to attain min. flow setpoint"</p> <p>Confirm, pump continues running.</p>
	<p>"Unable to attain pressure setpoint"</p> <p>The entered pressure cannot be achieved with the maximum flow set in the <i>Constant Pressure</i> mode.</p> <ul style="list-style-type: none"> ▪ Check for leaks. ▪ Increase the upper flow level. ▪ Reduce the working pressure.
	<p>"Unknown pump head type"</p> <ul style="list-style-type: none"> ▪ Check the pump head. ▪ Check whether a pump head with RFID recognition has been installed. ▪ If this system message occurs repeatedly, contact the Technical Support.
W	<p>"Wake up time already passed"</p> <p>Correct the entry for date or otherwise time.</p>

Maintenance and Care

Organic solvents are toxic above a certain concentration. Ensure that work areas are always well-ventilated! When performing maintenance tasks on the device, always wear safety glasses with side protection, protective gloves, and a lab coat.

All wetter components of a device, e. g. flow cells of detectors or pump heads and pressure sensors for pumps, have to be flushed with isopropanol first and water afterwards before being maintained, disassembled or disposed.

Opening the device The device may only be opened by the KNAUER Technical Support or any company authorized by KNAUER.



CAUTION!

Performing maintenance tasks on a switched on device can cause damage to the device. Switch off the device and pull the power plug.



CAUTION! Device damage because of leaks. If leaks occur after maintenance and assembly, replace the capillary connections with new ones.

Users may perform the following maintenance tasks themselves:

- Replacing the pump head
- Replacing the check valves of the pumps
- Replacing the Inline filter of the pressure sensor
- Replacing the Mixer

Proper maintenance of your HPLC device will ensure successful analyses and reproducible results.

Contact with the Technical Support

If you have any technical questions regarding KNAUER hardware or software, please use one of the contact options below:

Technical Support hotline:

European hotline Languages: Available by telephone in German or English: 8 am to 5 pm (CET)
Phone: +49 30 809727-111
Telefax: +49 30 8015010

E-mail contact: support@knauer.net

Maintenance Contract

The following maintenance work on the device may only be performed by KNAUER or a company authorized by KNAUER and is covered by a separate maintenance contract:

- Opening the device or removing housing parts

Maintenance Intervals

Operating hours The Control Unit, the Mobile Control and the different software products (e.g. ClarityChrom® or OpenLAB®) enable you to display or read out the operating time of the pump. You find a detailed description on how to display or read out GLP data in the respective user manuals.

Operating hours	Measures
1000	<ul style="list-style-type: none"> ▪ Check the torque of the screw fittings ▪ Clean the pistons of the pump ▪ Check the check valves of the pump head
5000	<ul style="list-style-type: none"> ▪ Replace all seals ▪ Clean the check valves of the pump head
10000	<ul style="list-style-type: none"> ▪ Replace pump head spare parts ▪ Replace the check valves of the pump head

Cleaning and Caring for the Device



CAUTION!
Intruding liquids can cause damage to the device.
 - Place solvent bottles next to the device or in a solvent tray.
 - Moisten the cleaning cloth only slightly.

All smooth surfaces of the device can be cleaned with a mild, commercially available cleaning solution, or with isopropanol.

Checking the Fittings

Check if all fittings are tight. If fittings are not tight, re-tighten fittings. Note the torque applicable for each fitting in order to not damage any components.

Pump head inlet and outlet	Torque
Stainless steel fittings	7.5 Nm
PEEK fittings	3.5 Nm

Inline filter fittings	Torque
Stainless steel fittings	7.5 Nm
PEEK fittings	3.5 Nm

Capillary fittings	Torque
Stainless steel fittings	5 Nm

Capillary fittings	Torque
PEEK fittings	0.5 Nm

Flushing the Pump

Generally, the pump and all its components (valves, degasser) should be flushed after each operation. Also, flush the pump to clean the tubing before changing the solvent and to remove air bubbles in the capillary and tubing. If buffer solution has been employed, note that the buffer solution and the flushing solution are compatible.



CAUTION!
Damage to the pump head by residual chemicals. If the pump head is stored and re-used later, flush it and fill it with isopropanol. Afterwards, seal the inlets and outlets with cap fittings.

- When buffers have been used, flush with water.
- When aggressive solvents have been used, flush with isopropanol.

Auxiliary material Flushing solution, silicone tube

Procedure

Process	Figure
<ol style="list-style-type: none"> 1. Immerse the solvent tubing into the flushing solution. 2. Plug a silicone tube onto the venting nozzle ② of the pressure sensor. 3. Open the venting screw ①. 4. Start the pump at a medium flow rate. 	<p>Fig. 32 Pressure sensor</p>

Next steps Bring the pump into operation again.

Putting the Pump Out of Operation

The pump is designed for use with different solvents. If the pump is out of operation for several weeks, residual solvent can cause damage. It is therefore recommended that all components of the pump be flushed, the solvent used be removed completely and that all components and tubes of the pump be filled with isopropanol. All open connectors should be sealed. Capillary and tubing which connects single components of the pump should not be removed.

- Prerequisite**
- The pump has been rinsed.
 - The pump has been switched off.

Tool Open-end wrench, size 10

Procedure	Process
	<ol style="list-style-type: none"> 1. Remove the solvent tubing and seal all open connectors with cap fittings. 2. Remove the pump from the HPLC flow system and seal the open connector of the pressure sensor (isocratic version) or the mixer (binary or quaternary version) with cap fittings.

Next steps Choose a storage location according to the ambient conditions listed in the respective chapter of this user manual.

Storage

Note that prior to storing all tubes and capillary should be emptied or filled with an appropriate flushing solution (e.g. isopropanol). To prevent algae formation, do not use pure water. Seal all inlets and outlets with cap fittings.

The device can be stored under the following ambient conditions:

- Temperature range 10–40 °C (50–104 °F)
- Humidity below 90 %, non-condensing

Disconnecting from Power Supply

Prerequisite The device has been switched off.

Procedure	Process
	<ol style="list-style-type: none"> 1. Pull the power plug from the socket and afterwards remove from the device. 2. Pack the power cable with the device.

Next steps Disconnect all remaining electrical connections, remove the pump head and pack the device for transport or storage.

Preparing the Pump Head for Storage

Prerequisites The power plug has been pulled.

- Auxiliary material**
- Syringe
 - Flushing solution:



CAUTION!
Damage to the pump head by residual chemicals. If the pump head is stored and re-used later, flush it and fill it with isopropanol. Afterwards, seal the inlets and outlets with cap fittings.

Procedure

Process
<ol style="list-style-type: none"> 1. Fill the flushing solution into a syringe and inject into the capillary at the pump head inlet. Leave it for 5 minutes. 2. Rinse with water. 3. Flush the pump head with isopropanol. 4. Seal the inlets and outlets with cap fittings.

Next steps Dismount the pump head.

Dismounting the Pump Head

- Prerequisite**
- The pump head has been purged.
 - The tubes at the inlet and outlet have been removed.
 - The pump head's inlet and outlet have been sealed with cap fittings.

- Tools**
- Allen wrench
 - Open-end wrench, size 1/4"
 - Open-end wrench, size 13



WARNING!
 Aggressive or toxic solvent residue can irritate the skin!
 Wear protective gloves.
 Flush the pump head before exchanging it.



CAUTION!
 Damage to the pump head by residual chemicals. If the pump head is stored and re-used later, flush it and fill it with isopropanol. Afterwards, seal the inlets and outlets with cap fittings.



CAUTION!
 Damage to the pistons if they tilt. Undo or tighten diagonally opposite screws evenly by one turn each at a time.

Procedure

Process	Figure
<ol style="list-style-type: none"> 1. Loosen the capillary connectors ① at the outlet. Remove the capillary. 1. Fixate the outlet fitting ① with an open-end wrench (size 13). 2. Loosen the fitting ② with an open-end wrench (size 1/4"). 	<p>Fig. 33 Fitting at the outlet of the pump head</p>

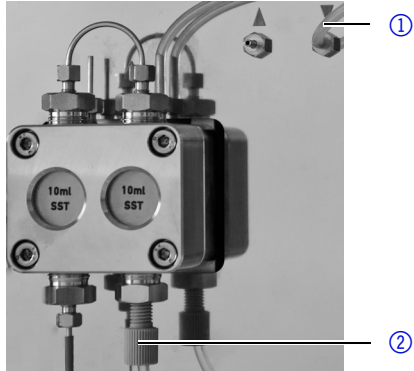
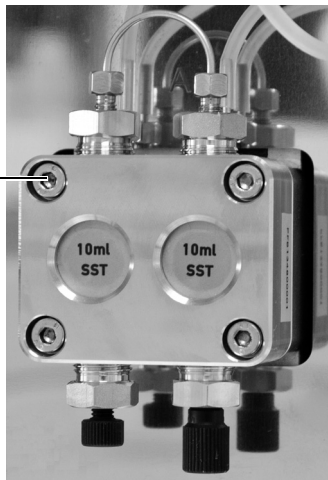
Procedure	Process	Figure
	<p>3. Remove the solvent line ② from the solvent inlet.</p> <p>4. Disconnect the tubes of the piston backflushing ① from the flush pump and the pump head.</p>	 <p>Fig. 34 Tubing of the piston backflushing</p>
	<p>5. Using the Allen wrench, unscrew the 4 screws ① subsequently by one turn.</p> <p>6. Fixate the pump head with your hand and remove the screws.</p> <p>7. Lift off the pump head.</p>	 <p>Fig. 35 Screws of the pump head</p>

Next steps Maintain the check valves or install a new pump head.

Check Valves

Clogged check valves do not open and close properly. They cause pressure fluctuations and irregular flow. If it is impossible to clean the check valves, replace the whole unit.

- Procedure**
- Remove the check valve
 - Clean the check valve
 - Install the check valve

Removing the Check Valve

The pump head is equipped with two check valves.

- Prerequisite**
- The pump head has been purged.
 - The capillary and tubing have been removed.
 - The pump head has been removed.

- Tools**
- Open-end wrench, size 13

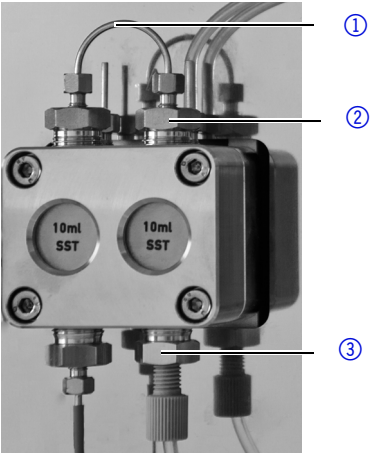
Procedure	Process	Figure
	<ol style="list-style-type: none"> 1. Unscrew and remove the capillary connector ①. 1. Loosen the outlet fitting ② with the open-end wrench. 2. Remove the first check valve. 3. Loosen the inlet fitting ③ with the open-end wrench. 4. Remove the second check valve. 	 <p data-bbox="963 701 1342 763">Fig. 36 Check valve in pump head</p>

Next steps Clean the check valves.

Cleaning the Check Valves

In order to be cleaned, the check valves are not disassembled but are cleaned as a whole.

Prerequisite Both check valves have been removed.

Procedure	Process
	<ol style="list-style-type: none"> 1. Place each check valve into a beaker with solvent, e.g. isopropanol. 2. Put the beaker with the check valve in an ultrasonic bath for at least 10 minutes. 3. Let the check valves dry afterwards.

Next steps Insert both cleaned check valves.

Installing the Check Valve

Insert the check valves in the direction of the flow. The notch of the check valve points downward.

Normal phase Insert the check valves in the direction of the flow. The arrow on the check valve points upward.

Prerequisite The check valves have dried.



CAUTION!
Damage to components caused by overtightened fittings!

Note the torque of the fittings:
 - For stainless-steel fittings: 5 Nm
 - For PEEK fittings: maximum 1 Nm or finger-tight and an additional quarter of a turn with appropriate pliers.

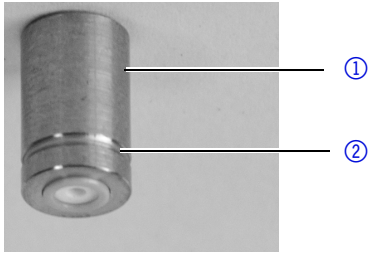
Procedure	Process	Figure
	<ol style="list-style-type: none"> 1. Insert the check valves ① in such a way that the notch of the check valve ② points downward. 2. Screw in inlet and outlet fittings and tighten them with a torque wrench and the respective torque. 	 <p data-bbox="963 495 1230 528">Fig. 37 Check valve</p>

Next steps Re-install the pump head.

Replacing the Inline Filter

Clogged inline filters inside of the pressure sensor can cause pressure fluctuations and irregular flow. Inline filters are not cleaned but exchanged as an assembly.

- Procedure**
1. Remove the capillary below the inline filter of the pressure sensor.
 2. Loosen the fitting of the inline filter and remove manually.
 3. Insert a new inline filter cartridge.

Removing the Inline Filter

Below the pressure sensor, you find the fitting of the inline filter.

Prerequisite The pump has been rinsed.

- Tools**
- Open-end wrench, size 1/4"
 - Open-end wrench, size 13

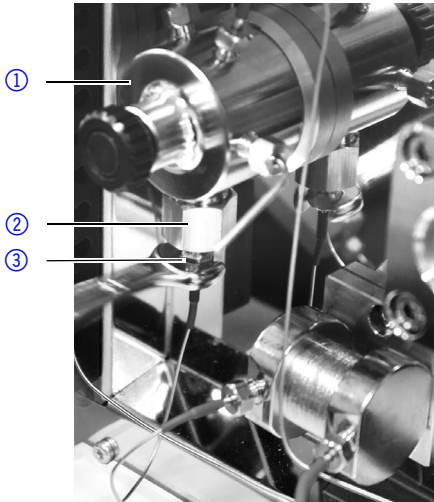
Procedure	Process	Figure
	<ol style="list-style-type: none"> 1. Fixate the outlet fitting ② with an open-end wrench (size 13). 2. Loosen the fitting ③ below the inline filter ② of the pressure sensor ① with the open-end wrench (size 1/4"). 	 <p data-bbox="963 1957 1353 2018">Fig. 38 Loosen the capillary below the inline filter</p>

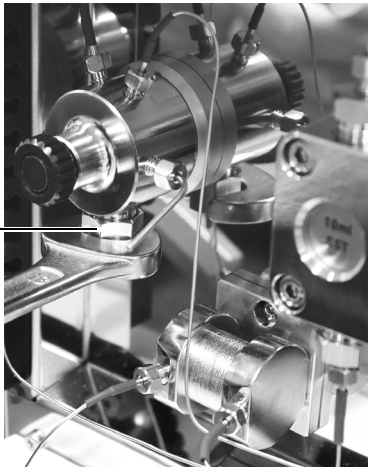
<p>3. Loosen the fitting of the inline filter ① with the open-end wrench (size 13) and remove manually.</p> <p>4. Remove clogged inline filter cartridge.</p>	 <p>Fig. 39 Loosen the inline filter below the pressure sensor.</p>
---	---

Next steps Insert the new inline filter cartridge.

Inserting the new Inline Filter Cartridge.

The flow direction is designated on inline filter cartridges. The inline filter and fitting are inserted into the pressure sensor in such a way that the designating notch always points upwards.

- Prerequisite** ▪ None
- Tool** ▪ Torque wrench

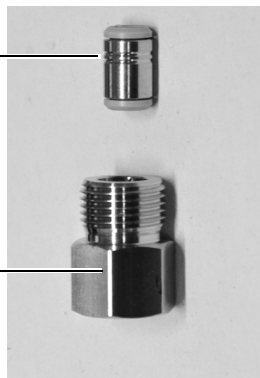

CAUTION!
Damage to components caused by overtightened fittings!
Note the torque of the fittings:
 - For stainless-steel fittings: 5 Nm
 - For PEEK fittings: 1 Nm

Procedure	Process	Figure
	<p>1. Insert the inline filter cartridge with the designating notch pointing upwards ① into the fitting ② .</p> <p>2. Manually, screw the fitting with the inline filter cartridge in the pressure sensor and tighten with a torque wrench using the appropriate torque.</p>	 <p>Fig. 40 Inserting the inline filter cartridge into the fitting</p>

Next steps Reinstall the capillary at the pressure sensor below the fitting of the inline filter.

Replacing the Mixer

A clogged mixer can cause pressure fluctuations and irregular flow. The mixer is replaced completely as an assembly.

- Procedure**
1. Remove capillary from the inlet and outlet of the mixer.
 2. Remove the screws from the front of the mixer.
 3. Remove the mixer
 4. Install new mixer

Prerequisite None

- Tools**
- Open-end wrench, size 1/4"
 - Allen wrench, 2 mm and 2.5 mm
 - Torque wrench





CAUTION!

Damage to components caused by overtightened fittings!

Note the torque of the fittings:

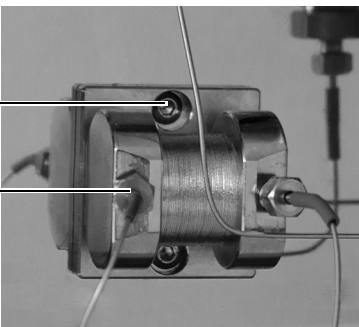
- For stainless-steel fittings: 5 Nm
- For PEEK fittings: 1 Nm

Procedure	Process	Figure
	<ol style="list-style-type: none"> 1. Remove capillary ② at the inlet and outlet of the mixer 2. Remove the screws ① from the front of the mixer and remove the mixer. 3. Install new mixer. 4. Manually, screw the fittings of the capillary in the mixer.T 5. ighten with a torque wrench using the appropriate torque. 	 <p>Fig. 41 Mixer</p>  <p>Fig. 42 Mixer bio</p>

Next steps Bring the device into operation again.

Removing a Leak

Prerequisite If liquid enters the inside of the device, switch off the device. If this is not the case, it is not necessary to switch off the device.

Auxiliary material Cloth for drying the leak sensor

Procedure	Process
	<ol style="list-style-type: none"> 1. Remove the leak. 2. Dry the leak tray. 3. Acknowledge the system error via Control Unit, Mobile Control, or the standby button (only in standalone mode).

Next steps Bring the device into operation again.

Technical Data

P 6.1L Isocratic

Setup	Pump type	Isocratic analytical HPLC pump
	Variants of the pump head	5 ml/min stainless steel 10 ml/min stainless steel 50 ml/min stainless steel 10 ml/min ceramic 50 ml/min ceramic
	Delay volume	60 µl (for 10 ml/min)
Weight	Weight	11.5 kg

P 6.1L Binary

Setup	Pump type	Binary analytical HPLC pump with degasser
	Variants of the pump head	5 ml/min stainless steel 10 ml/min stainless steel 10 ml/min ceramic 10 ml/min stainless steel for normal phase applications
	Degasser	2 channels
	Solvent Selection valve	2 x 2 channels
	Weight	Weight
Gradient formation		High-pressure binary mixing

Mixer	Gradient range	0–100 % 5–95 % (recommended)
	Minimum increment	0.1 %
	HPG: gradient accuracy	± 0.3 % (measured at 1 ml/min, 150 bar, ethanol/caffeine tracer) ± 1 % (5–95 %, measured at 0.1–10 ml/min, water/caffeine tracer)
	HPG: gradient precision	< 0.1 % RSD (measured at 1 ml/min, 0.3 % RSD overall, based on retention time at constant room temperature)
	Mixing volume	50, 100, 200 µl 250 µl (metal-free)
	Delay volume	110 µl (dependent of mixer) 410 µl (metall-free)

P 6.1L Quaternary

Setup	Pump type	Quaternary analytical HPLC pump with degasser	
	Variants of the pump head	5 ml/min stainless steel 10 ml/min stainless steel 10 ml/min ceramic	
Weight	Degasser	4 channels, Teflon® AF	
	Special feature	Automatic adaption of LPG cycle time	
	Weight	12.7 kg	
	Gradient formation	Gradient formation	Low-pressure quaternary mixing
		Gradient range	0–100 % 1–99 % (recommended)
		Minimum increment	0.1 %.
		LPG: gradient accuracy	± 0.3 % (measured at 1 ml/min, 150 bar, ethanol/caffeine tracer) ± 2 % (1–99 %, measured at 5–50 % of the flow range, water/caffeine tracer)
LPG: gradient precision		< 0.1 % RSD (measured at 1 ml/min, 0.5 % RSD overall, based on retention time at constant room temperature)	
Mixer	Mixing volume	50, 100, 200 µl 250 µl (metal-free)	
	Delay volume	210 µl (dependent of mixer) 410 µl (metal-free)	

Pump Heads

Flow rate range	5 ml pump head	0.001 ml/min–2 m/min
	10 ml pump head	0.001 ml/min–10 ml/min 0.02–10 ml/min (recommended)
	50 ml pump head	0.001 ml/min–50 ml/min 0.1 ml/min–40 ml/min (recommended)
Maximum delivery pressure	5 ml pump head	100 Mpa (1000 bar, 14504 psi) up to 2 ml/min, 70 MPa (700 bar, 10150 psi)
	10 ml pump head	Stainless steel 70 Mpa (700 bar, 10150 psi) up to 5 ml/min, 40 MPa (400 bar, 5800 psi) Ceramic 40 MPa (400 bar, 5800 psi)
	50 ml pump head	20 MPa (200 bar, 2900 psi)

P 6.1L General

Solvent conveyance	Variants	Isocratic HPLC pump Quaternary low-pressure gradient pump Binary high-pressure gradient pump
	Conveyance	Double-piston pump
	Pulsation compensation	Active pressure and pulsation compensation
	Pulsation	< 2 % amplitude (typically < 1.3 %) or < 0.3 MPa (3 bar), whatever is greater, at 1 ml/min ethanol, at all pressures > 1 MPa (10 bar, 147 psi)
	Flow rate range	0.001–10 ml/min 0.02–10 ml/min (recommended) 0.01–50 ml/min 0.1–40 ml/min (recommended)
	Flow rate increment	0.001 ml/min
	Flow rate accuracy	± 1 % (measured at 5–80 % of flow range, using ethanol)
	Flow rate precision	< 0.1 % RSD (based on retention time at constant room temperature)
	Piston seal washing	Standard
	System protection	Soft start, P_{\min} and P_{\max} are programmable

Degasser module	Wetted materials	Stainless steel, graphite fiber-reinforced PTFE, FKM, PEEK, sapphire, aluminium oxide (Al ₂ O ₃)
	Degasser channels	2 channels, Teflon® AF
	Degasser maximum flow rate	10 ml/min
	Degasser method	Gas permeation through Teflon® AF amorphous fluoropolymer membrane
	Degasser efficiency	< 0.5 ppm dissolved O ₂ at 1 ml/min
	Degassing chamber volume	480 µl volume per channel
	Solvent applicability	Universal, with the exception of hydrochloric acid and halogenated hydrocarbons - in particular hexafluoroisopropanol (HFIP)
	Wetted materials	PEEK, Tefzel®, Teflon® AF
Communication	Vacuum chamber	Polypropylene and stainless steel
	Vacuum pump	Low hysteresis behavior
	Control	<ul style="list-style-type: none"> ▪ LAN ▪ Analog and event control ▪ Control Unit ▪ Mobile Control
	Analog input	0–10 V
	Analog control input	Flow rate
	Level / event outputs	8 event outputs (TTL, OC, Relais) and 24 V
	Programing	19 programs + 9 links + 1 <i>WAKE UP</i> program
	GLP	RFID pump head recognition, detailed report
Technical parameters	Display	3 LEDs
	Leak sensor	Yes
	Degree of protection	IP-20
	Dimensions	361 mm x 208.2 mm x 523 mm (width x height x depth)
	Power supply	Input
Output		50–60 Hz

Operating Environment	Maximum power consumption	100 Watt
	Temperature range	10–40 °C (50–104 °F)
	Humidity	below 90 %, non-condensing
	Height above sea level	maximum 2000 m

Repeat Orders

Note For repeat orders of spare parts use the enclosed packing list. Contact the Technical Support in case there are any questions on spare parts or accessories.

Further information Find further information regarding spare parts and accessories at www.knauer.net.

Modules

Name	Order number
Pump P 6.1L isocratic with 10 ml stainless-steel pump head	APH30EA
Pump P 6.1L isocratic with 10 ml ceramic pump head	APH60EB
Pump P 6.1L isocratic with 50 ml stainless-steel pump head	APH30FA
Pump P 6.1L isocratic with 50 ml ceramic pump head	APH60FB
Pump P 6.1L binary with 5 ml stainless-steel pump head	APH35GA
Pump P 6.1L binary with 10 ml stainless-steel pump head	APH35EA
Pump P 6.1L binary with 10 ml ceramic pump head	APH65EB
Pump P 6.1L binary with 10 ml stainless-steel normal phase pump head	APH35ED
Pump P 6.1L quaternary with 5 ml stainless-steel pump head	APH34GA
Pump P 6.1L quaternary with 10 ml stainless-steel pump head	APH34EA
Pump P 6.1L quaternary with 10 ml ceramic pump head	APH64EB

Accessories and Spare Parts

	Name	Order number
Pump head	Pump head, 5 ml, stainless steel	AHA60
	Pump head, 10 ml, stainless steel	AHB40
	Pump head, 10 ml, ceramic	AHB32
	Pump head, 10 ml for normal phase, stainless steel	AHB40BA
	Pump head, 50 ml, stainless steel	AHC20
	Pump head, 50 ml, ceramic	AHC22
Check valves	Check valve unit for AZURA 5, 10 ml pump head, ruby sapphire	G0924B
	Check valve unit for AZURA 5, 10 ml pump head, normal phase, spring-supported, ruby sapphire	G0563-5
	Check valve unit for AZURA 50 ml pump head, ruby sapphire	G0924C
Inline filter	Inline filter cartridge 10/50 ml, vol. 60 µl	G1451
	Inline filter cartridge 10/50 ml, vol. 20 µl	G1451A
	Inline filter cartridge 10 ml, vol. 60 µl, bio	G1452
	Inline filter cartridge 10/50 ml, vol. 20 µl, bio	G1452A
Mixer	AZURA mixer 50 µl	AZZ00MB
	AZURA mixer 100 µl	AZZ00MC
	AZURA mixer 200 µl	AZZ00MD
	AZURA mixer 250 µl, bio	AZZ10ME
Solvent tray	AZURA solvent tray E 2.1L	AZC00
Drainage system	Corrugated hose 16 cm, PE gray	A9846-1
	Corrugated hose 150 cm, PE gray	A9846-3
	Funnel	P6431
	Exhaust	P6432
Capillary guide	Capillary guide top	P6424
	Capillary guide side	P6425
Control Unit	Control Unit CU 2.1, incl. user manual	AZD00
Accessories kit	AZURA accessories kit	FZA02
	Accessories kit P 6.1L isocratic	FPH30
	Accessories kit P 6.1L quaternary	FPH34

		Name	Order number
Tool		Accessories kit P 6.1L binary	FPH35
		AZURA tool kit	A1033
		Capillary cleaning kit	A0137
		Metal capillary cutter	A0681
Product riser		AZURA product riser (28 mm)	A9860
Power cable		USA	M1651
		UK	M1278
		Switzerland	M1597
		Europe	M1642
Colored side panels¹		Side panel White Knight (white)	P6145
		Side panel Deep Sea (dark blue)	P6145A
		Side panel Sparkling Meadow (green)	P6145B
		Side panel Imperial Dignity (bordeaux)	P6145C
		Side panel Naked Sword (silver)	P6145D
		Side panel Melting Copper (copper)	P6145E
		Side panel Melting Copper (copper)	P6145E
User Manual		User manual pump P 6.1L	V6890
Qualification documents		Installation qualification DE	VIQP61L
		Operation qualification DE	VOQP61L

1. Please note that only KNAUER authorized personnel and companies may open the devices. To have to side panels exchanged, contact the Technical Support.

Disposal

Hand in old devices or disassembled old components at a certified waste facility, where they will be disposed of properly.

AVV Marking in Germany

According to the German "Abfallverzeichnisverordnung" (AVV) (January, 2001), old devices manufactured by KNAUER are marked as waste electrical and electronic equipment: 160214.

WEEE Registration

KNAUER as a company is registered by the WEEE number DE 34642789 in the German "Elektroaltgeräteregister" (EAR). The number belongs to category 8 and 9, which, among others, comprise laboratory equipment.

All distributors and importers are responsible for the disposal of old devices, as defined by the WEEE directive. End-users can send their old devices manufactured by KNAUER back to the distributor, the importer, or the company free of charge, but would be charged for the disposal.

Solvents and Other Operating Materials

All solvents and other operating materials must be collected separately and disposed of properly.

All wetted components of a device, e. g. flow cells of detectors or pump heads and pressure sensors for pumps, have to be flushed first with isopropanol and then with water before being maintained, disassembled or disposed.

Legal Information

Warranty Conditions

The factory warranty for the device is valid for 12 months after the date of dispatch. All warranty claims shall expire in the event that any unauthorized changes are made to the device.

During the warranty period, any components with material or design-related defects will be replaced or repaired by the manufacturer free of charge.

This warranty excludes the following:

- accidental or willful damage
- damage or errors caused by third parties that are not contractually related to the manufacturer at the time the damage occurs
- wear parts, fuses, glass parts, columns, light sources, cuvettes and other optical components
- damage caused by negligence or improper operation of the device and damage caused by clogged capillary
- packaging and transport damage

In the event of device malfunctions, directly contact the manufacturer.

KNAUER Wissenschaftliche Geräte GmbH
 Hegauer Weg 38
 14163 Berlin, Germany
 Phone:+49 30 809727-111
 Telefax:+49 30 8015010
 e-mail:info@knauer.net
 Internet:www.knauer.net

Transport Damage

The packaging of our devices provides the best possible protection against transport damage. Check the devices for signs of transport damage. In case you notice any damage, contact the Technical Support and the forwarder company within three workdays.

HPLC Glossary

In the following chapter you find abbreviations and terminology that is used in HPLC.

Term	Definition
Binary pump	Pump configured to generate a gradient from two solvents.
Capillary	Thin metal or PEEK pipe that connects the components and devices inside of an HPLC system.
Check valve	Valve unit built into the pump head which guides the flow of liquid from the inlet to the outlet.
Chromatogram	The record of a detector signal, depending on the flow volume of the mobile phase or time.
Column	The column is filled with a matrix which separates the single components of a substance spatially by interacting with an analyte transported with the solvent to different degrees.
Control Unit	Hand-held device with a touchscreen to drive single AZURA devices locally.
Dead volume	Volume of capillary and system components between mixer, injector and column as well as between column and detector.
Degasser	Degasser module for fluids
Detector	Device measuring the composition or the quantity of a substance.
Eluent	Flowing agent that transports the substances to be separated or isolated through the column (solvent, mobile phase)
Flangeless fitting	Fitting without a protruding edge, which can be fastened manually.
GLP	Quality assurance system for laboratories (Good Laboratory Practice)
Gradient	Time-dependent composition of solvent (mobile phase) on low-pressure or high-pressure side of system
Ground	Protective measure for electro-conductive housing parts
HPG pump	Pump configured to generate a gradient on the high-pressure side. Usually a binary pump with two separate pump units which each convey one solvent. The gradient is generated behind the pump.

Term	Definition
High-pressure side	Devices and capillary which are under high pressure in an HPLC system
HPLC	High-pressure liquid chromatography (HPLC). High-pressure liquid chromatography
Isocratic	Mode of sample separation where the composition of a solvent remains constant
LAN	Local area network (LAN). Network in which HPLC devices and a computer are connected, in order to control the devices.
LED	Light-emitting diode
Low-pressure side	Devices and capillary which are under high pressure in an HPLC system
LPG pump	Pump configured to generate a gradient on the low-pressure side. Only one pump unit is used which contains small doses of the different solvents. The solvents are mixed in small mixing cycles by a valve block which is connected upstream. The gradient is generated before the pump.
Mixer	Component for the homogeneous mixing of solvents for the generation of a gradient
Mobile Control	Mobile application to control and program the whole HPLC system via wireless LAN.
pH	Measure for the acidic or alkaline character of an aqueous solution.
Pressure sensor	Component for measuring the system pressure
Pump	Device which conveys solvents in controlled quantities into a system.
Quaternary pump	Pump configured to generate a gradient from four solvents.
Solvent	Flowing agent that transports the substances to be separated or isolated through the column (eluent, mobile phase)
<i>Solvent Selection valve</i>	Component of the pump that allows selecting from two different solvents for every solvent channel. With this mechanism the solvent can be changed without having to manually change the system.
Valve	Device for varying the solvent flow.

Declaration of Conformity

Producer KNAUER Wissenschaftliche Geräte GmbH
Hegauer Weg 38
14163 Berlin, Deutschland

Model/Type Reference Pump P 6.1L Product no. EPH30, EPH34, EPH35, EPH38,
EPH39, EPH60, EPH64, EPH65, EPH68, EPH69

The product complies with the following standards:

Machinery Machinery Directive 2006/42/EC

EMC EMC Directive 2004/108/EC
IEC 61000-3-2:2012
IEC 61326-1:2011

Disposal RoHS Directive 2011/65/EU
WEEE Directive 2012/19/EU

Safety Low Voltage Directive 2006/95/EC
IEC 61010-1:2010
IEC 61010-2-081:2001 + A1
Canada: CSA C22.2 No. 61010-1 (3rd Edition, 2012)
USA: UL 61010-1 (3rd Edition, 2012)



The product was tested with a typical configuration. The mark of conformity has been applied to the rear panel.

Date Berlin, 24.04.2015



Alexandra Knauer (CEO and owner)

Index

Numerics

- 2-channel degasser 7
- 4-channel degasser 7, 23

A

- Accessories 11
- Acetonitrile
 - PEEK 18
- Additives 9
- Ambient conditions 16, 49
- Analog port 34
- AVV marking 72

B

- Binary pump 6, 7, 18, 20, 74
 - delay volume 57
 - mixing volume 57
- Bio-inert 6, 8, 9
- Biopurification 9

C

- Cap fitting 20, 21, 22, 23
- Capillary 17, 74
 - pre-installed 18
- Care 47
- Ceramic 6
- Check valve 51, 74
 - accessories and spare parts 61, 62, 63, 64, 65, 66, 67, 68, 69, 70, 71
 - clean 47, 52
 - install 52
 - remove 51
- Checking the fittings 47
- Chromatogram 74
- Chromatography software 9
- ClarityChrom® 9, 37, 47
- Cleaning 47
- Column 74
- Contact data 46
- Control 26, 37
 - chromatography software 37
 - Control Unit 26, 37
 - Mobile Control 37
- Control Unit 8, 9, 26, 37, 47, 74

D

- Dead volume 74
- decontamination 13
- Degasser 11, 22, 74

- Degasser module
 - technical data 59
- Degassing chamber 23
- Degree of protection 59
- Delay volume
 - binary 57
 - isocratic 56
 - quaternary 57
- Detector 74
- Device
 - care 47
 - connect to computer 27
- Dimensions 59

E

- Electrical connections
 - Events terminal strip 31
 - remote terminal strip 30
- Eluent 74

F

- Fitting
 - flangeless 18
- Fittings 17
- Flangeless fitting 18, 74
- Flow rate 58
- Flushing solution 11
- FPLC 9
- Functionality tests 38

G

- GLP 74
 - data 9
- Gradient 74
- Gradient formation
 - binary 56
 - quaternary 57
- Ground 74

H

- High-pressure side 75
- Hotline 15
- HPG pump 6, 74
- HPLC 9, 75

I

- Initial start-up 35
- Inline filter 46, 53
 - accessories and spare parts 61, 62, 63, 64, 65,

66, 67, 68, 69, 70, 71

- insert 54
- remove 53
- replace 53

IQ 38

Isocratic 75

- Isocratic pump 6
- delay volume 56

L

LAN 26, 27, 75

- port 29
- problems 39
- router 29
- settings 27
- setup 28
- troubleshooting 39

Leak

- remove 56

leak 12

Leak management

- connect 25

Leak sensor 56

LED 37, 75

Low-pressure side 75

LPG pump 6, 7, 18, 20, 22, 75

M

Maintenance

- maintenance contract 46
- maintenance intervals 47

Maximum pressure 58

Mixer 9, 46, 75

accessories and spare parts 61, 62, 63, 64, 65, 66, 67, 68, 69, 70, 71

- replace 55
- technical data 57

Mixing volume

- binary 57
- quaternary 57

Mobile Control 9, 37, 47, 75

Modifiers 9

O

OpenLAB® 9, 37, 47

Operating hours 47

OQ 38

P

Packing list 17

PEEK 10

- Acetonitrile 18

pH 75

Pin header 30

- wire 33

Piston backflushing 9, 11, 51

- flushing solution 11

Piston backflushing

- connect 24

PMax Mode 9

port (LAN) 29

power

- strip 13
- supply 13

Power consumption 16, 59

Power supply

- connect 34

power supply

- cable 13

Pressure sensor 6, 7, 48, 75

Problems and rectifications 40

professional group 11

Pump 75

- binary 6, 7, 18, 20

- de-aerate 35

- flush 48

- HPG 6

- integrate into a system 18

- isocratic 6, 19

- LPG 6, 7, 18, 20, 22

- put out of operation 48

- quaternary 6, 7, 22

- switch-on 36

Pump head 56

- accessories and spare parts 60

- connect to solvent 19, 21, 23

- dismount 50

- run-in 35

- storage 49

Pump head cooler 9

Q

Quaternary pump 6, 7, 22, 75

- delay volume 57

- mixing volume 57

- technical data 57

R

Repeat Orders 60

RFID 9

- chip 9

router (LAN) 29

S

safety equipment 12
Safety for users 11
Salts 9
Service 46
Service Interface 7
Setup 16
Software 9, 47
Solvent 9, 75
 change 48
 inlet 51
 line 51
solvent
 flammability 12
 line 12
 self-ignition point 13
 toxicity 13
 tray 12
Solvent bottles
 connect 17
Solvent conveyance 58
Solvent Selection valve 21, 75
 technical data 56
Spare parts 11
Stainless steel 9
Storage
 pump head 49
Switch-on 36
System Messages 41

T

Technical data
 binary pump 56
 degasser module 59
 delay volume 56, 57
 flow rate 58
 general 58
 gradient formation 56, 57
 isocratic pump 56
 maximum pressure 58
 mixer 57
 mixing volume 57
 quaternary pump 57
 solvent conveyance 58
 Solvent Selection valve 56
 weight 56
Technical Support, see Hotline 15, 46
test
 Installation Qualification 38
 Operation Qualification 38

Torque 47, 52, 54, 55
transport damage 73
Troubleshooting
 LAN 39

U

Unpacking 17

V

Valve 75
Valve block 24
Venting screw 6, 7, 48

W

Warning signs 14
warranty 73
Weight 56

© KNAUER Wissenschaftliche Geräte GmbH
All rights reserved.
The information in this document is subject to
change without prior notice. Translation of the
original German edition of this manual, version 1.2
2015-05-13
Printed in Germany on environmentally friendly
paper from sustainable forests.

® AZURA are registered trademarks of
KNAUER Wissenschaftliche Geräte GmbH

▶ See up-to-date manuals online:
www.knauer.net/downloads

www.knauer.net

HPLC · SMB · Osmometry

KNAUER
Wissenschaftliche Geräte GmbH
Hegauer Weg 38
14163 Berlin, Germany

Phone: +49 30 809727-0
Telefax: +49 30 8015010
E-Mail: info@knauer.net
Internet: www.knauer.net

