

TDTS 32

The analysis of sulfur compounds using on-line and off-line TD-GC(MS)

Summary

In this Application Note we show how Markes' TD technology is compatible with trace-level sulfur compounds, both in standard mixes and in real-life samples.

Introduction

Sulfur compounds are associated with unpleasant, pungent odours, which are noticeable even at low concentrations. These compounds are difficult to analyse as they are thermally labile (sensitive to high temperatures), particularly when in contact with metals. Moreover, several of the compounds of interest are very volatile, such as hydrogen sulfide and methanethiol.

The detection of sulfur compounds at trace levels is critically important in a number of air monitoring applications, including:

- Industrial emissions testing
- Environmental monitoring of off-odours, e.g. from sewage treatment plants and landfill sites
- Health and safety monitoring of toxic compounds, e.g. exposure to CS₂
- Flavour and fragrance testing
- Food studies, e.g. shelf life tests and off-odour profiling.

Thermal desorption (TD) is an ideal technique for the analysis of trace-level vapours. It provides both analyte concentration and efficient transfer/injection into the GC(MS) analytical system. Samples can be collected using sorbent tubes or canisters and analysed off-line by TD-GC(MS). Alternatively, air/gas samples can be drawn directly into the TD-GC(MS) system and analysed on-line.

1. On-line or canister analysis

On-line analysis is the method of choice for real-time monitoring of changes in the vapour concentration. On-line or canister sampling is also required when the compounds of interest are too volatile to be retained by sorbent tubes at ambient temperature, e.g. hydrogen sulfide.

The following on-line TD-GC method was developed¹ in response to the Korean off-odour regulations which came into force in February 2005. The regulations state maximum allowable concentrations for four sulfur compounds (Table 1).

Compound	Industrial area (ppb)	Other areas (ppb)
Hydrogen sulfide	60	20
Methanethiol	4	2
Dimethyl sulfide	50	10
Dimethyl disulfide	30	9

Table 1: Sulfur compound regulation limit levels (Korean off-odour regulations).

Analytical conditions

A Markes International UNITY™ Air Server™ system was connected to a GC fitted with a pulsed flame photometric detector (PFPD). For a schematic of the system setup, see Figure 1.

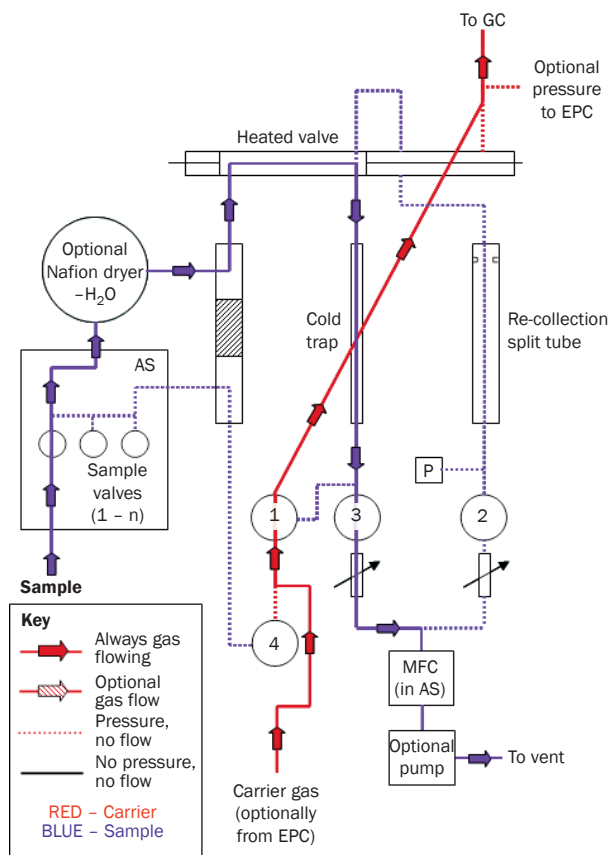

Figure 1: Schematic of UNITY Air Server setup.

TD (UNITY Air Server):

Sampling volume: 100–500 mL at 50 mL/min (critical)
 Nafion dryer: In-line
 Focusing trap: Graphitised carbon black/silica gel
 Trap low: -15 °C
 Trap high: 250 °C
 Hold: 5 min
 Flow path temp.: 80 °C (critical)

GC:

Column: VF-1 MS, 60 m × 0.32 mm × 5.0 µm
 Column flow: 2.0 mL/min
 GC oven: 60 °C (5 min), 8 °C/min to 200 °C

PFPD (square root function on):

Fuel gas: Air1: 17 mL/min, Air2: 10 mL/min, H₂: 14 mL/min
 Temp.: 200 °C (S filter)

Note that it is important to keep sampling flow rates above 50 mL/min and flow path temperatures below 100 °C in order to prevent degradation or loss of these labile analytes. It is also critical that the entire flow path is short, narrow-bore and is constructed entirely of inert materials (e.g. PTFE or quartz).

Calibration

Figure 2 shows the analysis of 10 ppb and 20 ppb gas standards, together with a typical QA/QC check-sample.

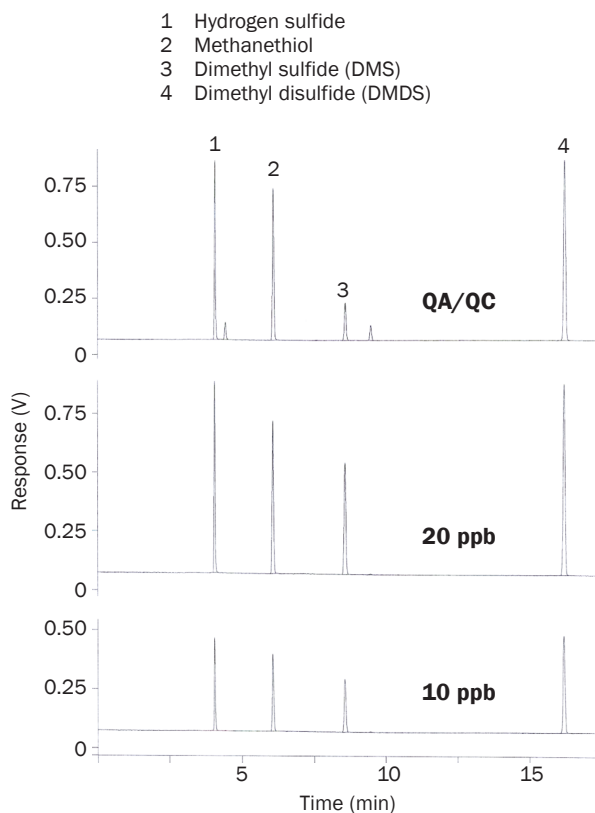

Figure 2: On-line chromatograms for 10 ppb and 20 ppb calibration standards and a QA/QC check-sample.

Detection limits²

Minimum achievable detection limits were 0.15 ppb for hydrogen sulfide, methanethiol and dimethyl sulfide, and 0.10 ppb for dimethyl disulfide. These limits were obtained with a sample volume of 200 mL and a split ratio of 4:1.

Linearity

The linearity of each compound was tested through the complete UNITY Air Server–GC analytical system (see Table 2). The sampled volume was 100 mL and the split ratio was ~13:1.

Compound	Peak area				Linearity (r)
	0 ppb	20 ppb	40 ppb	100 ppb	
Hydrogen sulfide	0	82438	218215	619303	0.9973
Methanethiol	0	176790	370921	949516	0.9983
Dimethyl sulfide	0	166279	345939	864878	0.9999
Dimethyl disulfide	0	318125	639442	1479555	0.9993

Table 2: Linearity data for the four sulfur compounds specified in the Korean off-odour regulations.

Reproducibility

Each of three concentrations of calibration gas were sampled ten times in order to obtain reproducibility data (see Table A1 in the Appendix). The sampled volume was 100 mL and the split ratio was ~13:1.

Excellent reproducibility was observed across all four compounds, and at all three concentration levels. For the 40 ppb and 100 ppb standards, RSDs below 1.8% were observed across all four compounds. This was maintained for the 20 ppb standard, except for hydrogen sulfide, which showed a slightly higher RSD of 4.1%.

Recovery³

Recovery was assessed at various relative humidities (using purified nitrogen) to investigate any bias in the method (Table 3). In each case results were compared to those from direct GC injection of the same mass of analyte under identical split conditions.

Compound	Relative humidity (%)	Recovery rate (average of three replicates) (%)
Hydrogen sulfide	0	103
	60	98
	80	93
Methanethiol	0	114
	60	113
	80	108
Dimethyl sulfide	0	110
	60	109
	80	107
Dimethyl disulfide	0	115
	60	114
	80	108

Table 3: TD recovery rate at various relative humidities.

Korean Odour Monitoring network data

The excellent analytical performance shown here during method development is reproduced in routine field operation.

A report⁴ presenting data from on-line odour monitoring systems (UNITY Air Server-GC) in operation in seven Korean cities shows:

- Peak area precision consistently below the guideline value of 10% RSD, with values for hydrogen sulfide between 0.5 and 4.3% across all laboratories.
- Stable retention times: <0.1% RSD for all compounds at all field monitoring sites.
- Excellent recovery across all analytes, with >87% recovery for the most volatile component (hydrogen sulfide) in all cases. This is well above the 80% performance criterion.

Discussion

The excellent system performance data – obtained in both laboratory trials and subsequent field operation – clearly show the inertness of the UNITY Air Server flow path.

This system has also been shown to be compatible with the most volatile sulfur compounds such as hydrogen sulfide, with no breakthrough during sampling or loss during analysis.

2. Off-line analysis with sorbent tubes

Off-line monitoring with sorbent tubes involves sampling air (either actively or passively) onto tubes packed with one or more sorbents that are suitable for trapping/retaining the volatility range of the compounds of interest. Due to the labile nature of sulfur compounds, a specially prepared inert-coated sorbent tube is recommended for this application. It is typically packed with two inert sorbents designed to retain sulfur compounds over a range of volatilities. (Note that hydrogen sulfide cannot be reliably sampled using sorbent tubes at ambient temperature).

The performance of the Markes thermal desorber and inert-coated sorbent tubes is illustrated both by the analysis of a standard sulfur calibration solution and by the analysis of landfill gas.

Analysis of the sulfur standard

The standard solution (1% in methanol) contained methanethiol, dimethyl sulfide, acetaldehyde, dimethyl disulfide and styrene. Three different sample volumes (0.5 µL, 1 µL and 2 µL) were injected onto a sorbent tube, in a flow of helium at 50 mL/min using Markes' Calibration Solution Loading Rig (CSLR™). The samples were then desorbed using the UNITY thermal desorber linked to GC/MS.

TD (UNITY):

Prepurge time: 0.5 min (split on and trap in line)
 Primary desorb: 200 °C for 3 mins (split on)
 Trap low: -10 °C
 Trap desorb: 200 °C for 3 min (split on)
 Trap: U-T6SUL (porous polymer/ carbonised molecular sieve)
 Flow path temp.: 80 °C

Carrier gas pressure: 10 psi
 Desorb flow: 3 mL/min
 Split flow: 45 mL/min
 Split ratio: ~400:1

GC:

Column flow: ~2 mL/min
 Start temp.: 60 °C for 0 min
 End temp.: 220 °C for 6 min
 Ramp rate: 10 °C/min
 Column: GS-Gaspro, 30 m × 0.32 mm

MS:

Source temp.: 230 °C
 Quadrupole temp.: 150 °C
 Transfer line temp.: 150 °C
 Mass scan range 25–350 amu

Figure 3 shows the chromatograms obtained from varying injection volumes of the standard solution.

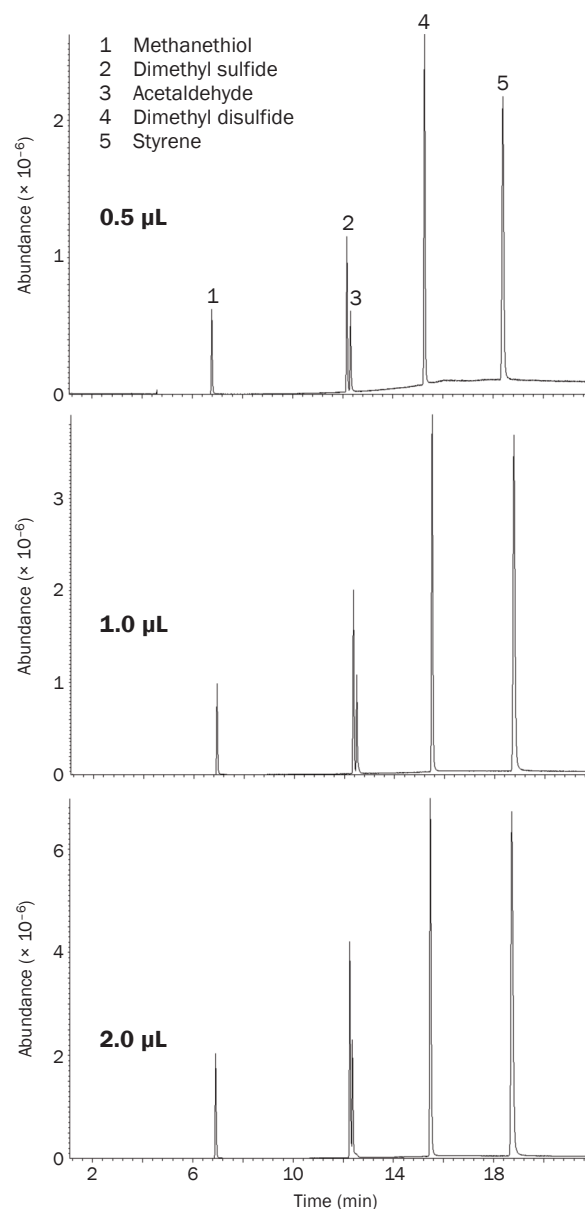

Figure 3: Injections of three different volumes of a standard solution.

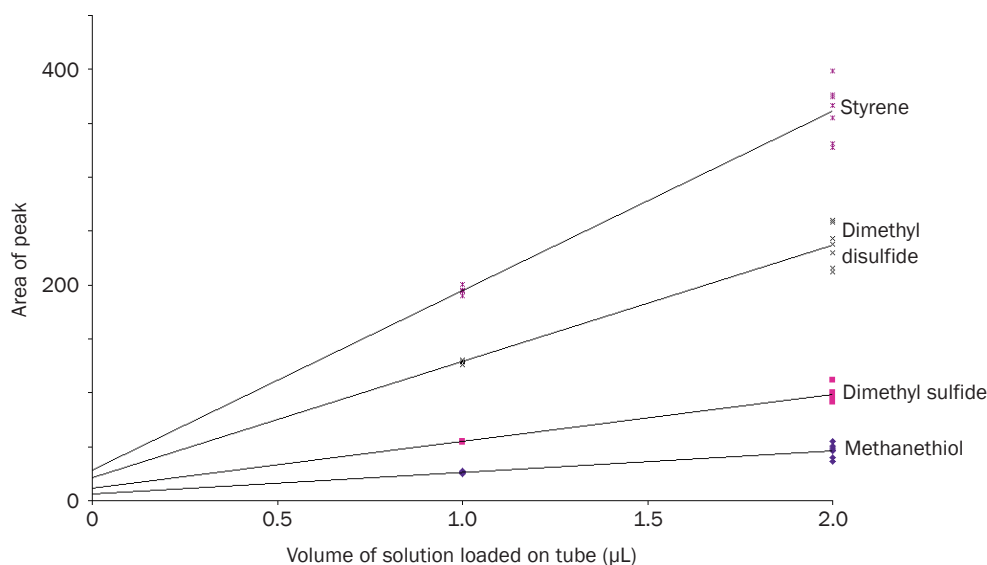

Figure 4: Peak area versus sample volume for each component in the sample mix.

Linearity

Linearity data are shown in Figure 4. The response for all four sulfur compounds was found to be linear.

Detection limits

Figure 5 shows the extracted-ion chromatogram from a 2 ng standard. This equates to approximately 2 ppb in 1 L of air. This approaches the minimum detection limit for methanethiol under these analytical conditions.

However, for dimethyl sulfide and dimethyl disulfide, the minimum detection limit is at least five times lower than this, i.e. 0.4 ppb in a 1 L air sample.

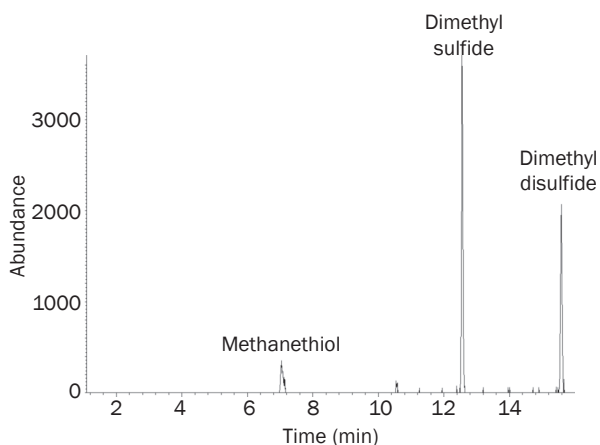

Figure 5: Extracted-ion chromatogram from a 2 ng standard solution – equivalent to approximately 2 ppb in 1 L of air.

3. Analysis of sulfur compounds in landfill gas

Levels of odorous and toxic vapours in landfill gas are controlled under European legislation on the landfill of waste (EC Directive - 1999/31/EC). This requires the concentration of priority pollutants in landfill gas emissions to be measured, and includes the following sulfur compounds:

- Methanethiol
- Ethanethiol
- Propanethiol
- Butanethiol
- Carbon disulfide
- Dimethyl sulfide
- Dimethyl disulfide

In the UK, a standard sampling and analytical protocol for compliance with the monitoring requirements of this directive is available⁵. It specifies active sampling of a small volume (~100 mL) of landfill gas onto inert-coated sorbent tubes followed by TD-GC/MS analysis. (Note that this method cannot be used for monitoring hydrogen sulfide).

The nature of landfill gas poses a number of problems when sampling onto sorbent tubes for TD-GC/MS analysis. These include humidity and reactivity.

Humidity

Landfill gas is usually at very high humidity and is often at elevated temperatures, which can complicate sampling and analytical procedures. It is essential to ensure that sorbent tubes are allowed to equilibrate to the same temperature as the landfill gas before sampling, and that all sampling lines are kept as short as possible.

If sampling of humid gas takes place onto tubes that are at a lower temperature than the gas, then condensation will occur and liquid water will collect in the sorbent tubes. This can lead to breakthrough during sampling and inefficient desorption during analysis.

Reactivity

The labile nature of the compounds of interest requires the use of inert sample tubes and sorbents (note that not all glass tubes are suitable for sulfur compound analysis). The sorbents used must also be compatible with analytes over a wide volatility range. A combination of Tenax TA (suitable for trapping the less volatile

compounds such as benzene) backed up by UniCarb™ (a carbonised molecular sieve sorbent, suitable for trapping volatiles such as methane thiol) packed in inert-coated stainless steel tubes was tested by the UK Environment Agency and found to work well. Both these sorbents are inert and have very low background artefact levels.

For further information on the analysis of landfill gas compounds, see Application Note TDTS 47.

Practical recommendations for landfill gas analysis

In order to minimise the amount of water vapour trapped on the tube and simplify sampling, samples are typically collected by pulling 100 mL of landfill gas through the tube using a large gas syringe. The tubes are then dry-purged prior to analysis. Dry-purging the sample tube simply involves passing a volume (typically ~400 mL) of pure, dry air or inert gas through the tube from the sampling end at a rate of ~50 mL/min. Care must be taken not to exceed the breakthrough volumes for any of the retained analytes during the dry purge process.

Due to the labile nature of the sulfur compounds and the nature of the two-bed sorbent tube (*i.e.* weak sorbent backed by extremely strong sorbent), it is essential to analyse the tubes as soon as possible after sampling and certainly within 4 days.

Analytical conditions

TD (UNITY):

Prepurge time: 1 min (split on) – trap in-line
 Primary desorb 1: 200 °C for 5 min (split on)
 Primary desorb 2: 300 °C for 5 min (split on)
 Trap low: 30 °C
 Trap desorb: 220 °C at 40 °C/s for 5 min (split on)
 Trap: U-T6SUL (porous polymer/ carbonised molecular sieve)
 Flow path temp.: 120 °C
 Carrier gas pressure: 25 psi
 Desorb flow: 20 mL/min
 Split flow: 80 mL/min
 Split ratio: ~100:1

GC:

Column flow: ~1 mL/min
 Start temp.: 40 °C
 End temp.: 225 °C
 Ramp rate: 10 °C/min
 Column: DBVRX, 60 m × 0.25 mm × 1.4 μm

MS:

Mode: Scan
 Mass range: 35–260 amu
 Threshold: 50
 Rate: 3.25 scans/s

Example chromatograms are shown in Figures 6 and 7.

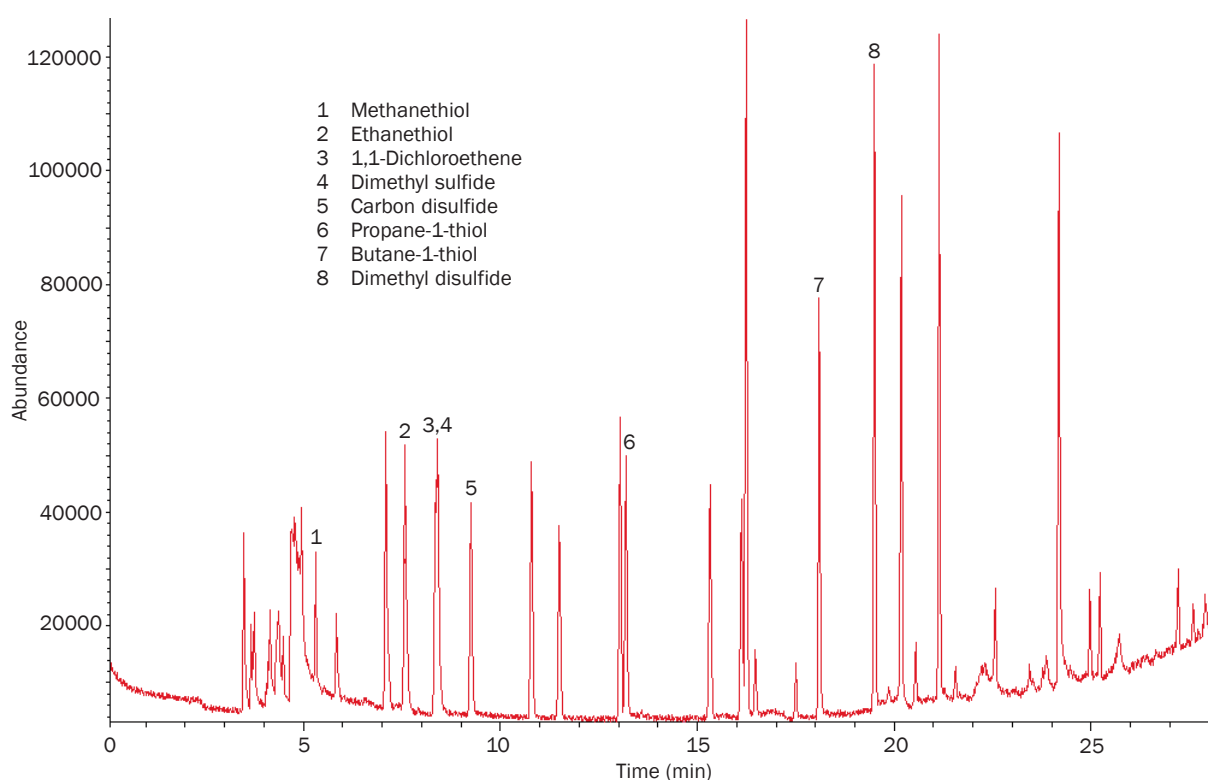

Figure 6: A 1 µL injection of a 50 ppm standard mix (~50 ng of each component), showing the seven key sulfur compounds on the landfill gas priority list.

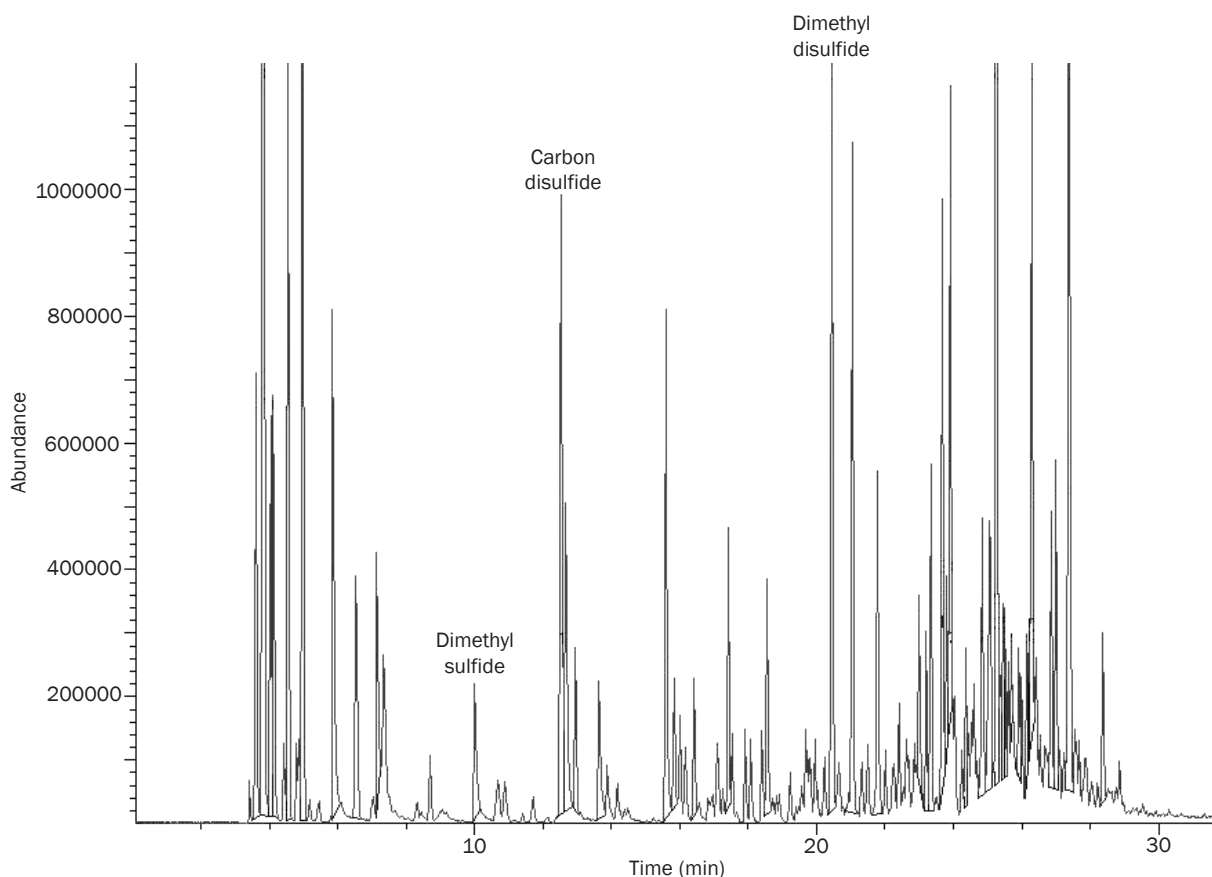

Figure 7: A 100 mL sample of landfill gas showing detection of trace levels of three key sulfur compounds.

Conclusions

Markes' TD technology has been shown to be compatible with on- and off-line monitoring of trace sulfur compounds in both standards and real-world samples. This is due to the following key features of the system:

- **Totally inert sample flow path** (i.e. constructed entirely of quartz, fused silica and inert-coated stainless steel). In some TD systems the heated valve connectors are metal, causing degradation of sulfur components and leading to the failure of this method.
- **Low-temperature valve and flowpath** (80–120 °C) Some TD systems have minimum flowpath temperatures of 150 °C, which is too high for monitoring reactive sulfur species.
- **Use of highly specialised focusing technology** for quantitative trapping and release of target sulfur compounds.

For off-line field monitoring of sulfur compounds using method-compliant sorbent tubes, it is also important for samples to be transferred to the laboratory as soon as possible and analysed within a few days.

Acknowledgements

Markes International gratefully acknowledge the contribution of both Professor Kim and ITC21 in the preparation of this Application Note.

References

1. Method developed by Professor K.-H. Kim of Sejong University, Seoul, South Korea (khkim@sejong.ac.kr) and ITC21, Sung Nam City, Korea (www.itc2000.co.kr).
2. K.-H. Kim, Some insights into the gas chromatographic determination of reduced sulfur compounds (RSCs) in air, *Environmental Science & Technology*, 2005, 39: 6765–6769.
3. K.-H. Kim, D.-W. Ju and S.-W. Joo, The evaluation of recovery rate associated with the use of thermal desorption systems for the analysis of atmospheric reduced sulfur compounds (RSC) using the GC/PFPD method, *Talanta*, 2005, 67: 955–959.
4. K.-P. Song *et al.*, A Study of quality assurance/quality control between institutions for reduced sulfur compounds in the ambient air using cryofocusing thermal desorber with GC/PFPD, *Korean Journal of Odour Research and Engineering*, 2007, 6: 33–39.
5. LFTGN 04: Guidance for monitoring trace components in landfill gas, UK Environment Agency.

Trademarks

Air Server™, CSLR™, UniCarb™ and UNITY™ are trademarks of Markes International Ltd, UK.

Applications were performed under the stated analytical conditions. Operation under different conditions, or with incompatible sample matrices, may impact the performance shown.

Appendix

20 ppb

Compound	Injection										Av.	SD	RSD (%)
	1	2	3	4	5	6	7	8	9	10			
Hydrogen sulfide	76460	79036	82056	80372	82262	83807	83113	85978	83025	88271	82438	3350	4.1
Methanethiol	178052	182005	180246	174585	174370	180054	175625	172700	176003	174257	176790	3113	1.8
Dimethyl sulfide	165430	165550	167582	166836	164237	167215	167313	167183	167147	164300	166279	1285	0.8
Dimethyl disulfide	322276	320646	321332	314792	319151	317320	315838	314978	318441	316475	318125	2680	0.8

40 ppb

Compound	Injection										Av.	SD	RSD (%)
	1	2	3	4	5	6	7	8	9	10			
Hydrogen sulfide	214768	214999	218966	219496	219740	217208	216217	222580	220169	218003	218215	2465	1.1
Methanethiol	375418	371806	370029	370483	374777	372415	370784	368924	367694	36680	370921	2786	0.8
Dimethyl sulfide	341996	337985	345363	345658	343218	348081	347328	351048	348833	349884	345939	3989	1.2
Dimethyl disulfide	642067	633164	637461	641081	644071	643528	644157	634946	641445	632500	639442	4542	0.7

100 ppb

Compound	Injection										Av.	SD	RSD (%)
	1	2	3	4	5	6	7	8	9	10			
Hydrogen sulfide	607029	602222	621621	614785	615481	621670	618770	627965	629519	633963	619303	9905	1.6
Methanethiol	950364	649117	953585	942689	944820	954597	942524	951135	956390	949935	949516	4840	0.5
Dimethyl sulfide	857252	852854	862116	862870	862856	872753	866397	869007	870955	871724	864878	6529	0.8
Dimethyl disulfide	1484243	1480388	1479072	1475582	1483793	1491751	1478730	1473567	1475154	1473266	1479555	5782	0.4

Table A1: Reproducibility data over 10 replicate injections.