



# **Agilent 218 Purification Solution**

## **System User Guide**



**Agilent Technologies**

# Notices

© Agilent Technologies, Inc. 2012, 2013

No part of this manual may be reproduced in any form or by any means (including electronic storage and retrieval or translation into a foreign language) without prior agreement and written consent from Agilent Technologies, Inc. as governed by United States and international copyright laws.

## Manual Part Number

G9300-90301

## Edition

03/2013

Printed in Germany

Agilent Technologies  
Hewlett-Packard-Strasse 8  
76337 Waldbronn

**This product may be used as a component of an in vitro diagnostic system if the system is registered with the appropriate authorities and complies with the relevant regulations. Otherwise, it is intended only for general laboratory use.**

## Warranty

**The material contained in this document is provided “as is,” and is subject to being changed, without notice, in future editions. Further, to the maximum extent permitted by applicable law, Agilent disclaims all warranties, either express or implied, with regard to this manual and any information contained herein, including but not limited to the implied warranties of merchantability and fitness for a particular purpose. Agilent shall not be liable for errors or for incidental or consequential damages in connection with the furnishing, use, or performance of this document or of any information contained herein. Should Agilent and the user have a separate written agreement with warranty terms covering the material in this document that conflict with these terms, the warranty terms in the separate agreement shall control.**

## Technology Licenses

The hardware and/or software described in this document are furnished under a license and may be used or copied only in accordance with the terms of such license.

## Restricted Rights Legend

If software is for use in the performance of a U.S. Government prime contract or subcontract, Software is delivered and licensed as “Commercial computer software” as defined in DFAR 252.227-7014 (June 1995), or as a “commercial item” as defined in FAR 2.101(a) or as “Restricted computer software” as defined in FAR 52.227-19 (June 1987) or any equivalent agency regulation or contract clause. Use, duplication or disclosure of Software is subject to Agilent Technologies’ standard commercial license terms, and non-DOD Departments and Agencies of the U.S. Government will

receive no greater than Restricted Rights as defined in FAR 52.227-19(c)(1-2) (June 1987). U.S. Government users will receive no greater than Limited Rights as defined in FAR 52.227-14 (June 1987) or DFAR 252.227-7015 (b)(2) (November 1995), as applicable in any technical data.

## Safety Notices

### CAUTION

A **CAUTION** notice denotes a hazard. It calls attention to an operating procedure, practice, or the like that, if not correctly performed or adhered to, could result in damage to the product or loss of important data. Do not proceed beyond a **CAUTION** notice until the indicated conditions are fully understood and met.

### WARNING

A **WARNING** notice denotes a hazard. It calls attention to an operating procedure, practice, or the like that, if not correctly performed or adhered to, could result in personal injury or death. Do not proceed beyond a **WARNING** notice until the indicated conditions are fully understood and met.

## In this book...

This manual provides setup information on following modules:

- Agilent 218 Solvent Delivery Module (G9300A/G9301A)
- Agilent 325 UV/VIS Dual WL Detector (G9309A)
- Agilent 410 Autosampler (G9331A/G9332A)
- Agilent 440 Fraction Collector (G9340A)

### **1 Introduction**

This chapter introduces to the Agilent 218 Purification Solution system and its components.

### **2 Site Requirements and Specifications**

This chapter provides information on site requirements and specifications of your system.

### **3 Installation**

This chapter gives information about the installation of your Agilent 218 Solvent Delivery Module, Agilent 325 UV/VIS Dual WL Detector, Agilent 410 Autosampler, and Agilent 440 Fraction Collector.

### **4 Using, Troubleshooting, Maintenance and Parts**

This chapter provides information on how to access further details on the system components.

### **5 Cables**

This chapter provides information on cables used with the instrument.

### **6 Appendix**

This chapter provides additional information on safety, legal and web.

# Contents

<b>1</b>	<b>Introduction</b>	<b>7</b>
	Introduction to the System	8
	Introduction to the Agilent 218 Solvent Delivery Module	9
	Introduction to the Agilent 325 UV/VIS Dual Wavelength Detector	11
	Introduction to the Agilent 410 Autosampler	12
	Introduction to the Agilent 440 Fraction Collector	15
<b>2</b>	<b>Site Requirements and Specifications</b>	<b>17</b>
	Site Requirements	18
	Specifications	21
<b>3</b>	<b>Installation</b>	<b>23</b>
	Delivery	26
	Damaged Packaging	28
	Check Delivery	29
	Unpacking and Inspection	32
	Optimizing the Stack Configuration	35
	Installing the Solvent Delivery Module	39
	Installing the Detector	71
	Installing the Autosampler	84
	Installing the Fraction Collector	95
	Installing the RS-422/485 Communication Kit	107
	Installing the Stream Splitter	109
	Setup Hardware	110
	Setup the Software	115
<b>4</b>	<b>Using, Troubleshooting, Maintenance and Parts</b>	<b>135</b>
	Using, Troubleshooting, Maintenance and Parts	136

**5 Cables 137**

- Cable Overview 138
- Cable Connections 139
- Analog Output 140
- Relay Output 141
- Desktop PC Communications 144
- Synchronization Signals 145

**6 Appendix 149**

- General Safety Information 150
- Solvent Miscibility 156
- Solvent Compressibility 157
- The Waste Electrical and Electronic Equipment Directive 159
- Batteries Information 160
- Radio Interference 161
- Electromagnetic Compatibility 162
- Agilent Technologies on Internet 164

## Contents



# 1 Introduction

Introduction to the System	8
Introduction to the Agilent 218 Solvent Delivery Module	9
Introduction to the Agilent 325 UV/VIS Dual Wavelength Detector	11
Introduction to the Agilent 410 Autosampler	12
Agilent 410 Autosampler (G9331A)	12
Agilent 410 Preparative Autosampler (G9332A)	14
Introduction to the Agilent 440 Fraction Collector	15

This chapter introduces to the Agilent 218 Purification Solution system and its components.



## Introduction to the System

A complete Agilent 218 Purification Solution system includes:

- Agilent 218 Solvent Delivery Module(s),
- Tubing,
- Mast kit,
- Agilent 325 UV/VIS Dual WL Detector,
- Agilent 410 Autosampler/Agilent 218 Solvent Delivery Module/Agilent SD-1 Isocratic Solvent Delivery Module (for sample injection), and
- Agilent 440 Fraction Collector

As an option the HPLC Control Software Agilent OpenLAB CDS ChemStation Edition is recommended.

The Agilent 218 Purification Solution allows to combine the modules listed above with the following Agilent 1200 Infinity Series modules:

- Diode Array Detector (G1315 C/D)
- Multiple Wavelength Detector (G1365 C/D)
- Variable Wavelength Detector (G1314 B/C/E/F)
- Preparative Autosampler (G2260A)
- Dual Loop Autosampler (G2258A)
- Fraction Collector (G1364B)
- Binary Pump (G4220B)
- Manual Injector (G1328C) (combined with one or two Agilent 218 Pumps)

### NOTE

The option to combine several modules requires the Agilent OpenLAB CDS ChemStation software as master controller. The 218 Solvent Delivery Module as master controller supports only the modules listed above.



## Introduction to the Agilent 218 Solvent Delivery Module

The Agilent 218 Solvent Delivery Module uses proven single-piston rapid-refill technology for economy, reliability, and virtually pulse-free operation. A range of interchangeable pump heads allows operation at flow rates from 10  $\mu\text{L}/\text{min}$  to 200  $\text{mL}/\text{min}$ . Biocompatible pump heads are available for those analysts requiring a completely inert flow path.

A single-channel analog-to-digital converter built in to each Agilent 218 Solvent Delivery Module can convert a detector signal to digital form and transmit the data to a computer system. Five programmable analog inputs and three programmable relay outputs are available to further automate the HPLC system. The Agilent 218 Solvent Delivery Module is easy to use and very flexible in operation. It can be used in several different modes of operation: as a standalone isocratic pump, as either a master pump or a slave pump in a high pressure gradient system, as a sample inject pump in a preparative system, or in a fully automated HPLC system controlled by an external computer. In each case, the Agilent 218 Solvent Delivery Module provides outstanding accuracy over its entire range of pressures, flow rates, and solvents.

The Agilent 218 Solvent Delivery Module operates very quietly because of minimal motor noise and resonance vibrations.

A complete Agilent 218 Solvent Delivery Module includes a drive module, a pump head, and a pressure module.

One of the Agilent 218 Solvent Delivery Modules in the HPLC system needs to have a pressure module installed in its compartment in the pump side panel. The pressure module dampens pulsations and supplies the current system pressure value to the drive module. Software in the drive module ensures that the system pressure is within pre-set maximum and minimum limits. Flow rates are automatically corrected for solvent-compression effects based on the system pressure value read from the pressure module and a compressibility factor entered by the user for each solvent.

The Agilent 218 Solvent Delivery Module operates with a variety of Agilent 218 Solvent Delivery Module heads to maintain specified performance over designated flow and pressure ranges. The easily replaceable pump heads are

self-contained units including a spring-loaded piston and check-valve cartridges. Pump heads are not included with individual drive modules.

A complete HPLC system can be controlled either by an Agilent 218 Solvent Delivery Module or via OpenLAB CDS ChemStation Edition (recommended). When the computer controls pumps, all pumps are slaves and programming is done on the computer.

On the pump rear panel there is a single RS-422 male connector. This connector is used for bidirectional signals to and from the controller, whether the controller is an external computer or another Agilent 218 Solvent Delivery Module. Internal software in the Agilent 218 Solvent Delivery Module determines whether the pump is a master controller or a slave pump.

The possible system configurations (depending on the type of pumps and controller being used) are the following:

- Isocratic system
- Gradient system with one Agilent 218 Solvent Delivery Module as the controller

When several pumps are connected together, the master Agilent 218 Solvent Delivery Module can control the other pumps in the liquid delivery system. A master Agilent 218 Solvent Delivery Module can control up to three other slave units: either three additional pumps in a quaternary system, or two additional elution pumps and one injection pump. The master Agilent 218 Solvent Delivery Module can control other modules in the system using outputs, and receive information through input contacts.

All pumps are controlled by applicable instrument control software on a PC. The sample inject pump is plumbed into the system with a tee. The column is plumbed after the tee. When such an injection occurs, the Thru Pump Injector automatically begins to ramp up to the correct flow rate, delivers the sample, and then ramps back down to ensure consistent flow rate at all times during the analysis. The Solvent Delivery Modules work with the Thru Pump Injector and lower their flow rate during the injection to maintain a constant overall solvent flow rate.

- Gradient system with HPLC control software as a controller

In this configuration all pumps are slaves and the computer is the system controller. The HPLC control software controls the pumps via the serial interface cable and other devices through contact closures on the Control/Interface module (CIM) built into the Agilent 218 Solvent Delivery Module.

# Introduction to the Agilent 325 UV/VIS Dual Wavelength Detector

The Agilent 325 UV/VIS Dual WL Detector is integrated into a Liquid Chromatography System. The detector is controlled remotely by OpenLAB through Ethernet communications. In this situation, all functions of the detector are controlled through the Workstation software.

The detector measures the sample absorbance at the user-selected wavelength. The absorbance is displayed. Wavelength absorbance parameters are time programmable.

Features of the Agilent 325 UV/VIS Dual WL Detector:

- Stackable module
- Interchangeable flowcells
- Simple lamp replacement
- Comfortable control (OpenLAB)
- Wide detection range (peaks up to 40 AU/cm with appropriate flowcell)

## Introduction to the Agilent 410 Autosampler

The Autosampler is available in two configurations as the *Standard* Autosampler (G9331A) and the Preparative Autosampler (G9332A).

### Agilent 410 Autosampler (G9331A)

The Agilent 410 Autosampler has been designed to meet the needs of the modern analytical laboratory. The autosampler has the following features:

- Column temperature control and sample cooling guaranteeing consistent results
- High resolution syringe control guaranteeing superior precision for injection and reagent addition
- Fast replacement of the injection valve

Loop injection with Pressure Assisted Sample Aspiration is a proven concept that combines high precision with simplicity and reliability.

Three injection modes can be selected:

- Full loop
- Partial loop filling
- $\mu\text{L}$  Pick-up

Maximum precision, maximum flexibility and zero sample loss can be achieved with these features.

#### Side-Port Needle

The strong side-port needle combines the optimum point style for septa piercing with a minimum risk of blockage by septum particles.

## Column Oven

A column oven is an integral part of the Agilent 410 Autosampler because constant column temperature is important for long term stability of a chromatographic separation and may be required for GLP compliance.

## Reagent Addition

Internal Standard addition, sample dilution or derivatization can be programmed in a very simple manner. A single-stage derivatization of a sample in a separate (destination) vial requires no more than 4 program lines. Multi-reagent addition is also possible, two large volume reagent vials are available on the sample tray.

## Service Autosampler

Low instrument down time is accomplished by a high Mean Time Between Failure and quick instrument service. Special attention has been paid to these aspects of the concept, as is illustrated by the injection valve. The Agilent 410 Autosampler will alert you when the lifetime of the seal is exceeded or if the switching torque becomes too high. This allows preventive maintenance before injection performance degrades. And if necessary, the entire injection valve can be replaced in seconds with the unique Quick-fit valve mounting mechanism.

## Agilent 410 Preparative Autosampler (G9332A)

By just choosing Prep mode in your system settings, you can use the Agilent 410 Autosampler to inject all of your sample into a Preparative LC system or in other areas where large injection volumes are required.

The combination of large sample vials (10 mL), a large sample volume needle and a 2.5 mL syringe enable you to inject large volumes very reproducibly with high speeds and only 45  $\mu$ L of sample loss. The installed large bore valve (0.75 mm) with 10 mL sample loop enables you to inject from microliters to milliliters with the same AutoSampler. Flow rates up to 200 mL per minute are possible when in the Prep mode.

**Table 1** Tubing of the Agilent 410 Autosampler prep option

Tubing	Material	Dimensions	Volume
LSV sample needle and tubing	Stainless Steel	70 mm x 0.81 mm o.d. x 0.51 mm i.d.	45 $\mu$ L
LSV sample needle to high-pressure valve	ETFE	155 mm x 1/16" o.d. x 0.50 mm i.d.	45 $\mu$ L
Buffer tubing from high-pressure valve to syringe valve	PTFE	2550 mm x 1/16" o.d. x 1 mm i.d.	2000 $\mu$ L

If the Prep option is factory installed the installation instructions can be skipped.

If the Prep option is bought as a kit, carry out the installation instructions, see [“Installing the Agilent 410 Autosampler Prep Option”](#) on page 94 for more information.

## Introduction to the Agilent 440 Fraction Collector

The Agilent 440 Fraction Collector is a random access, single probe fraction collector and can accommodate a variety of racks. It is designed to automate the sample collection process. This fraction collector is designed to meet the diverse requirements of high-throughput laboratories.

Three racks are included with the fraction collector and are made of polypropylene to resist most chemical spills. Up to three racks of many configurations can be placed on the fraction collector. Additional sample racks can be set up in sequence and manually changed during an analysis as each rack's analysis is completed.

The rack closest to the rear of the fraction collector (next to the pillar) is considered rack number one.

# **1 Introduction**

## **Introduction to the Agilent 440 Fraction Collector**





## 2 Site Requirements and Specifications

Site Requirements 18

Specifications 21

This chapter provides information on site requirements and specifications of your system.



## Site Requirements

### Power Considerations

The instrument power supply has wide ranging capability. It accepts any line voltage in the range described in *Physical Specifications*.

#### WARNING

**Hazard of electrical shock or damage of your instrumentation can result, if the devices are connected to a line voltage higher than specified.**

→ Connect your instrument to the specified line voltage only.

---

#### CAUTION

Inaccessible power plug.

In case of emergency it must be possible to disconnect the instrument from the power line at any time.

→ Make sure the power connector of the instrument can be easily reached and unplugged.

→ Provide sufficient space behind the power socket of the instrument to unplug the cable.

---

## Power Cords

Different power cords are offered as options with the module. The female end of all power cords is identical. It plugs into the power-input socket at the rear. The male end of each power cord is different and designed to match the wall socket of a particular country or region.

### **WARNING**

#### **Absence of ground connection or use of unspecified power cord**

**The absence of ground connection or the use of unspecified power cord can lead to electric shock or short circuit.**

- Never operate your instrumentation from a power outlet that has no ground connection.
  - Never use a power cord other than the Agilent Technologies power cord designed for your region.
- 

### **WARNING**

#### **Use of unsupplied cables**

**Using cables not supplied by Agilent Technologies can lead to damage of the electronic components or personal injury.**

- Never use cables other than the ones supplied by Agilent Technologies to ensure proper functionality and compliance with safety or EMC regulations.
- 

### **WARNING**

#### **Unintended use of supplied power cords**

**Using power cords for unintended purposes can lead to personal injury or damage of electronic equipment.**

- Never use the power cords that Agilent Technologies supplies with this instrument for any other equipment.
-

## Condensation

### CAUTION

Condensation within the module

Condensation will damage the system electronics.

- Do not store, ship or use your module under conditions where temperature fluctuations could cause condensation within the module.
  - If your module was shipped in cold weather, leave it in its box and allow it to warm slowly to room temperature to avoid condensation.
- 

## Area selected

### WARNING

**Explosion, damage and accuracy of the module**

- Select an area free from drafts, corrosive atmospheres, and vibration.
  - Select a dust-free, low-humidity environment.
  - Use air-conditioning for control of the environment.
- 

## Bench Space

Make sure that the bench is designed to bear the weight of all modules.

For details on the space needed around the individual modules, refer to the according manuals:

- Agilent 218 Solvent Delivery Module - User Manual (G9300-90001)
- Agilent 325 UV/VIS Dual Wavelength Detector - User Manual (G9309-90000)
- Agilent 410 Autosampler - User Manual (G9331-90000)
- Agilent 440 Fraction Collector - User Manual (G9340-90000)

## Specifications

For details on specifications of the individual modules, please refer to the *Agilent 1200 Infinity Series Specifications Compendium*, or to the corresponding User Manuals.

## **2 Site Requirements and Specifications**

### **Specifications**



## 3 Installation

Delivery	26
Components of a Complete System	26
Damaged Packaging	28
Check Delivery	29
Delivery Checklists	29
Unpacking and Inspection	32
Optimizing the Stack Configuration	35
Isocratic System	36
Binary System	37
Auto-Preparative System	38
Installing the Solvent Delivery Module	39
Electrical Setup	39
Pump Head Installation	41
Pressure Module Installation	43
Internal Mixer Installation	45
Mast Kit and Components Installation	47
Installing the Mast	48
Installing the Manual Injection Valve and Bracket	49
Installing the Prime/Purge Valve and Bracket_system	51
Installing the 3-way Pump Head Prime Valve	52
Installing the Column Hanger	54
Plumbing Connections	55
Setting the Pump ID and Pump Head Size When Using HPLC Control Software	69
Setting the Pump ID and Pump Head Size When Using an Agilent 218 Pump as a Master Controller	70



Installing the Detector	71
Location of the Detector Module	71
Power Connection and Rear Panel Services	72
Avoiding Harmful interferences to Radio or Television Reception	74
Removing the Front Panel	75
Hydraulic Connections - Flowcells	76
Installing a Flowcell	77
Detector Outlet Back Pressure Restrictor	81
Installing the Door	82
Installing and Removing the Door	83
Installing the Autosampler	84
Location of the Autosampler Module	84
Overview of the Module	85
Installing the Sample Tray	88
Connecting the Waste Tubings	88
Starting the Autosampler	90
Rinsing the System with Wash Solvent	91
Connecting the HPLC to the Autosampler	92
Filling and Sealing the Vials	92
Loading the Sample Tray	93
Installing the Agilent 410 Autosampler Prep Option	94
Installing the Fraction Collector	95
Overview of the Module	95
Installation Overview	96
Assembling the Fraction Collector	96
Installing the Spill Tray	97
Installing the Rack Location Mat	98
Installing the Probe and Tubing	98
Assembling the Sample Racks	101
Installing the Sample Racks	102
Rack Orientation	103
Connecting the Power to the Fraction Collector	104
Connecting the Fraction Collector to the HPLC System	106
Determining the Delay Time	106
Determining the Correct Probe Depth	106



- Installing the RS-422/485 Communication Kit 107
- Installing the Stream Splitter 109
- Setup Hardware 110
  - Setup the Hardware 110
  - Setup the Pump 111
  - Setup the Autosampler 113
  - Setup the Detector 113
  - Setup the Fraction Collector 114
- Setup the Software 115
  - Install Agilent OpenLAB CDS ChemStation PrepLC Drivers 115
  - Setup the System with OpenLAB CDS ChemStation Edition - Control Panel 116
  - Setup Method 124
  - Setup the CIM in the OpenLAB CDS ChemStation PrepLC Drivers 130

This chapter gives information about the installation of your Agilent 218 Solvent Delivery Module, Agilent 325 UV/VIS Dual WL Detector, Agilent 410 Autosampler, and Agilent 440 Fraction Collector.

## Delivery

For detailed information on parts delivered with the modules, refer to the corresponding module manuals:

- Agilent 218 Solvent Delivery Module - User Manual (G9300-90001)
- Agilent 325 UV/VIS Dual Wavelength Detector - User Manual (G9309-90000)
- Agilent 410 Autosampler - User Manual (G9331-90000)
- Agilent 440 Fraction Collector - User Manual (G9340-90000)
- And to the User Manuals of the Agilent 1200 Infinity Series which allows combining with the modules listed above (see [“Introduction to the System”](#) on page 8)

## Components of a Complete System

A complete system comprises following modules (as ordered):

<b>Hardware Modules</b>	<b>p/n</b>	<b>Description</b>
	G9300A	Agilent 218 Isocratic Solvent Delivery Module
	G9301A	Agilent 218 Add-On Solvent Delivery Module (OPTIONAL)
	G9309A	Agilent 325 UV/VIS Dual WL Detector
	G9331A	Agilent 410 Autosampler
	G9332A	Agilent 410 Preparative Autosampler (OPTIONAL)
	G9340A	Agilent 440 Fraction Collector

**Software**

<b>p/n</b>	<b>Description</b>
M8366-64000	OpenLAB CDS Installation Driver Prep LC
M8367-64000	OpenLAB CDS Installation Upgrade Driver Prep LC
M8500AA	LC driver
M8301AA	OpenLAB CDS ChemStation Edition Workstation A.01.05 or higher

## Damaged Packaging

If the delivery packaging shows signs of external damage, please call your Agilent Technologies sales and service office immediately. Inform your service representative that the instrument may have been damaged during shipment.

### CAUTION

"Defective on arrival" problems

If there are signs of damage, please do not attempt to install the module. Inspection by Agilent is required to evaluate if the instrument is in good condition or damaged.

- Notify your Agilent sales and service office about the damage.
  - An Agilent service representative will inspect the instrument at your site and initiate appropriate actions.
-

# Check Delivery

## Delivery Checklists

### Delivery Checklist Pump

The pump is packed in a single carton.

The pressure module ordered with the pump is shipped separately and needs to be installed.

Any pump head ordered with the pump is packed separately.

The following list shows all items delivered in a standard delivery. Your personal list depends on your order, therefore countercheck delivery with your order.

- Agilent 218 Solvent Delivery Module
- Power cord
- Pump head kit
- Plumbing kit (G9300A)
- Pressure transducer module (G9300A)
- Mast kit (G9301A)
- Internal mixer (G9301A)

### Delivery Checklist Detector

The following list shows all items delivered in a standard delivery. Your personal list depends on your order, therefore countercheck delivery with your order.

- Agilent 325 UV/VIS Dual Wavelength detector
- Assy PWB Sync. Interface 325/335 (optional)
- Cross-over Ethernet cable
- Power cord

**NOTE**

Flow cells are required for the detector, but are ordered separately. See “[Hydraulic Connections - Flowcells](#)” on page 76 for suitable flowcells.

### **Delivery Checklist Autosampler**

The autosampler is packed in a single carton.

The following list shows all items delivered in a standard delivery. Your personal list depends on your order, therefore countercheck delivery with your order.

- Agilent 410 Autosampler (G9331A/G9332A)
- Power cord
- Agilent 410 Reservoir Rack
- Standard Tray Assy (G9332A)
- Agilent and PrepStar Mast kit
- Prime purge valve bracket
- Prime purge valve stainless steel

### **Delivery Checklist Fraction Collector**

The following list shows all items delivered in a standard delivery. Your personal list depends on your order, therefore countercheck delivery with your order.

- Agilent 440-LC Fraction Collector
- Assy USB RS-232 serial adaptor (optional)
- Rack
- Funnel Rack Kit (optional)
- Power cord

### **Delivery Checklist Capillary Kits**

Your order contains one of the following Capillary Kits:

- Binary Pump Stainless Steel Tubing Kit, 1/16 x 0.02 i.d.
- Binary Pump Stainless Steel Tubing Kit, 1/16 x 0.03 i.d.
- Binary Pump Stainless Steel Tubing Kit, 1/16 x 0.04 i.d.
- Binary Pump Stainless Steel Tubing Kit, 1/8 x 0.08 i.d.
- Isocratic Pump Stainless Steel Tubing Kit, 1/16 x 0.02 i.d.
- Isocratic Pump Stainless Steel Tubing Kit, 1/16 x 0.03 i.d.
- Isocratic Pump Stainless Steel Tubing Kit, 1/16 x 0.04 i.d.
- Isocratic Pump Stainless Steel Tubing Kit, 1/8 x 0.08 i.d.

In addition, a Technical Note with installation instructions is included.

### **Delivery Checklist User Documentation CD**

Part of a standard delivery is also the Agilent Purification & Preparative LC - User Documentation CD (G9300-64500).

## Unpacking and Inspection

### Unpacking and Inspection

- 1 Check carefully to make sure you received all the items listed on the packing list.
- 2 Carefully unpack all the containers and inspect the contents for damage as soon as possible.
- 3 Save the packing containers; they will be useful if you have to file a claim for damage, or in the case of future transit.

### Unpacking the Solvent Delivery System

#### **WARNING**

**Danger to hands and feet**

**The instrument is heavy.**

→ Always use a fork lift or other suitable lifting device when moving the instrument.

---

#### **CAUTION**

Overheating of the pump

Objects interfering with airflow to the pump

→ Maintain at least 15 cm (6 inches) clear space next to the fan.

---



## Unpacking the Detector

**Prerequisites** Ensure there is enough room on the bench for the detector.

### WARNING

#### Heavy weight

**The Agilent 325 UV/VIS Dual Wavelength Detector weighs in excess of 15 kg (33 lb).**

- Carry the instrument at least with 2 people.
  - Avoid back strain or injury by following all precautions for lifting heavy objects.
  - Ensure that the load is as close to your body as possible.
  - Ensure that you can cope with the weight of your load.
- 

- 1 Carefully unpack the unit from the shipping carton and place it on the bench.
- 2 Make sure to check carefully for all miscellaneous components that might be contained in the inner compartments.

### NOTE

The detector is a sensitive instrument and should always be handled with the degree of care appropriate for laboratory instrumentation.

---

### HINT

Keep the shipping carton, as it provides excellent protection if you have to transport or store the detector in the future.

---

## Unpacking the Autosampler

**CAUTION**

Risk of damaging the autosampler.

→ Do not lift the Agilent 410 Autosampler by the front cover.

- 1 Lift the Agilent 410 Autosampler as shown in [Figure 1](#) on page 34 with both hands under the instrument or with one hand under the front and the other hand grasping the rear top of the Agilent 410 Autosampler.

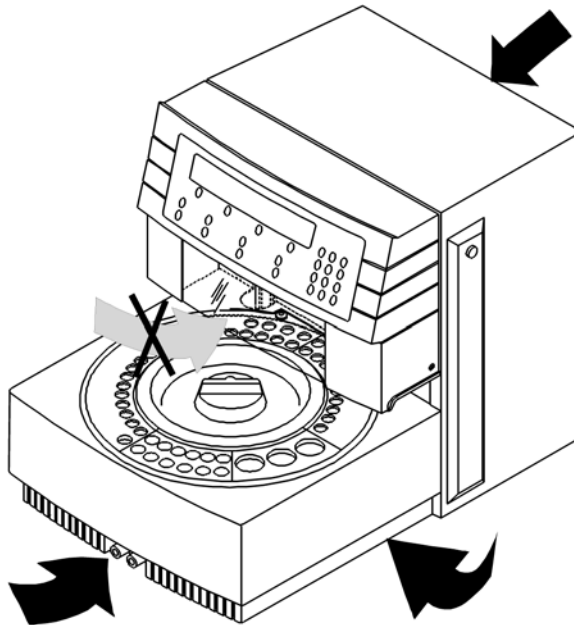

**Figure 1** Agilent 410 Autosampler lifting instructions

## Optimizing the Stack Configuration

This section contains information on how to stack your modules, depending on the preparative method.

For optimal performance in other configurations than in the given examples respect the following rules:

- The orientation is also suggested if you are only installing the Agilent 218 Pump.
- If an autosampler is present, it should be placed on top of the detector.
- Position the master pump as highest pump in the stack.

### NOTE

The pump with the pressure module is the master pump. In gradient systems, the remaining pumps are slave pumps.

---

This position allows easy access to keypad and display to control the HPLC-system via pump instead of software.

### 3 Installation

#### Optimizing the Stack Configuration

## Isocratic System

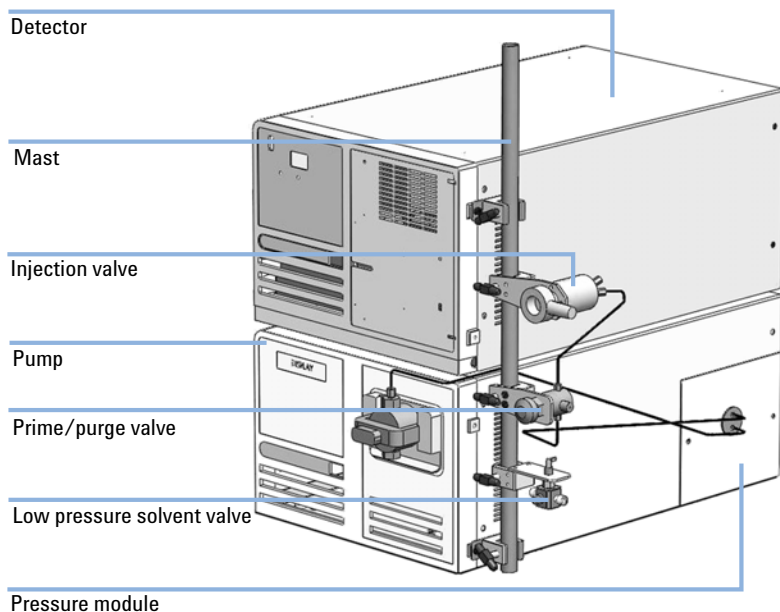
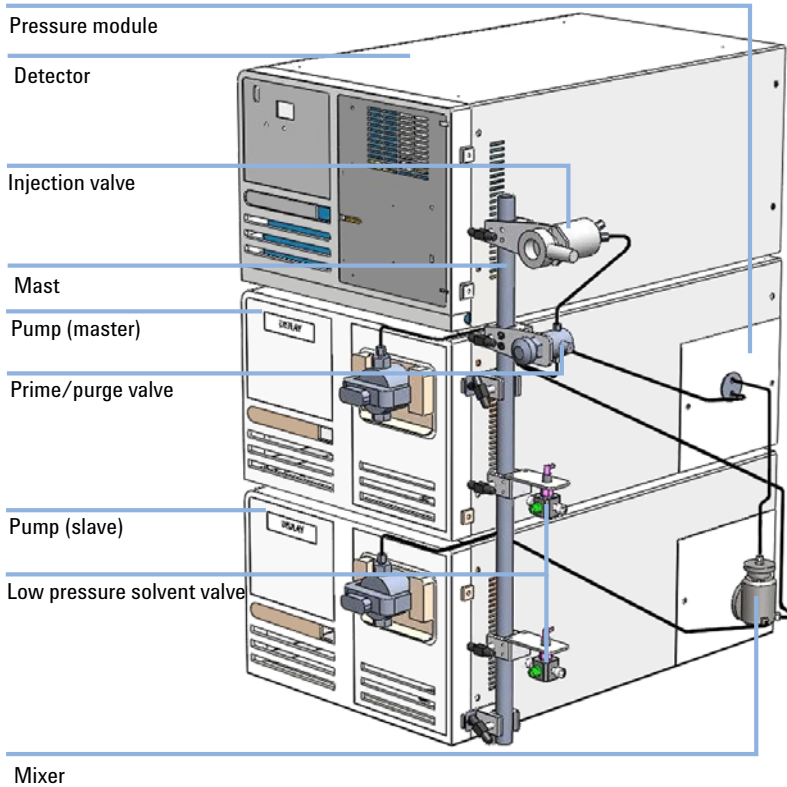

**Figure 2** Isocratic System

**Table 2** Isocratic system - component heights on the mast measured from the bench to the bottom of the bracket

Part	Height in mm (in.)
Injection valve	285 (11.2)
Prime/purge valve	185 (7.3)
Low pressure solvent valve	100 (3.9)

## Binary System



**Figure 3** Binary System

**Table 3** Binary system - component heights on the mast measured from the bench to the bottom of the bracket

Part	Height in mm (in.)
Injection valve	485 (19.1)
Prime/purge valve	385 (15.2)
Low pressure solvent valve	300 (11.8)
Low pressure solvent valve	100 (3.9)

### 3 Installation

#### Optimizing the Stack Configuration

## Auto-Preparative System

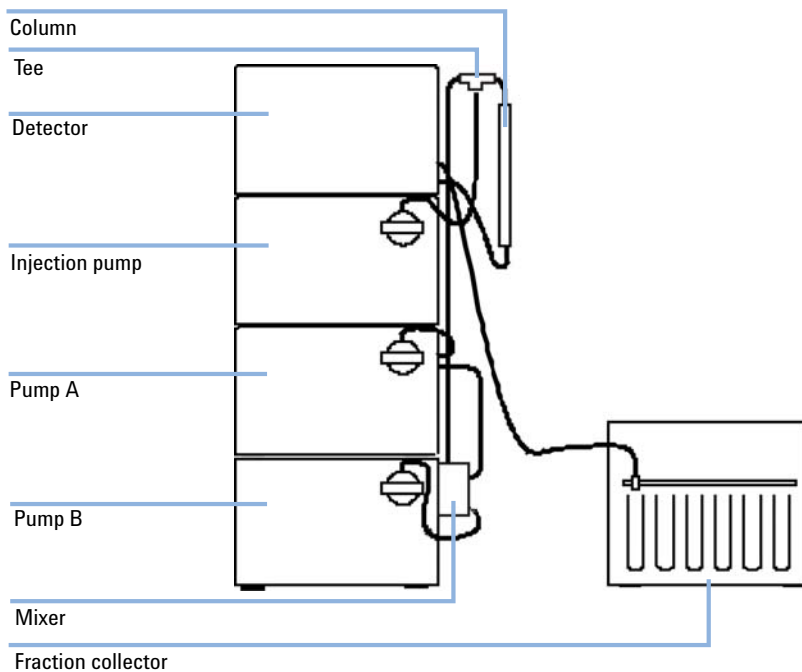

**Figure 4** Gradient Auto-Preparative System

#### NOTE

The injection pump is used for automatic injection.

#### NOTE

As all modules can be mixed, there is no general proposal for stacking. Depending on the modules that need to be installed there are two different ways of stacking. As described in the figure above the pump can be set at the bottom of a stack and the detector at the top. The other way is to build two stackings one with the pumps stacked on one stack, and a detector and sampler that are stacked on a second stack.

# Installing the Solvent Delivery Module

## Electrical Setup

### CAUTION

Damage to the module.

- Use only correct fuses, recommended for your voltage usage.
- A label stating the operating power rating of your instrument (as wired in the factory) is affixed to the rear panel adjacent to the power receptacle and voltage selection assembly (J1).
- The pumps are shipped with fuses installed; ready for operation on 220/230 V. You will need to reconfigure the voltage for 115 V usage.
- Check that the voltage configuration is set correctly for your local power requirements.
- If it is necessary to change the voltage configuration, see maintenance procedure in Agilent 218 Solvent Delivery Module - User Manual (G9300-90001).

- 
- 1 Setup electrical connections.
  - 2 Check that the ON/OFF power switch is off (in the O position).
  - 3 Connect the power cord to the back panel of the module and plug it into a grounded power socket.

### NOTE

A good ground connection is necessary to ensure safety for users and proper communications.

- 
- 4 Turn on the power switch.

### 3 Installation

#### Installing the Solvent Delivery Module

##### NOTE

If the pump does not start check following items:

- 1 Proper connection of the power cord
- 2 Power at the wall receptacle
- 3 Functionality of the main power fuse (F1)

For fuse installation, see maintenance procedure in Agilent 218 Solvent Delivery Module - User Manual (G9300-90001).

The fuse rating and operating voltage is printed on the rear panel next to the power receptacle.

---



## Pump Head Installation

The pumps are shipped without the pump head installed. You will have to install the pump head before beginning to run. You can also change pump heads at any time.

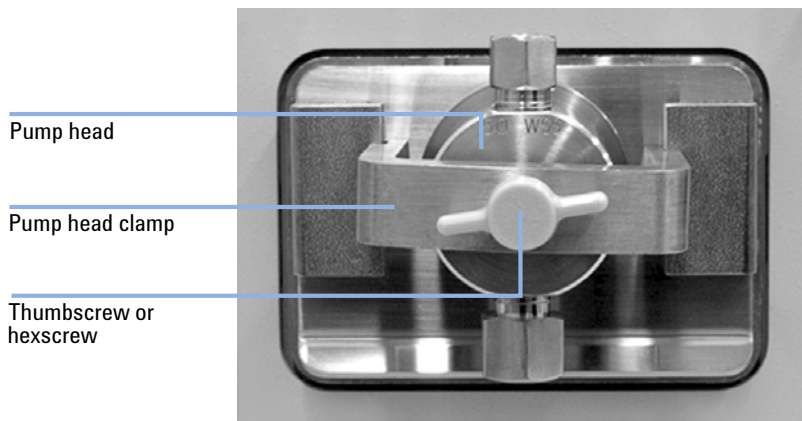

**Figure 5** Pump head installation

### Tools required

#### Description

Hex wrench, 1/4 in (200 mL/min head only)

- 1 Remove the shipping plug from the liquid head aperture on the front of the pump.
- 2 Insert the pump head into the front aperture of the pump.

### NOTE

The notch at the bottom of the pump head body must fit the matching pin on the pump, below the aperture. This notch ensures that the inlet and outlet ports are located in the correct position.

- 3 Holding the pump head in place, slide the clamp (found in the pump head kit) down over the head so the clamp flanges engage the slots on both sides of the pump head.

### 3 Installation

#### Installing the Solvent Delivery Module

##### NOTE

Depending on the position of the pump cam, you may have to push the pump head in to get the clamp on. Make sure that the clamp flanges are in their slots on both sides and finger-tighten the thumbscrew until the clamp holds the pump head securely.

In the case of the 200 mL/min head use the supplied hex wrench to tighten hex screw on the clamp. Tighten very securely. Repeat this procedure for each pump head in your system.

---

##### NOTE

There are three sizes of pump head clamps. The smaller one fits all pump heads that do not have piston wash. The larger one fits all heads that have piston wash. The largest clamp is used only with the 200 mL/min head.

---

- 4 Enter the pump head size into the pump software and into the pump firmware (from the key pad).

##### NOTE

For details see [“Setting the Pump ID and Pump Head Size When Using HPLC Control Software”](#) on page 69 or [“Setting the Pump ID and Pump Head Size When Using an Agilent 218 Pump as a Master Controller”](#) on page 70.

---

## Pressure Module Installation

Each Agilent 218 Pump can have a pressure module installed in the panel on the right side of the pump. The pressure module dampens pump pulsations and supplies the current pressure value to the Agilent 218 software. The pump needs this information to implement compressibility compensation and flow rate accuracy corrections and to ensure that system pressure is within the limits entered during setup.

Four pressure module ratings are available:

- 60.0 MPa (600 bar, 8700 psi),
- 41.4 MPa (414 bar, 6000 psi),
- 27.6 MPa (276 bar, 4000 psi),
- 13.8 MPa (138 bar, 2000 psi).
- 8.3 MPa (83 bar, 1200 psi).

These have different flow rate max/min (see Agilent 218 Solvent Delivery Module - User Manual (G9300-90001))

The pressure module is identified on the front of its panel. The connector from the pressure module should be plugged into the master pump. Only one pump in the HPLC system needs to have a pressure module installed.

<b>Tools required</b>	<b>Description</b>
	Phillips head screwdriver

### NOTE

You do not need to remove the top cover to install the pressure module or mixer. The covers are removed in some photographs for clarity.

### NOTE

If you are using an HPLC system with a Agilent 218 as controller, the pump with the pressure module should be the master controller (device ID = MC).

### NOTE

For the Agilent 1200 Infinity Series LC systems, the pressure module must go into the topmost pump.

### 3 Installation

#### Installing the Solvent Delivery Module

#### NOTE

If you are using a computer as controller, the pump with the pressure module needs to be identified in the controller configuration window.

- 1 Decide which pump is to have the pressure module installed, (i.e., which pump is the master pump) then remove the panel on the rear of the right side using a Phillips head screwdriver.



#### NOTE

Keep the panel in a safe place.

- 2 Place the pressure module in position and attach the connector to the plug on the inside of the pressure module compartment. The connection is done using a 9-pin 'D' shell connector. The 4-pin side of the connector is positioned towards the rear of the pump module. The module and its connector are a one-way fit.

Mixer connection with flat side toward rear of connector

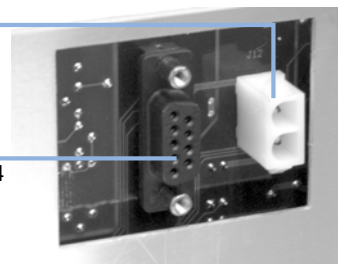

D-shell connector with 4 pin side toward back of module

Pressure module connector



#### Next Steps:

- 3 Tighten the screws on the mounting panel to hold the module in place.

#### NOTE

This is critical as the pressure module can slip out if the pump is picked up without the screws being tightened.

## Internal Mixer Installation

If two or more pumps are being used together to proportion individual solvents into one mixture, a mixer is required.

Mixers are available in several different materials and three different sizes:

- A 0.6 mL,
- 1.2 mL, and
- 10 mL mixer.

The internal mixer is identical in function and capability to the external mixer except that it obtains power from the pump drive module and it mounts into the pressure module bay at the right rear of the pump. The mixer is identified by a label on the inside of the mixer mounting panel. This identifies the mixer size, material and part number.

The mixer connects to the Agilent 218 Pump using a 2-pin Molex connector for power. There is no ON/OFF switch for the mixer. Whenever the Agilent 218 Pump is powered on, the mixer is running. This continuous running does not hurt the mixer. When no liquid is present, the mixing bars may not be moving. This is normal. When liquid is present, the mixing bars flip back and forth rapidly to mix the solvents.

**1** Ensure the pump power is turned off.

**2** Remove the cover panel from the right rear of the Agilent 218 Pump. Save the screws.



### 3 Installation

#### Installing the Solvent Delivery Module

- 3** Attach the 2-pin Molex connector to the white Molex connector in the mixer compartment. The flat sides of the connector should be toward the rear of the pump.

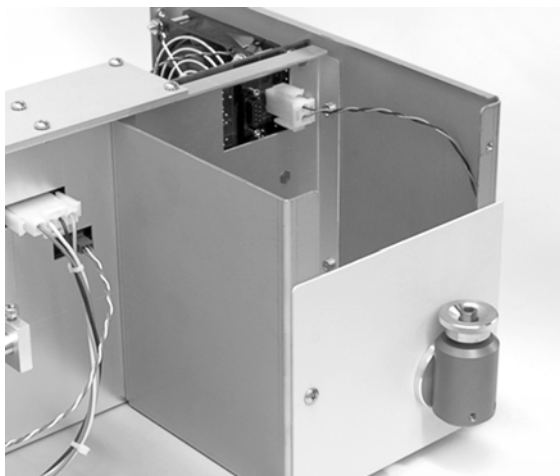
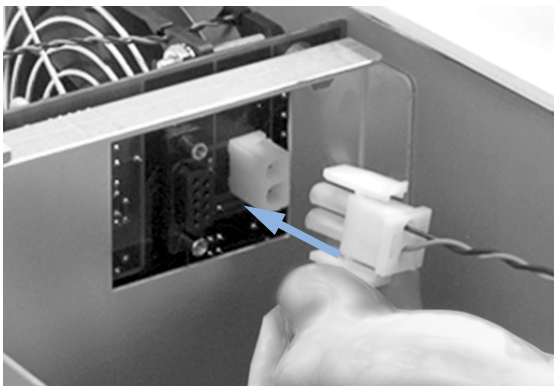

**Figure 6** Mixer internal connections

- 4** Fit the mixer panel onto the module and use the screws to fasten it to the pump.



## Mast Kit and Components Installation

- 1 “Installing the Mast” on page 48
- 2 “Installing the Manual Injection Valve and Bracket” on page 49
- 3 “Installing the Prime/Purge Valve and Bracket\_system” on page 51
- 4 “Installing the 3-way Pump Head Prime Valve” on page 52
- 5 “Installing the Column Hanger” on page 54

### 3 Installation

#### Installing the Solvent Delivery Module

## Installing the Mast

#### Parts required

#### Description

Mast kit (2x mast clamp bracket assembly, 2x 10-32 socket screws, stainless steel mast)

- 1 Remove the mast, brackets and two screws from the Mast Kit Assembly.
- 2 Attach a mast clamp to the fittings at the front corner of the pump.

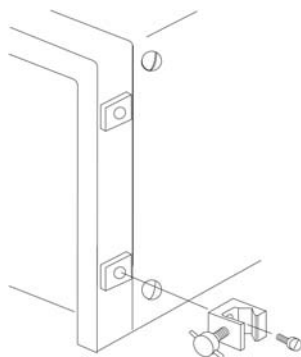

OR

Attach a mast clamp to the fittings one each on the lower front corner of the pump and top front corner of the detector (if fitted).



- 3 Secure the stainless-steel mast within the clamps so the lower end of the mast is level with the bench.



## Installing the Manual Injection Valve and Bracket

<b>Tools required</b>	<b>Description</b>
	Hex key, 2 mm, provided with the injection valve

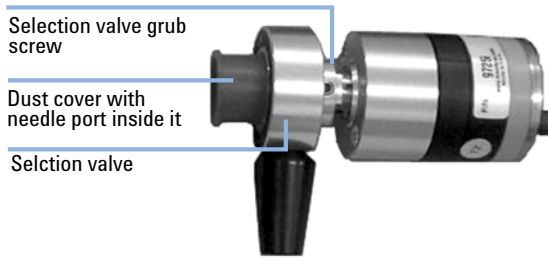
<b>Parts required</b>	<b>p/n</b>	<b>Description</b>
		Injection valve
	R000048605	Injection valve bracket

<p><b>1</b> Unpack the injection valve with attached black cable.</p>  <p>Selection valve grub screw Dust cover with needle port inside it Selection valve</p>	<p><b>2</b> Remove the red dust cover and gently pull out the needle port from the valve.</p>
<p><b>3</b> Remove the selection handle from the valve by loosening the two grub screws securing it to the injection valve body using the provided 2 mm hex key.</p>  <p>Flat side of metal post</p>	<p><b>4</b> Remove the two screws and injection valve bracket from the accessories bag that came with the injection valve.</p> <p><b>5</b> Attach the bracket to the injection valve with the two screws.</p>

### 3 Installation

#### Installing the Solvent Delivery Module

- 6** Replace the selection handle and tighten the two grub screws securing the handle using the 2 mm hex key. The grub screws should be flush with the flat side of the metal post.



Needle port

#### Next Steps:

- 7** Replace the needle port in the valve.
- 8** Attach the injection valve to the mast. For correct height see [“Isocratic System”](#) on page 36(isocratic system) or [“Binary System”](#) on page 37(binary system).

## Installing the Prime/Purge Valve and Bracket\_system

Parts required	#	p/n	Description
	1		Prime/purge valve - consult the documentation that came with the valve for the part number
	1	CP16267	Hex key, 2 mm
	1	R000048606	Prime/purge valve bracket for stainless steel purge valve
	1	R000048616	Prime/purge valve bracket for PEEK purge valve

### NOTE

While stainless steel images are shown here, the procedure is the same for PEEK or Titanium prime/purge valves.

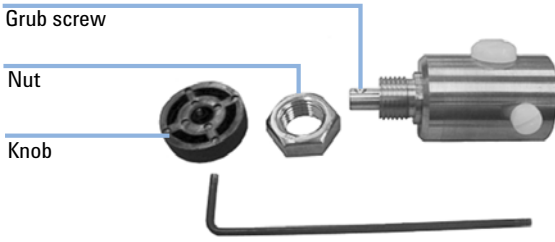
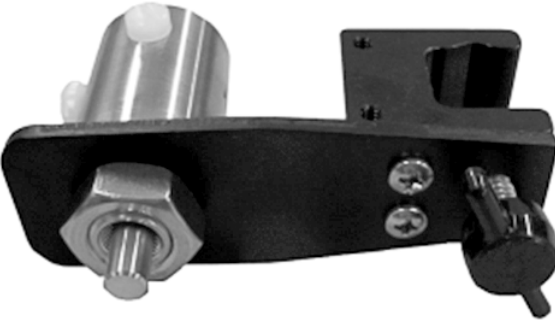
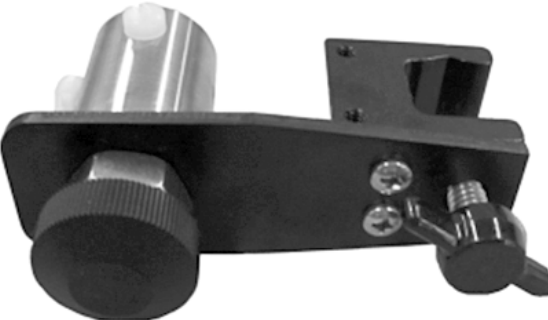
<p><b>1</b> Unpack the stainless steel purge valve and purge valve bracket.</p> 	<p><b>2</b> Remove the knob and nut from the purge valve. The knob is held in place with a grub screw which is loosened using a 2 mm hex key.</p> 
<p><b>3</b> Secure the valve to the valve bracket using the nut.</p> 	<p><b>4</b> Replace the knob on the valve and tighten the grub screw using the provided 2 mm hex key.</p> 
<p><b>5</b> Attach the purge valve to the mast. For correct height see “Isocratic System” on page 36 or “Binary System” on page 37.</p>	

### 3 Installation

#### Installing the Solvent Delivery Module

## Installing the 3-way Pump Head Prime Valve

<b>Tools required</b>	<b>Description</b> Hex key, 2 mm
<b>Parts required</b>	<b>Description</b> Pump head prime valve Pump head prime valve bracket

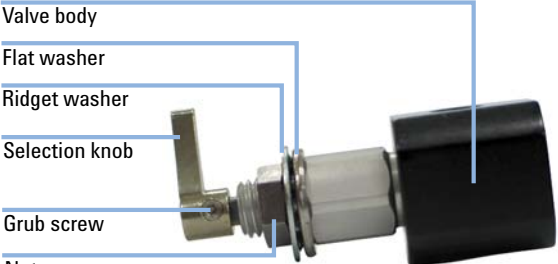
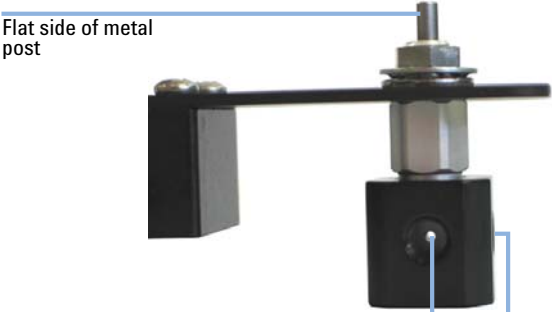
<p><b>1</b> Unpack the 3-way valve and bracket.</p> 	<p><b>2</b> Using the provided 2 mm hex key, loosen the grub screw and slide off the selection knob.</p>  <p>Valve body Flat washer Ridget washer Selection knob Grub screw Nut</p>
<p><b>3</b> Unscrew the nut and then remove the two washers from the 3-way valve.</p>	<p><b>4</b> Attach the bracket so that the three holes on the 3-way valve face away from the thumbscrew on the bracket.</p>  <p>Flat side of metal post Holes in 3-way valve body</p>

**CAUTION**

**Damage to the fittings**

→ **Finger-tighten the nut and use the provided hex key to tighten the selection knob.**

**5** Place the flat washer and then ridged washer on the 3-way valve. Screw on the nut to secure the two washers.

**6** Slide the selection knob onto the 3-way valve. The engraved lines on the top of the selection knob should point to the holes in the black body of the 3-way valve. The grub screw should be flush with the flat side of the metal post on the 3-way valve.



**Next Steps:**

**7** Secure the selection knob to the 3-way valve using only the provided 2 mm hex key. Do not over-tighten.

**8** Attach the 3-way valve to the mast. See [Table 2](#) on page 36 for the correct height.

**NOTE**

If you have a binary system, repeat this procedure for the second 3-way pump head prime valve. For correct height see [Table 3](#) on page 37.

### 3 Installation

#### Installing the Solvent Delivery Module

## Installing the Column Hanger

Parts required	#	p/n	Description
	1	R000048610	Analytical column hanger for ¼ in. OD
OR	1	R000048602	Preparative column hanger for 1 in. OD
OR	1	R000048601	Preparative column hanger for ½ in. OD

- 1 Attach the column hanger on to the mast so that the column inlet is close to the injection valve. Avoid blocking the other components.
- 2 Secure the column hanger by tightening the black thumbscrew on the bracket.



## Plumbing Connections

### CAUTION

Damage to the pump heads

- Each individual pump head has a different set of tubing that comes with the pump head for connection to the solvent reservoir and to the rest of the system. They also have individual nuts, bushings and ferrules that are used to connect the pump to the rest of the system. Use those parts to make the connections.
  - If you want to run the pump without liquid flow, remove the liquid head, or use demo mode.
-

### 3 Installation

#### Installing the Solvent Delivery Module

### Pump Head Low Pressure Tubing and Inlet Filter Assembly

The four types of inlet filter assemblies are shown below.

10 mL/min Heads



25-mL/min Head

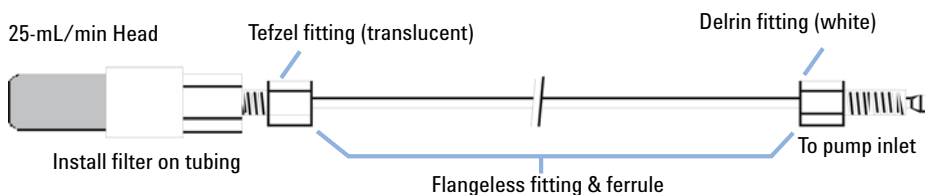

100 mL/min Heads

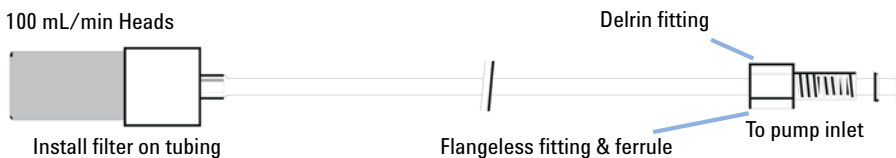

200 mL/min Head

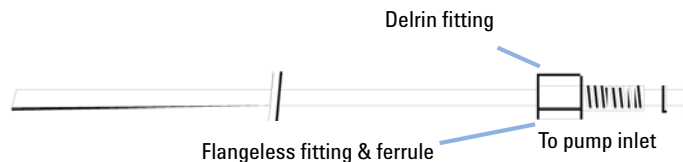

**Figure 7** Inlet filter assembly installation

#### Installation of inlet tubing for 10 to 100 mL/min heads

- 1 Remove the solvent inlet assembly from the accessories package and immerse the inlet filter into clean, HPLC-grade water.
- 2 Assemble the inlet filter onto the end of the inlet tubing.



- 3 Connect the inlet fitting to the inlet port on the pump head check valve (the lower port). Tighten the inlet tubing finger tight.

**NOTE**

If leakage occurs in use, tighten very slightly with an open-end wrench until the leak stops. Do not over-tighten. The fitting may be damaged.

---

**Installation of inlet tubing for 200 mL/min heads**

- 1 Remove the solvent inlet assembly from the accessory package and immerse diagonally cut end of tubing into solvent container. The solvent containers should be located on the floor with the pump on the bench.
- 2 Connect the inlet fitting to the inlet port on the pump head check valve (the lower port). Tighten the inlet tubing finger tight.

**NOTE**

If leakage occurs in use, tighten very slightly with an open-end wrench until the leak stops. Do not over-tighten. The fitting may be damaged.

---

**Installing the Piston-washing Tubing**

**NOTE**

Skip this step if you do not have piston washing on your pump heads. The wash tubing is provided as a single piece.

---

**NOTE**

When pumps are stacked, the tubing from the upper pump rinse outlet can be connected to the rinse inlet of the lower pump, so that pump heads can be rinsed in series. The tubing clamp need only be attached to the outlet rinse tubing on the bottom pump.

---

- 1 Cut into two pieces of appropriate length for the wash inlet and outlet.
- 2 Thread male Luer fittings into the inlet (top) and outlet rinse ports and connect the silicone tubing to the Luer fittings.
- 3 Attach the tubing clamp to the outlet tubing.

### Pump Head High Pressure Tubing

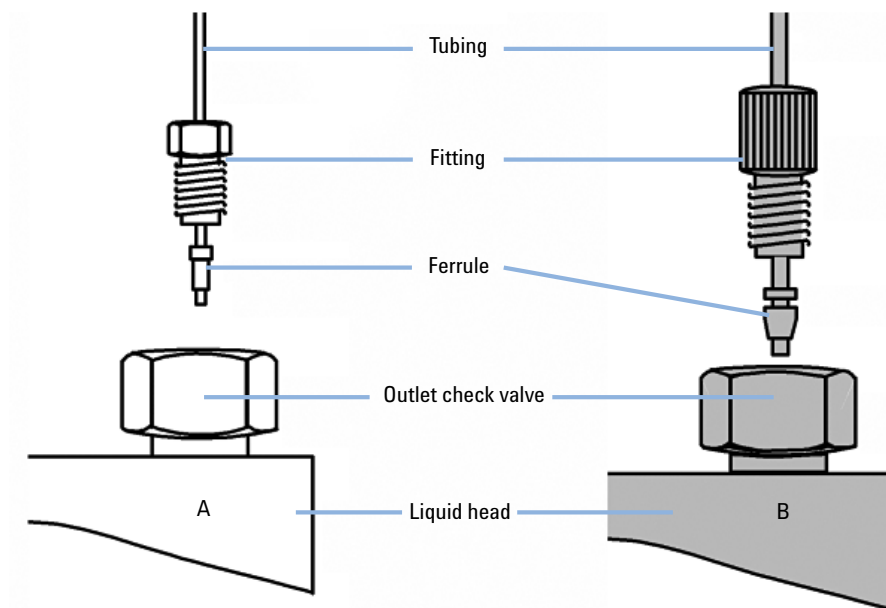

**Figure 8** High pressure tubing connections; A: titanium or stainless steel heads, B: PEEK Heads

#### Installation of high pressure tubing for titanium or stainless steel heads

- 1 Thread one of the  $\frac{1}{4}$ -28 male nuts and ferrules onto the outlet tubing. For orientation see (A).
- 2 With the nut and ferrule in place, insert the tubing into the outlet check valve as far as it will go.
- 3 Holding the tubing in place, tighten the nut  $\frac{1}{4}$  turn beyond finger-tight with an open-end wrench to swage the ferrule to the tubing.
- 4 Repeat this process at the other end of the outlet tubing for the next device in line (mixer, pressure monitor, etc.).

**NOTE**

If the connection leaks when the system is pressurized, tighten the nut slightly until the leak stops.

### Installation of high pressure tubing for high pressure tubing for PEEK heads

- 1 Thread one of the polyacetal nuts and ETFE (ethylene-tetrafluoroethylene) 2-piece ferrules onto the outlet tubing. For orientation see (B).
- 2 With the nut and ferrule in place, insert the tubing into the outlet check valve as far as it will go.
- 3 Holding the tubing in place, tighten the nut  $\frac{1}{4}$  turn beyond finger-tight with an open-end wrench to swage the ferrule to the tubing.
- 4 Repeat this process at the other end of the outlet tubing for the next device in line (mixer, pressure monitor, or drain valve).

#### NOTE

If the connection leaks when the system is pressurized, tighten the nut slightly until the leak stops.

### Connections for the outlet check valve

#### 200 mL/min Head

The 200 mL/min head uses 0.318 cm (1/8 in) tubing and fittings on its outlet. The pressure module used with the 200 mL/min head also uses 0.318 cm (1/8 in) tubing and fittings.

#### 100 mL/min Head

The pressure module comes with two 0.318 cm (1/8 in) to 0.159 cm (1/16 in) adapters for use with the 100 mL/min head. The outlet of the 100 mL/min head is 0.159 cm (1/16 in) tubing and fittings.

#### NOTE

Refer to [Figure 9](#) on page 62 for the appropriate outlet connections for your pump. The appropriate compression fitting is in the accessories package. Typically they are  $\frac{1}{4}$ -28 male nuts and ferrules.

### 3 Installation

#### Installing the Solvent Delivery Module

**Table 4** Connections for the outlet check valve

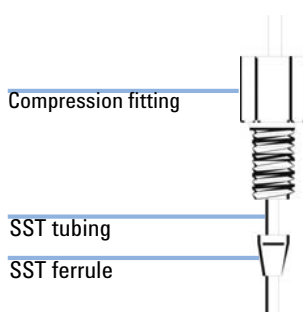
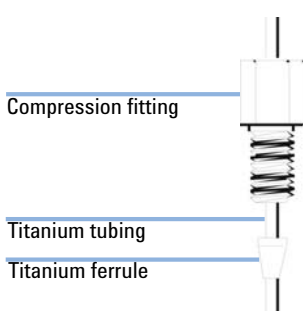
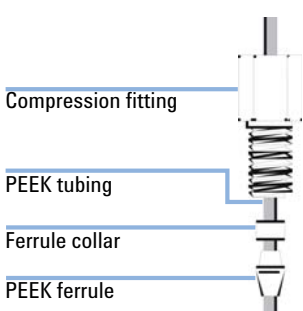
Outlet valve	Ferrule/Tubing (SST/SST)	Ferrule/Tubing (Titanium/Titanium)	Ferrule/Tubing (PEEK/PEEK)
<b>Analytical (SST)</b>	 <p>Compression fitting</p> <p>SST tubing</p> <p>SST ferrule</p>	 <p>Compression fitting</p> <p>Titanium tubing</p> <p>Titanium ferrule</p> <p>over 172 bar<sup>1</sup></p>	 <p>Compression fitting</p> <p>PEEK tubing</p> <p>Ferrule collar</p> <p>PEEK ferrule</p> <p>up to 172 bar</p>

**Table 4** Connections for the outlet check valve

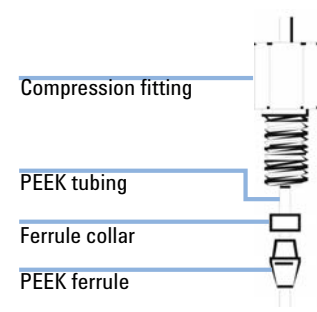
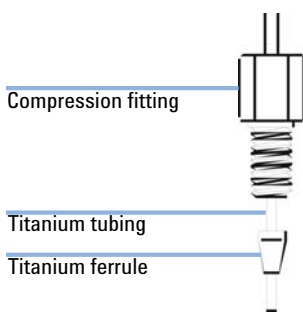
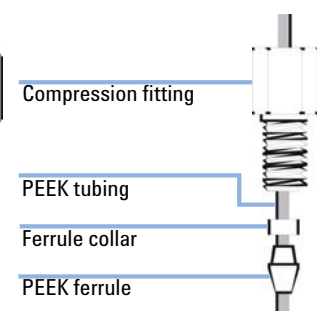
Outlet valve	Ferrule/Tubing (SST/SST)	Ferrule/Tubing (Titanium/Titanium)	Ferrule/Tubing (PEEK/PEEK)
<b>Semi-Prep (SST)</b>			 <p>Compression fitting</p> <p>PEEK tubing</p> <p>Ferrule collar</p> <p>PEEK ferrule</p> <p>over 172 bar 1/8 in tubing<sup>2</sup></p>
<b>Semi-Prep (Titanium)</b>	 <p>Compression fitting</p> <p>Titanium tubing</p> <p>Titanium ferrule</p> <p>over 172 bar</p>	 <p>Compression fitting</p> <p>PEEK tubing</p> <p>Ferrule collar</p> <p>PEEK ferrule</p> <p>up to 172 bar</p>	

<sup>1</sup> Unit conversion: 172 bar = 2500 psi = 17.2 MPa

<sup>2</sup> Unit conversion: 1/8 in = 0.318 mm

### 3 Installation

#### Installing the Solvent Delivery Module

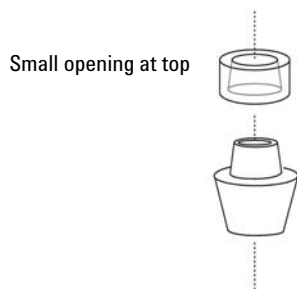

**Figure 9** Detail of PEEK ferrule and ferrule collar

## Narrowbore and Analytical Stainless Steel Mixers Plumbing Fittings

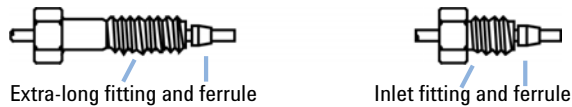

**Figure 10** Compression fittings for 0.6 mL (narrowbore) and 1.2 mL (analytical) stainless steel mixers

### Tools required

#### Description

Wrench, 1/4 in

- 1 For both the extra-long fitting on the outlet and the two standard fittings for the inlet, slide the fitting and ferrule over the 0.159 cm (1/16 in) OD tubing and push the end of the tubing into the port as far as possible.
- 2 Holding the tubing in place, finger-tighten the fitting, then tighten 1/4 turn more with a wrench. When tightening the outlet fitting, hold the top of the piston steady with another wrench.

### 3 Installation

#### Installing the Solvent Delivery Module

#### Analytical PEEK and Narrowbore/Analytical Titanium Mixers Plumbing Fittings



**Figure 11** Compression fittings for 1.2 mL (analytical) PEEK, and 0.6 mL (narrowbore) and 1.2 mL (analytical) titanium mixers

#### NOTE

Do not use tools to tighten.

- 1 Slide the 0.159 cm (1/16 in) OD outlet tubing through the one-piece fitting and ferrule and push the end of the tubing into the port as far as possible.
- 2 Holding the tubing in place, finger-tighten the fitting.
- 3 For both inlet ports, place a fitting and ferrule on the tubing and tighten in the same manner as the outlet fitting.



## Preparative PEEK/Titanium Mixers Plumbing Fittings

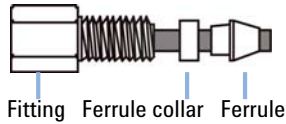

**Figure 12** Compression fittings for 10 mL (preparative) PEEK and titanium mixers

Tools required	Description
	Wrench, 5/16 in

### NOTE

All ports are identical.

- 1 Slide the fitting and ferrule/ferrule collar over the 0.318 mm (1/8 in) OD tubing as shown and push the end of the tubing into the port as far as possible.
- 2 Holding the tubing in place, finger-tighten the fitting. When tightening the outlet port fitting, hold the piston steady with another wrench (5/16 in).

### NOTE

When the system plumbing is complete, check for any leaks. If a leak is found, stop the pumps and tighten the affected fitting just enough to stop the leak.

## Connecting Communication Cabling Using Serial Interface

On the rear panel there is a single RS-422 male connector for serial communications.

Communications between slave pumps and controller (a computer or master pump) are established through the serial interface channel. This bi-directional communication protocol uses the EIA RS-422/RS-485 interface specification for data transmission.

Internal software in the pump determines whether the pump is a master controller or a slave pump. One software-controlled connector located on the back panel sends and receives signals from the controller (master pump or external computer). This connector is used on all pumps, both when the pump is used as a controller or as a slave: the software informs the controller of the status of each pump. The various configurations are discussed below.

### NOTE

Connection with a computer is covered in the interface manual of the specific software system used.

### Using OpenLAB as the System Controller

- 1 Cable your system, see [“Cable Connections”](#) on page 139.
- 2 Go to [“Setting the Pump ID and Pump Head Size When Using HPLC Control Software”](#) on page 69 or [“Setting the Pump ID and Pump Head Size When Using an Agilent 218 Pump as a Master Controller”](#) on page 70 to set the pump ID and pump head size.

### Using a Agilent 218 Pump as a System Controller

- 1 Enter the ID number of each Agilent 218 Pump using its own keypad.

### NOTE

Each pump in the system is connected with the serial interface cable. To distinguish one module from another, each module has a unique ID number. This number must be entered in each Agilent 218 Pump using its own keypad.

### NOTE

The ID number of the master pump is set by the user to **MC**. Slave pump ID numbers can be set as desired. Each system can have only one master pump. Slave pump IDs can also be set from a master pump from the **BUS IDs** menu.

### External Contacts Connectors

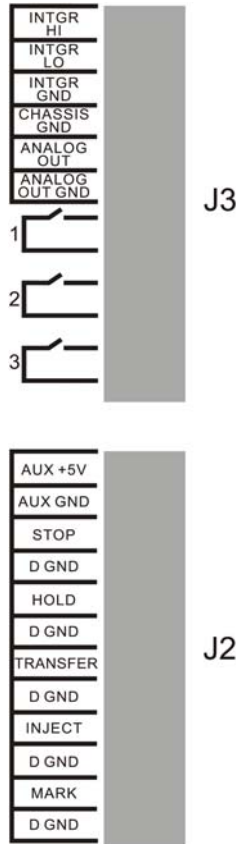

**Figure 13** External contacts connector

The Agilent 218 Pump has a number of analog and digital connections on the rear panel .

These can be used to digitize data from an analog detector, start and stop other devices through contact closures and to receive contact closures to start and stop the pump.

Connections are made to this strip by two connectors included in Standard accessory kit (393550991). These two connectors are then attached to another device.

### 3 Installation

#### Installing the Solvent Delivery Module

**Table 5** J3 terminal strip

Name	Connection
INTGR HI	Positive wire from detector
INTGR LO	Negative wire from detector
INTGR GND	Ground wire from detector <sup>1</sup> .
CHASSIS GND	Ground wire to chassis
ANALOG OUT	0 – 10 V output signal. Specifies which option to output as an analog signal to a recording device. Programmable options are: %A, %B, %C, %D (solvent composition %), pressure (system pressure), nm (wavelength specified in the I/O window), flow (system flow rate), or off. Full scale voltage is 10 V.
ANALOG OUT GND	Ground wire for Analog Out <sup>1</sup> .
1, 2, 3	Contact-closure relay outputs. These can be used to start external devices, such as an autosampler.

<sup>1</sup> Do not connect to Chassis Gnd

**Table 6** J2 terminal strip

Name	Connection
AUX +5V	5 V positive signal
AUX GND	Ground for auxiliary voltage <sup>1</sup> .
STOP	Contact closure input to stop the pump from an external device.
D GND	Digital ground for Stop signal <sup>1</sup> .
HOLD	Contact closure input from an external device to Hold a running method at the current time and flow/composition conditions.
D GND	Digital ground for Hold signal <sup>1</sup> .
TRANSFER	Contact closure input to Transfer to another method from an external device. Transfer can be immediate, deferred until the end of the current method pass, or automatic at the end of run if no contact closure is received.
D GND	Digital ground for Transfer signal <sup>1</sup> .

**Table 6** J2 terminal strip

Name	Connection
INJECT	Contact closure input from an external device which cancels a programmed Inject Wait or Hold.
D GND	Digital ground for Inject signal <sup>1</sup> .
MARK	Contact closure input to perform an Event Mark (a 10 % vertical trace on the chromatogram) from an external device.
D GND	Digital ground for Mark signal <sup>1</sup> .

<sup>1</sup> Do not connect to Chassis Gnd

### Installing the Capillary Kits

- 1 Install the Capillary Kit as described in the Technical Note of the Binary or Isocratic Pump Stainless Steel Tubing Kit.

## Setting the Pump ID and Pump Head Size When Using HPLC Control Software

This is done on the pumps whether you are using an HPLC control software or using one of the pumps as a master controller.

#### To set the pump ID when all pumps are slaves:

- 1 Turn the pump on.
- 2 Press **SETUP** and then press **ID**.
- 3 Set the ID for the Agilent 218 Pump either by entering a number between 0 and 63 , or pressing the **UP ARROW** or **DOWN ARROW** key to scroll through a preset list of choices. Available choices are: 0 – 63 , **MC** (master controller) or -- (no ID).

#### To set the pump head size when all pumps are slaves:

- 1 Turn the pump on.
- 2 Press **SETUP** and then press **HdSz**.

### 3 Installation

#### Installing the Solvent Delivery Module

- 3 Use the **UP ARROW** or **DOWN ARROW** key to select between a preset list of choices. Choices are: 5 , 10 , 25 , 50 , 100 , and 200 mL/min, 10P, 25P, 50P, 100P. The **P** designation stands for PEEK. The compressibility compensation for PEEK heads is different than for stainless steel or titanium heads.

## Setting the Pump ID and Pump Head Size When Using an Agilent 218 Pump as a Master Controller

### Setting the pump ID and pump head size

- 1 Turn the pump on.
- 2 Press **SETUP**.
- 3 Press **PUMP**.
- 4 Select between **A**, **B**, **C**, and **D**. Selecting a pump opens a window to set Pump ID, Head size, compressibility factors, and refill speed.

#### NOTE

For more information about setting the pump ID and pump head size, see **Setup** in Agilent 218 Solvent Delivery Module - User Manual (G9300-90001)

---

## Installing the Detector

### Location of the Detector Module

Place the detector conveniently near your HPLC system. The modular design of the detector enables you to locate it anywhere within the limitations imposed by the length of the power cord, fluid lines and signal cables. In order to keep liquid dead volume as low as possible and to minimize peak broadening in the lines, the distance between the column outlet and the flowcell inlet should be kept to a minimum.

For best performance, the detector should be located on a clean, sturdy, vibration free bench in an area free of:

- Heat sources (such as direct sunlight or a heater vent)
- Drafts (such as an open doorway, window, or air conditioner vent)
- Smoke or UV-absorbing vapor
- Corrosive or dusty atmosphere
- Potential liquid spills

Provide approximately 4 inches of space behind the unit so that the cooling fan intake is not impeded, and to allow easy access to the rear panel services (see [“Power Connection and Rear Panel Services”](#) on page 72).

## Power Connection and Rear Panel Services

**WARNING**

**Electrical shock**

**Risk of stroke and other personal injury.**

- Turn off the power to the detector before making power and signal cable connections.

The detector can communicate with other modules and devices in the entire HPLC system. All power and signal connections are made on the rear panel of the detector (see [Figure 14](#) on page 72). The connectors on the rear panel support communication configurations to a wide range of Agilent modules and non-Agilent devices.

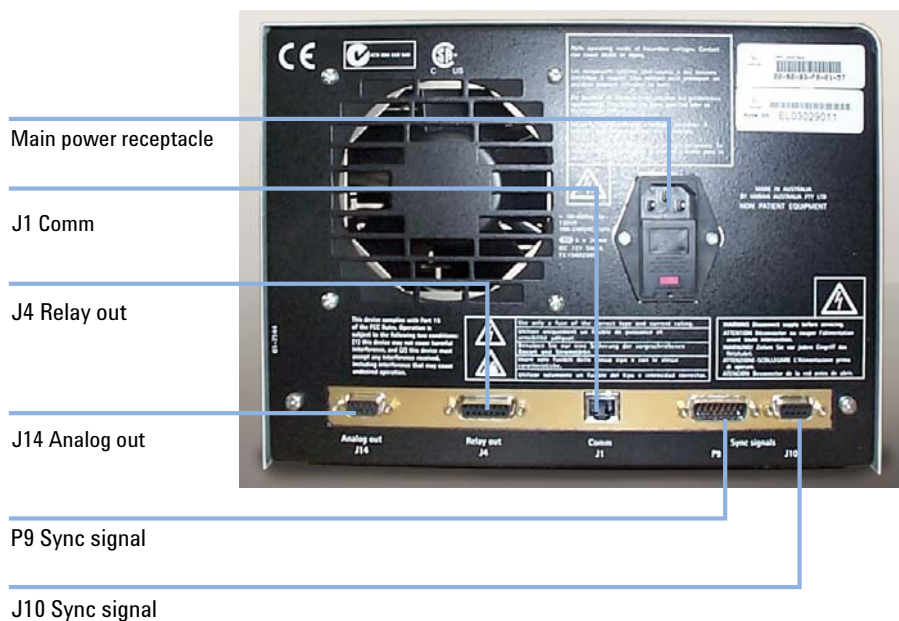

**Figure 14** Agilent 325 Detector rear panel services

The following table summarizes the function of each connection:



**Table 7** Rear panel services functions

Connection	Function
Main power receptacle	3-pin receptacle with 2 fuses
J14 Analog out	9-pin female "D" shell connector used for two channels (A and B) of analog output
J4 Relay out	15-pin female "D" shell connector used for time programmed contact closures
J1 Comm	RJ-45 type connector used to interface the Agilent 325 to a desktop PC
P9 Sync signal	15-pin male "D" shell connector used with synchronization signal cable
J10 Sync signal	9-pin female "D" shell connector used with synchronization signal cable

For more information about the connections see chapter Cables.

### AC Power

The Agilent 325 UV/VIS Dual Wavelength Detector may be connected to any voltage in the range 100 – 240 VAC  $\pm 10\%$ , 50 /60 Hz  $\pm 1$  Hz, single phase, without modification or the need to change fuses.

Before connecting power to the detector, ensure that the power switch on the front of the instrument is OFF (the rocker switch *O* is pressed). The power switch is a rocker switch that connects from the front of the detector directly to the power receptacle on the rear panel. Plug one end of the power cord into the power receptacle on the rear panel and the other end into your AC power source.

**WARNING**

**Absence of ground connection or use of unspecified power cord**

**The absence of ground connection or the use of unspecified power cord can lead to electric shock or short circuit.**

- Never operate your instrumentation from a power outlet that has no ground connection.
- Never use a power cord other than the Agilent Technologies power cord designed for your region.

---

All devices in the liquid chromatography system should be connected to the same power source, using a properly grounded (3rd wire to earth) multiple outlet power strip.

**NOTE**

Do not turn on the AC power yet. All required external devices and hydraulics must first be connected.

---

## Avoiding Harmful interferences to Radio or Television Reception

Operation is subject to the following two conditions:

- This device may not cause harmful interference.
- This device must accept any interference received, including interference that may cause undesired operation.

If this equipment does cause harmful interference to radio or television reception, which can be determined by turning the equipment off and on, the user is encouraged to try one or more of the following measures:

- 1 Relocate the radio or antenna.
- 2 Move the device away from the radio or television.
- 3 Plug the device into a different electrical outlet, so that the device and the radio or television are on separate electrical circuits.
- 4 Make sure that all peripheral devices are also certified.
- 5 Make sure that appropriate cables are used to connect the device to peripheral equipment.

- 6 Consult your equipment dealer, Agilent Technologies, or an experienced technician for assistance.
- 7 Changes or modifications not expressly approved by Agilent Technologies could void the user's authority to operate the equipment.

## Removing the Front Panel

- 1 If installed, remove the door from the Agilent 325 Detector (see [“Installing and Removing the Door”](#) on page 83 for more information).
- 2 Remove the panel on the front right side of the detector by unscrewing the captive screw in the top left corner of the panel.



**Figure 15** Removing the front panel

## Hydraulic Connections - Flowcells

Hydraulic connections are located at the front of the Agilent 325 Detector.

The only line installed by the user where dead volume and low holdup are critical is the line from the column exit to the flowcell inlet port. This line should be as short as possible.

The Agilent 325 Detector can be fitted with any one of four flowcells (ordered separately). Each one has an inlet and outlet connection and quartz optics cell window. Your chosen flowcell type is packed internally in the detector. The four flowcell types are outlined in [Table 8](#) on page 76.

**Table 8** Compatible flowcells

Flowcell type	Flowcell p/n	Pathlength <sup>1</sup>	Column ID	Flow rate	Maximum pressure
Analytical	210181800	9 mm x 0 mm	2 – 8 mm	0.0001 – 10 mL/min	69 bar (1000 psi)
Preparative <sup>2</sup>	210181900	9 mm x 1 mm	4 – 76 mm	1 – 500 mL/min	69 bar (1000 psi)
Scale Up <sup>2</sup>	210224200	4 mm x 0.25 mm	4 – 76 mm	10 – 200 mL/min	69 bar (1000 psi)
Super Prep <sup>2</sup>	210182000	4 mm x 0.15 mm	8 – 152 mm	30 – 1200 mL/min	69 bar (1000 psi)
Micro-analytical	210182100	4 mm x 0 mm	1 – 4 mm	0 – 20 mL/min	69 bar (1000 psi)

<sup>1</sup> A pathlength of a mm x b mm means that the sample light path has a pathlength of a mm, and the reference light path has a pathlength of b mm. A reference light path of zero means there is no fluid in the cell - air acts as the reference.

<sup>2</sup> Extended range cell

**NOTE**

It is important for the extended range cells to run at least at the minimum flow rate.

## Installing a Flowcell

The Agilent 325 UV/VIS Dual Wavelength Detector is not shipped with a flowcell installed. You will need to install the flowcell that you purchased with the detector. Each flowcell comes with a set of recommended nuts and ferrules that may be fitted to tubing.

1/16" tubing is used on all flowcells. However for the 4 mm x 0.15 mm super prep. flowcell it is recommended to use 1/8" tubing at higher flow rates. In this case you can add the Adaptor 1/8" - 1/16" (1610126800). This will require the 1/8" tubing and the 1/8" flowcell fittings.

Tubing connections are PEEK type, except for the Super Prep flowcell which uses ETFE tubing 0.125 mm x 0.062 mm.

Parts required	#	p/n	Description
	1	210181800	Flowcell 9 mm x 0 mm, inert (analytical)
OR	1	210181900	Flowcell 9 mm x 1 mm, inert (prep.)
OR	1	210224200	Flowcell 4 mm x 0.25 mm, inert (scale up)
OR	1	210182100	Flowcell 4 mm x 0 mm, inert (micro-analytical)
	1	9910128300	Flow cell replacement fittings
	1	210182000	Flowcell 4 mm x 0.15 mm, inert (super prep.)
	1	1610126900	Fitting 1/8" tube nut flat bottom
	1	1610126400	Fitting 1/8" tube ferrule, Pack of 10
	1	1610126800	Adaptor 1/8" - 1/16"

### 3 Installation

#### Installing the Detector

- 1 Fit the nuts and ferrules on the PEEK tubes.

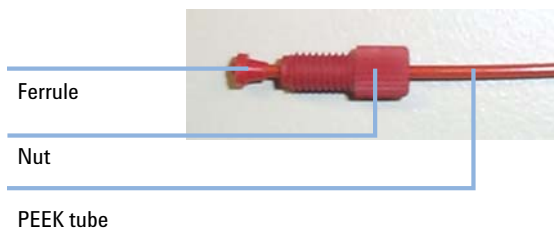

- 2 Screw the two tubes into the inlet and outlet connection of the flowcell. Each flowcell has an inlet and outlet connection.

#### NOTE

Be careful not to cross thread the connector into the flowcell body.

Do not over tighten, as this will damage the threads.

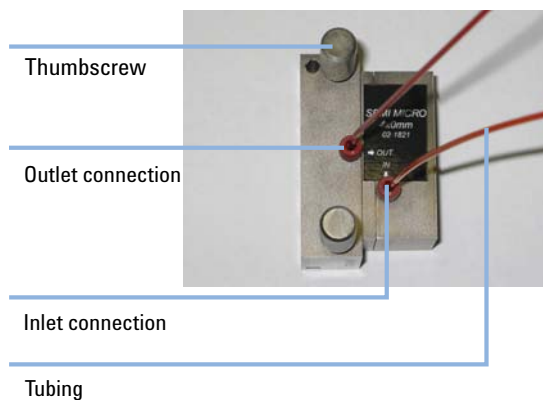

#### NOTE

The position of the inlet and outlet connections varies for different flowcells.

**3** Remove the front panel (see “Removing the Front Panel” on page 75 for more information).

**4** Carefully position the flowcell so that the two thumbscrews are positioned in the threaded holes in the flowcell compartment.

- a** Push at the center of the flowcell to ensure it is positioned squarely in its housing and that it is not tilted in any way.



**NOTE**

It is critical to the performance of the detector that the flowcell is inserted correctly. The internal optical components of the flowcell are an integral part of the detector's optical system. If the flowcell is not fitted correctly, it will have an adverse effect on detector performance.

### 3 Installation

#### Installing the Detector

##### Next Steps:

- 5 Secure the flowcell by tightening the thumbscrews with your fingers. Alternate tightening the thumbscrews until they are snug.
- 6 Replace the front panel.

##### NOTE

For optimum performance, the detector should be operated with the front panel in place. This is because the foam on the inside of the panel stops breezes, which may cause instability and noise, from reaching the flowcell.

##### NOTE

The flowcell should be removed with the connecting tubing fitted. These must be removed outside the detector compartment.

- 7 Perform a lamp calibration (see chapter maintenance in Agilent 325 UV/VIS Dual Wavelength Detector - User Manual (G9309-90000)).



## Detector Outlet Back Pressure Restrictor

The Back pressure restrictor (110743300) should be added to all flow cells, unless a fraction collector is installed after the detector. The back pressure restrictor assembly that was supplied with your detector should be threaded into the outlet line from the flowcell. The back pressure restrictor applies approximately 2.76 bar (40 psi) back pressure on the flowcell. This prevents outgassing and bubbles from forming or being trapped in the flowcell, which can cause an unstable baseline.

Note the arrow stamped on the restrictor body. This arrow must point away from the flowcell outlet port, and toward the waste receiver. The threaded plastic fittings should be finger tightened only enough to prevent leaks.

About 122 cm (48") of 1.6 mm (1/16") tubing is supplied at both the inlet and outlet of the restrictor. The inlet tubing is provided with a 1.6 mm (1/16") plastic tubing fitting for connecting to the flowcell outlet port. Either the outlet tubing can be directed to the waste container, or the tubing removed, and the restrictor itself dropped to the bottom of the waste bottle.

The restrictor pressure setting is not adjustable. If the restrictor fails or becomes plugged, replace the existing cartridge with a new 2.76 bar (40 psi) replacement.

## Installing the Door

The module door may be attached to the front of the Agilent 325 Detector to cover the tubing connections to the flowcell.

### NOTE

If the Agilent 325 Detector is the top module in the stack, the door cap should be installed before installing the door on the module.

### Installing the Door Cap

**If the Agilent 325 Detector is not at the top of the stack, do not install the cap and proceed to the instructions describing door installation.**

- 1 Stand the door upside down on a flat surface (i.e., with the two ribs towards the bottom).

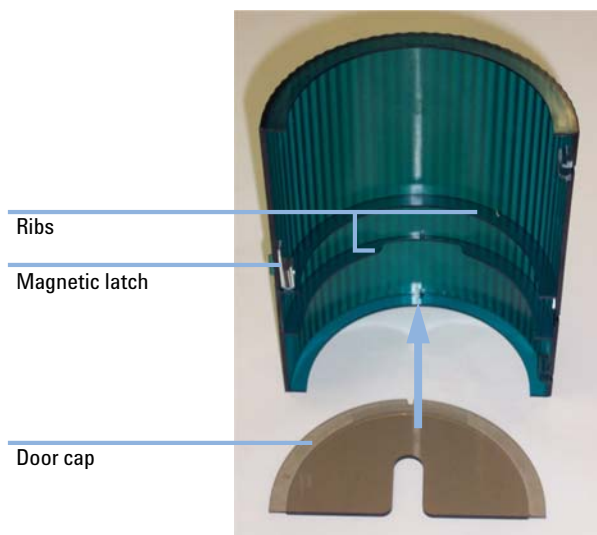
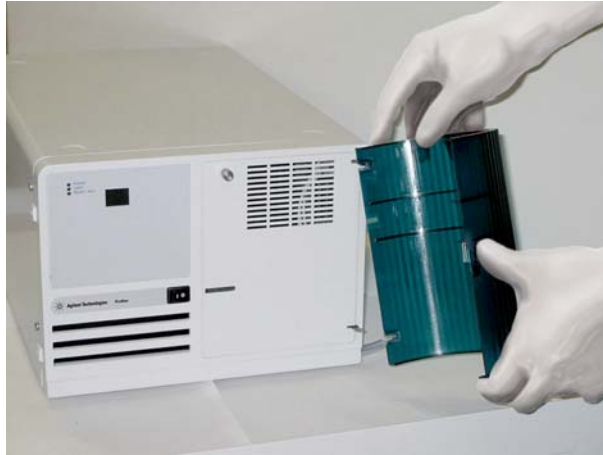

**Figure 16** Installing the door cap

- 2 Take the cap and remove the protective paper exposing the adhesive that will attach the cap to the door.
- 3 Insert the cap into the door and press the adhesive onto the inside of the door lip. Be sure to keep the door edges and cap edges flush.

### Installing the Door

- 1 Insert the top hinge pin into the top hinge.
- 2 Gently press down on the top of the door and slide the lower hinge pin into the lower hinge. The door should now pivot on the pins and close. The magnetic door latch should stick to the instrument.



**Figure 17** Installing the Agilent 325 Detector door

### Installing and Removing the Door

- 1 Gently push down on the door and slide the lower hinge pin out of the lower hinge.
- 2 Lift and slide out the top of the door.

## Installing the Autosampler

### Location of the Autosampler Module

The best place to install your Agilent 410 Autosampler is at the top of the module stack. This stack would normally be; solvent delivery module on the bench, detector on top of the SDM, and finally the AutoSampler. From the right-hand side you have the shortest connection to the injection valve of the Agilent 410 Autosampler to the column.

## Overview of the Module

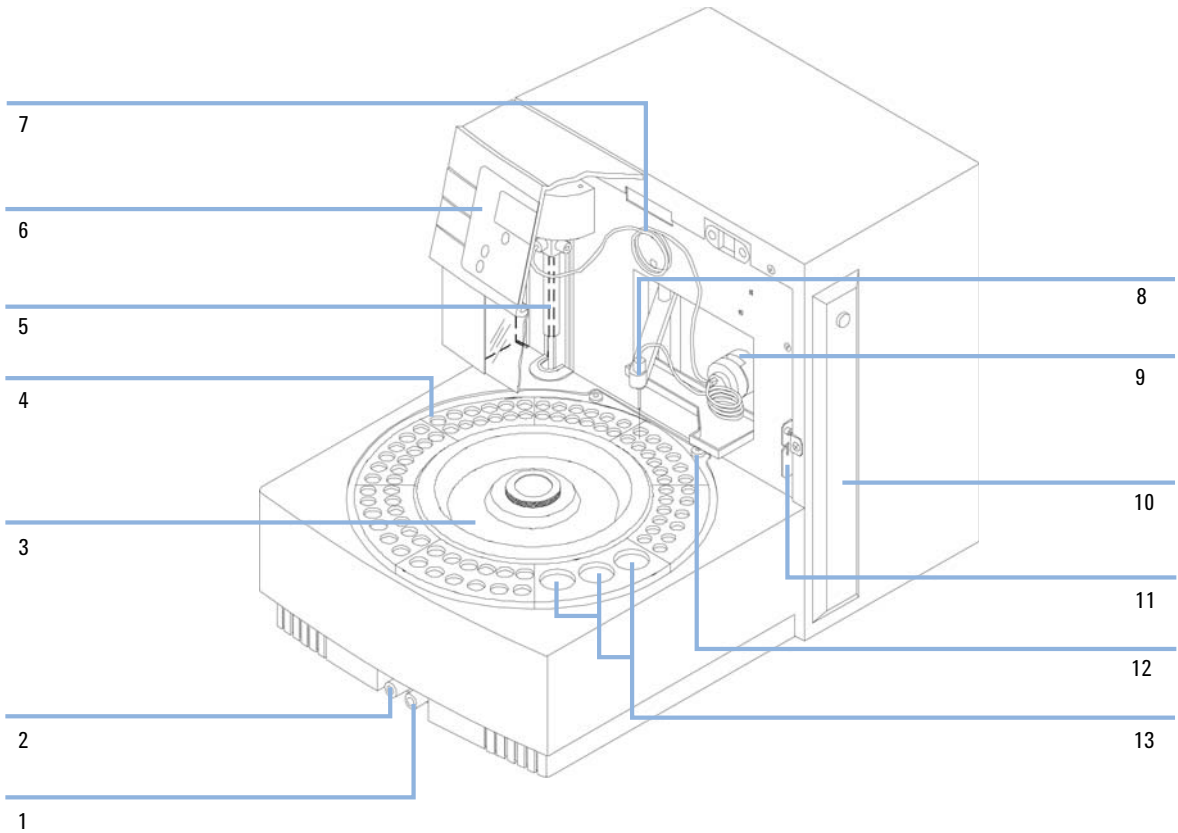

**Figure 18** Autosampler overview

### 3 Installation

#### Installing the Autosampler

1	Vial wash drain
2	Condensed water and leakage drain
3	Tray fixation knob
4	Sample tray
5	Syringe dispenser
6	Keyboard
7	Buffer tubing
8	Needle arm
9	Injection valve
10	Oven compartment
11	Tubing guide
12	Wash position
13	Position for transport solvent and reagent vials

The rear view of the autosampler is shown in [Figure 19](#) on page 87.

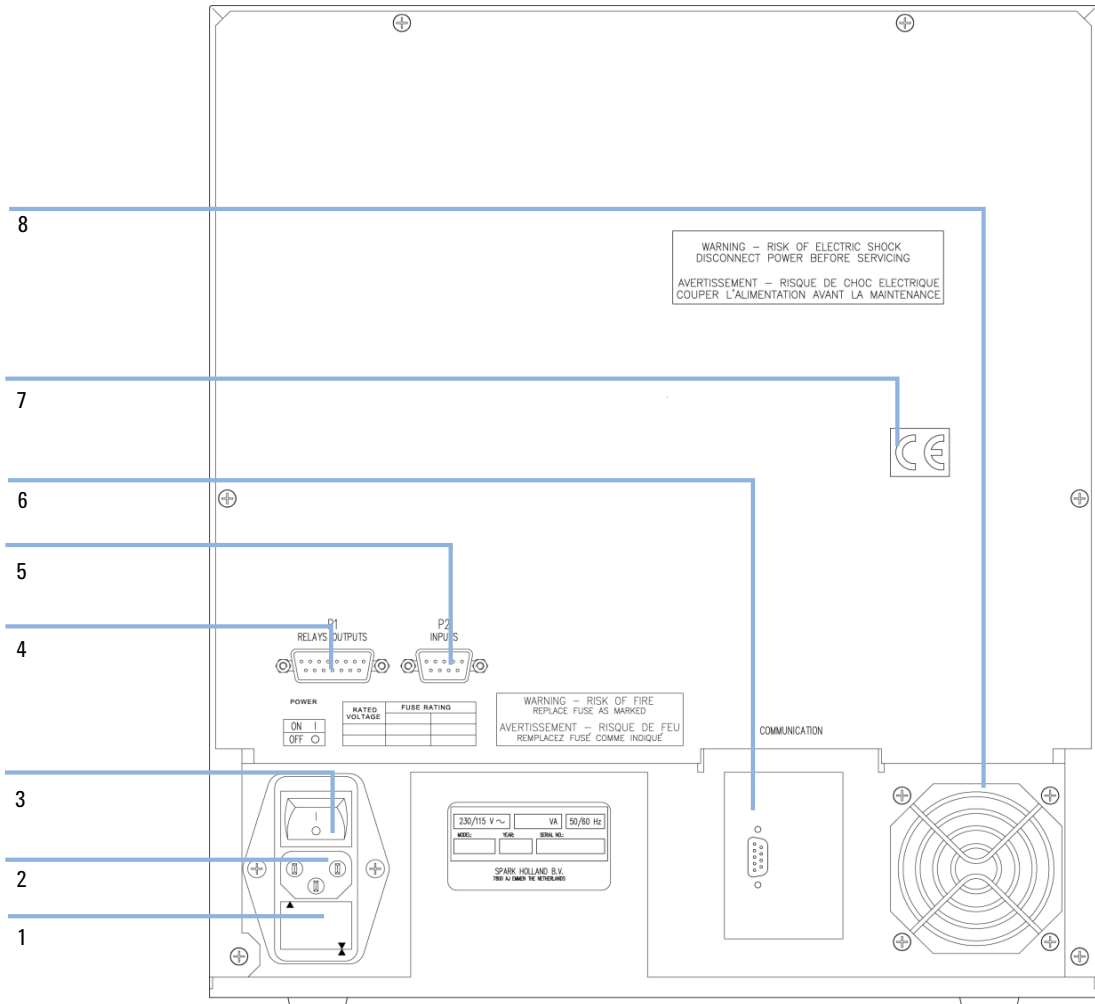

**Figure 19** Rear View of the autosampler

### 3 Installation

#### Installing the Autosampler

1	Fuses and voltage selector
2	Main input
3	Main switch
4	P1-I/O connector
5	P2-I/O connector
6	RS-232 communication interface connector
7	CE-mark
8	Fan (only if optional Peltier tray cooling option is installed)

## Installing the Sample Tray

- 1 Place the sample tray in the autosampler and rotate it until the tray drops into the slot, only one position is possible.
- 2 Turn the tray fixation knob clock-wise to fixate the tray (see [“Overview of the Module”](#) on page 85 for an overview).

## Connecting the Waste Tubings

The following Waste Tubings must be connected to the autosampler:

- General waste tubing
- Syringe waste tubing
- Water and leakage drain

### Connecting the General Waste Tubing

- 1 Connect the drain tubing to the right-hand drain hose connector of the autosampler and put it in a bottle which is placed on the floor.  
All the liquid dispensed while the autosampler is in the wash position is removed through this drain



### Connecting the Syringe Waste Tubing

- 1 Place the syringe waste tubing into a small bottle next to the autosampler. If no injection volumes are programmed that are larger than the buffer tubing can contain, the syringe waste will only be wash solvent.

### Connecting the Water and Leakage Drain

All solvents that result from a leak in the system and condensed water are drained through the left hand hose connector.

#### CAUTION

Risk of damaging the autosampler

Drain and waste tubing are twisted thereby obstructing the flow path.

→ Be sure that the drain and waste tubing are not twisted.

---

- 1 Connect the hose connector to a waste container on the floor.

## Starting the Autosampler

Tools required	Description
	Distilled Water
	Isopropanol
	Helium
OR	Ultrasonic bath

- Preparations**
- Allow the Agilent 410 Autosampler to reach ambient temperature for at least one hour.
  - Connect the waste tubings (see [“Connecting the Waste Tubings”](#) on page 88 for more information).

### WARNING

#### Electrical shock

**Risk of stroke and other personal injury due to reduced safety protection or unwanted fusing.**

- Ensure that the code on the fuse cap matches the information next to the fuse holders.

### WARNING

#### Risk of fire and damaging the module

- For 115 VAC  $\pm 15\%$ , use two 5 A T-fuses (slow-blow).
- For 230 VAC  $\pm 15\%$ , use two 2.5 A T-fuses (slow-blow).
- All fuses must be UL listed and CSA certified, or IEC 127 type.

### NOTE

Keep the keyboard front cover closed during operation.

- 1 Remove the safety screw on the right-hand side of the front cover.
- 2 Check fuses and voltage settings on the rear of the instrument.
- 3 Connect the power cable.
- 4 Turn the power switch to ON.  
The Ready screen appears displaying the firmware revision number.

## Rinsing the System with Wash Solvent

Tools required	Description
	Distilled Water
	Isopropanol
	Helium
OR	Ultrasonic bath

### CAUTION

Damage to the system

Crystals from salts or buffer solutions may block or damage the system.

- Never use salts or buffer solutions as wash solvents.
- Only use water/organic solvents.

- 1** Place a clean bottle for the wash solvent at the left-hand side of the autosampler
- 2** Use a mixture of distilled water and isopropanol (80 / 20 v/v %) or the mobile phase as wash solvent.
- 3** Degas the wash solvent with Helium or an ultrasonic bath.
- 4** Put the wash solvent tubing in the filled was solvent bottle.
- 5** Press **MAINTENANCE** to go the autosampler maintenance functions.
- 6** Fill the tubing using the autosampler soft-function keys **SYR END** and **SYR HOME**.
- 7** With **SYR END** a syringe volume of wash solvent is aspirated from the wash solvent bottle and the wash solvent tubing is filled. With **SYR HOME** the syringe contents will be dispensed to the syringe waste.
- 8** Repeat this action until the wash solvent tubing and the syringe are completely filled and no air bubbles appear in the syringe.
- 9** Press **Escape** to leave the maintenance screen.
- 10** After the wash solvent tubing and the syringe are filled, press **WASH** to perform a standard wash routine. Repeat the wash routine 2 or 3 times. All tubing connected to the syringe valve will be rinsed with wash solvent.

### NOTE

The autosampler will give the best results if all air is removed from the syringe.

## Connecting the HPLC to the Autosampler

To ensure reproducible injections the following connections to your HPLC system should be made:

- 1 Connect the HPLC pump to port 1 of the injection valve.
- 2 Connect the HPLC column to port 6 of the injection valve.
- 3 Check for leakage and let the system equilibrate for at least 5 min.

### NOTE

The instrument is flushed with Isopropanol. Make sure that the mobile phase of your HPLC system is miscible with Isopropanol. If your mobile phase is not miscible with Isopropanol, then start with an intermediate solvent that is a transition to the mobile phase. To avoid possible contamination of the column, it is good practice to not have the column installed during this operation.

---

### NOTE

It is essential that the contents of the sample loop are injected as a back flush onto the column, therefore do not exchange column and pump connections at the injection valve.

---

## Filling and Sealing the Vials

- 1 Fill the standard vials, as well as the conical vials by means of a narrow-end pipette to allow air to escape when filling the vial.

### NOTE

Do not fill vials completely to the top. In that case sample will be forced into the air needle, risking cross-contamination of samples and fouling of the needle pair.

---

- 2 Check that the seal is airtight due to maintain a pressure on the vial for air bubble prevention and to prevent evaporation of volatile samples.
- 3 Check seal after crimping, if the cap can be turned easily, the seal is not airtight (re-adjust hand crimper).

### NOTE

When using uncapped vials, the performance of the AutoSampler may not meet the specifications (precision). Do not re-use a sample vial without replacing its cap or septum.

---

## Loading the Sample Tray

- 1 Place the vial in the tray and link them to methods in the Series. For details, see Agilent 410 Autosampler - User Manual (G9331-90000), Chapter *Using*, section *Programming the Run Sequence or Series*.
- 2 If the autosampler is not running, manually rotate the tray to gain access to all vial positions.

## Installing the Agilent 410 Autosampler Prep Option

- 1** Replace the standard injection valve with the special Agilent 410 Prep valve.
- 2** Replace standard sample needle, air needle and buffer tubing with the ones supplied in Prep Upgrade Option, Includes Needle, Syringe, Injection Valve and Large Volume Sample Tray (393590791).
- 3** Re-connect all tubing to the injection valve.
- 4** Replace standard Syringe with the 2500  $\mu\text{L}$  syringe.
- 5** Install the 24 vials (LSV) tray.
- 6** Choose Prep Mode in system.

## Installing the Fraction Collector

### Overview of the Module

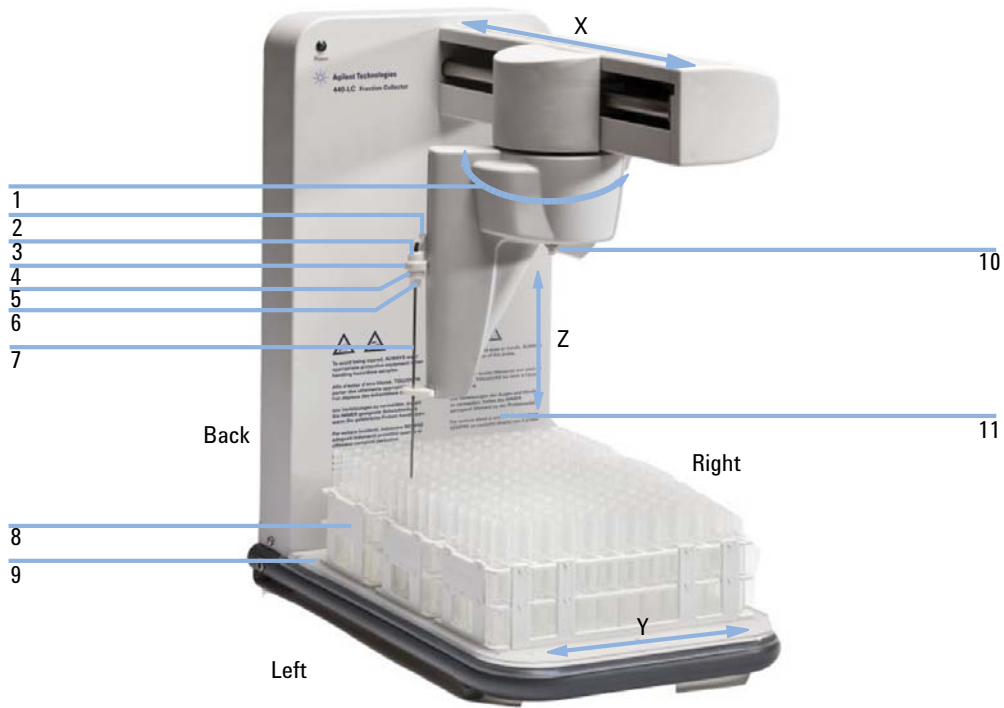

**Figure 20** Fraction collector components

1	Theta axis
2	Z axis slide
3	Top knurled mount nut on the probe assembly
4	Probe mounting block
5	Lower knurled mount nut on the probe assembly

### 3 Installation

#### Installing the Fraction Collector

---

6	Nut holding the metal probe
7	Probe
8	Rack
9	Rack location mat
10	Split retaining ring
11	Fraction collector pillar (control column)

---

## Installation Overview

Basic installation involves:

- Assembling the fraction collector
- Connecting the fraction collector to the HPLC system
- Installing Agilent OpenLAB CDS ChemStation PrepLC Drivers
- Determining the delay volume and probe depth

### NOTE

All external DIP switches should always be in the *OFF* position.

## Assembling the Fraction Collector

Carefully follow the instructions provided below to assemble your instrument.

Assembling the Agilent 440 Fraction Collector includes installing the:

- 1 Spill tray
- 2 Rack location mat
- 3 Probe and tubing
- 4 Sample racks

### NOTE

Position the fraction collector on the side of the HPLC system closest to the detector output to help decrease the delay volume.



## Installing the Spill Tray

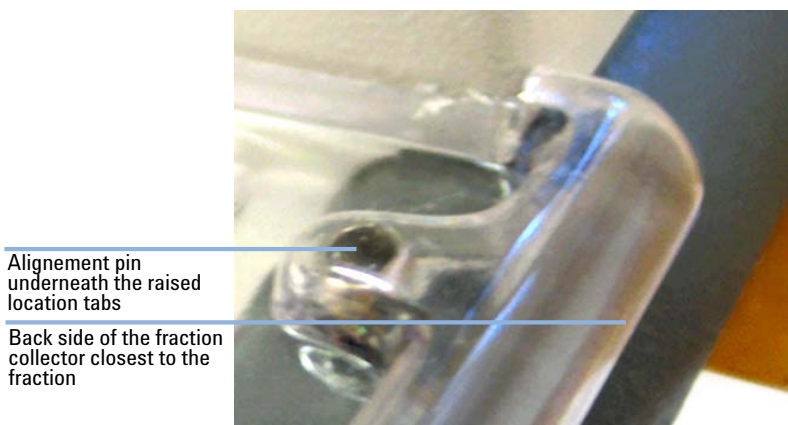

**Figure 21** Spill tray alignment pin and mat for the rack location raised locating tabs

### Preparations

Position the fraction collector closest to the detector output. This decreases the delay volume.

### NOTE

The spill tray will catch most solvent spills. Always clean up spills immediately.

- 1 Locate the alignment pins protruding above the base support tube.
- 2 Lower the tray so that the two alignment pins closest to the fraction collector pillar fit into the slots in the spill tray.
- 3 Lower the spill tray until the front edge rests on the front of the base support tube.
- 4 Check that the spill tray is firmly pushed down on all alignment pins.

### NOTE

The spill tray must be firmly in position so that it does not move.

## Installing the Rack Location Mat

The rack location mat is installed on top of the spill tray.

**Preparations** Spill tray installed

### NOTE

There are cut-outs around the rack location mat. The cut-outs slot over the raised locating tabs that are molded into the spill tray to ensure proper alignment (see [Figure 22](#) on page 102).

- 1 Position the rack location mat over the spill tray and press the mat onto the locating tabs.
- 2 Check that the rack location mat fits firmly in place by trying to move it side to side. There should not be any movement. If the rack location mat is loose, refit it.

## Installing the Probe and Tubing

The sample probe comes preassembled with 0.050 cm (0.020 in) ID tubing. There are three additional coils of tubing included in the probe kit.

- The longer piece of tubing with a nut and ferrule is used for the drain tube on the divert valve.
- The shorter tubing with a nut and ferrule is used to connect fraction collector divert valve to the sample output from the HPLC system.
- The third piece of tubing is 0.025 cm (0.010 in) ID tubing and can be used for low delay volumes for applications with flow rates of 2 mL/min or less.

For details on installing the tubing, refer to Agilent 440 Fraction Collector - User Manual (G9340-90000).

- 1 Turn off the fraction collector.
- 2 Slide the Z-axis slide to the top of the probe carriage.
- 3 Manually rotate the probe arm so that it can be easily accessed.

- 4 Disassemble the probe kit by unscrewing the nut holding the metal probe from the bottom of the lower knurled mount nut and then the lower knurled mount nut from the top knurled mount nut.

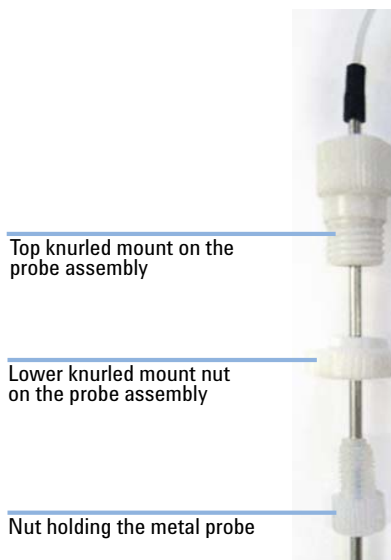

- 5 Insert the probe into the probe mounting block (see [Figure 20](#) on page 95).
- 6 Push the tubing down into the probe so that at least 0.5 cm tubing protrudes from the end of the probe.
- 7 Secure the lower knurled mount nut to the top knurled mount nut.
- 8 Secure the nut holding the metal probe into the bottom of the lower knurled mount nut.
- 9 Clip the tubing into the tube restraint which is the small hook at the top of the Z-axis slider. Allow for a small length in the tubing to prevent kinking the tubing.
- 10 Run the tubing along the back side of the probe arm housing.

### 3 Installation

#### Installing the Fraction Collector

- 11 Attach the split ring (also called the retaining ring) as shown below. The retaining ring is split to attach it through the loop on the underside of the probe arm housing.

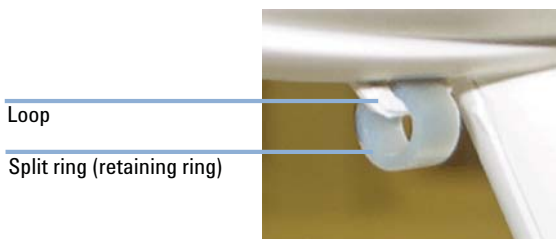

- 12 Feed the tubing through the retaining loop attached to the underside of the housing.

- 13 Screw the tubing fitting into the bottom (port 3) of the valve.

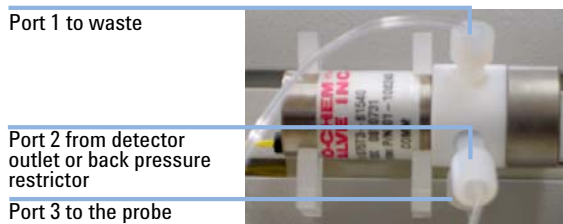

#### NOTE

It is important to ensure that the length of the tubing from the probe to the valve allows the probe arm to move freely in all axes. If it is too tight, it will restrict movement and may cause movement failure. If it is too loose, the probe arm may become tangled in the tubing as it moves. Tubing length between the valve and the detector depends on fraction collector placement. When choosing the length of tubing ensure it is long enough to allow free movement of the arm but not too long to delay sample delivery into the tubes. If the tubing is too long between the detector output and the fraction collector probe end, your samples may not correspond correctly to the fraction collector markers on your chromatogram. The delay volume calculation will compensate for this effect.

- 14 Move the probe arm to the front-right side of the fraction collector and rotate the probe arm fully to the right to check that the tubing is completely free to move.
- 15 Manually position the probe arm in the middle along the X axis.
- 16 Rotate the probe arm through its full extent to check that the tubing is free to allow full movement in all directions.

**NOTE**

If the length is not correct, remove and then replace the tubing, install the fittings and tubing onto the fraction collector. Repeat step 14 on page 100 - step 16 on page 100 to test the tubing length

---

**17** Adjust the length of the sample line from the HPLC system. In port 2 (see [Figure](#) on page 100) screw in the fitting with ETFE tubing. Connect the other end of this tubing to the HPLC system's detector outlet or to the back pressure restrictor if one is present.

**NOTE**

This tubing should be as short as possible.

---

**18** In port 1 (see [Figure](#) on page 100) screw in the fitting with PTFE tubing. Put the other end of the tubing into your waste container.

## Assembling the Sample Racks

**CAUTION**

Loss of sample

If a tube sits at an angle in the rack, the probe may hit the side of the tube as it enters or leaves the tube. This can affect the alignment of the probe and/or damage the tube.

→ Ensure that the tubes sit vertically within the sample rack.

---

- 1** Follow the manufacturer's instructions to assemble the sample racks.
- 2** If needed: Insert the overlay by placing the overlay over the top of the rack.

## Installing the Sample Racks

**1 Standard racks:**

- Fit the pegs on the rack into the holes on the rack location mat. The rack closest to the pillar of the fraction collector is considered rack number one.

OR

*Autosampler rack (Type 128 or Type 200):*

- Slide the extended portion on the bottom of the rack into the long slit on the rack location mat.

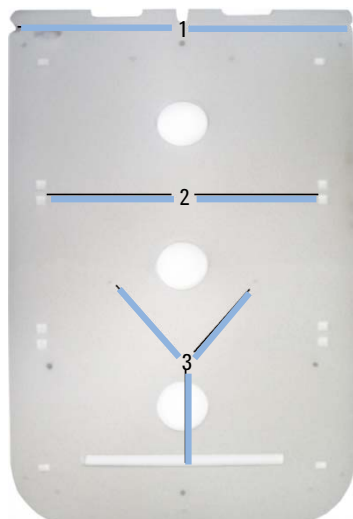

**Figure 22** Rack location mat

1	Cut-outs on the rack location mat
2	Holes for regular tube racks
3	Holes for the autosampler rack

## Rack Orientation

- 1 Place the rack in the correct orientation to get your samples in the desired order.

The following image shows an example of where the first sample is delivered to and the orientation of the regular racks provided with the fraction collector.

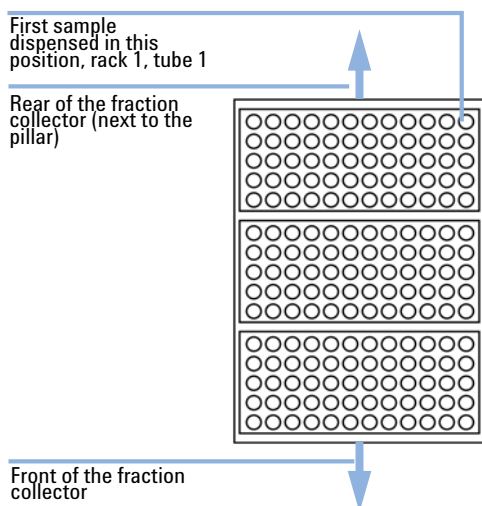

**Figure 23** Tube positions on the fraction collector

## Connecting the Power to the Fraction Collector

The connection panel of the Agilent 440 Fraction Collector (G9340A) is located on the pillar (also called a control column). The panel contains an I/O port, indicators, DIP switches, the power socket and switch, and a RS 232 port for communication between the Agilent 440 Fraction Collector (G9340A) and the system (or computer) that is running instrument control software.

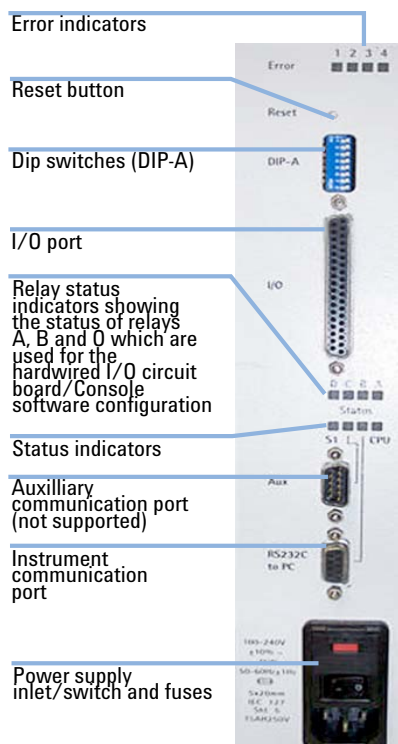

Figure 24 Connection panel

### Prerequisites

Three power cables are supplied with the module. Select the correct one for your location.

### WARNING

#### Electrical shock

**Electrical power for the module must be provided through a three wire outlet with ground connection. The outlet must be rated for at least 75 VA.**

→ Ensure that power receptacles are earth-grounded at the grounding pin.



**NOTE**

Ensure that the probe arm's movement is not interfered with during operation/initialization.

- 1 Ensure that the power switch is turned off (0).
- 2 Plug one end of the power cable into the module (both the switch and the power socket are located on the connection panel on the pillar) and the other into the mains power outlet.

**NOTE**

In some countries, it may be necessary to fit a suitable three pin power plug to the cord. A three pin earthed power outlet must be used.

Ensure the module is always connected to the mains supply protective earth.

- 3 Turn on the module.

The module will go through initialization tests and set the probe position. If the initialization process is not successful, refer to chapter Troubleshooting and Diagnostics in Agilent 440 Fraction Collector - User Manual (G9340-90000).

If the fraction collector does not start up, check each fuse as described in chapter maintenance in Agilent 440 Fraction Collector - User Manual (G9340-90000).

During the initialization sequence:

- 1 The probe rises to the full extreme of the Z axis.
- 2 The probe travels to the full extremes of the X axis and rotates to the full extremes of the Theta axis.
- 3 Then the probe is positioned at the front-left of the fraction collector.

### Instrument Communication Port

The instrument communication port, see [Figure 24](#) on page 104, is used to connect the Agilent 440 Fraction Collector (G9340A) to the computer or MIB controlling the instrument.

### Auxiliary Communication Port

The auxiliary communications port provided on the Agilent 440 Fraction Collector (G9340A) is not used with current Agilent software or hardware.

## Connecting the Fraction Collector to the HPLC System

For details on setting up the fraction collector to the HPLC System, see [“Setup the System with OpenLAB CDS ChemStation Edition - Control Panel”](#) on page 116.

## Determining the Delay Time

- 1 For information refer to the online help of the Agilent 440 Fraction Collector.

## Determining the Correct Probe Depth

- 1 For information refer to the online help of the Agilent 440 Fraction Collector.

## Installing the RS-422/485 Communication Kit

- 1 Connect the Serial extension cable (R000815107) to the end of RS-422 connector on the Converter RS-232 to RS-422 (393597601).

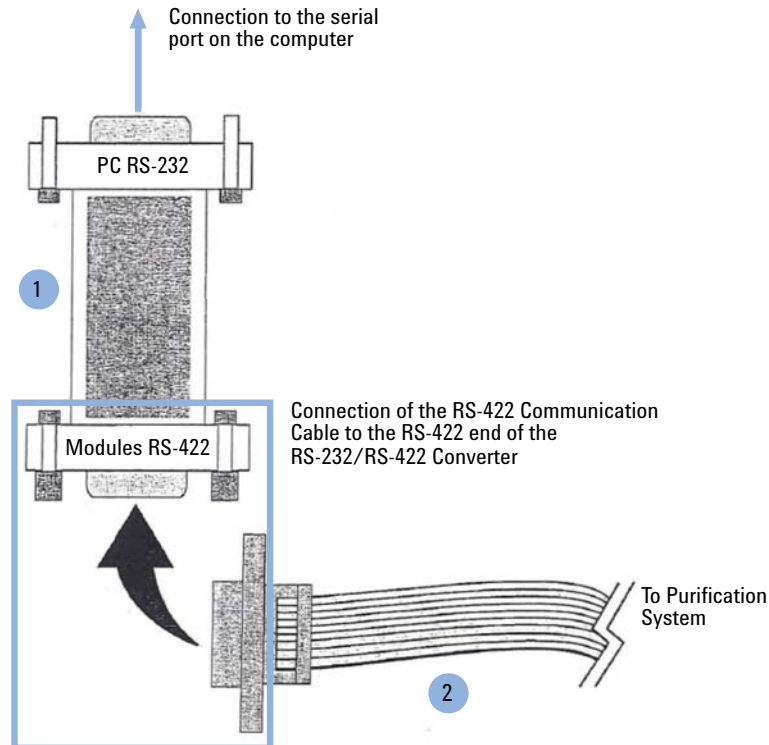

- 
- |   |  |
|---|--|
| 1 | Converter RS-232 to RS-422 (393597601) |
| 2 | Serial extension cable (R000815107)    |
-

### 3 Installation

#### Installing the RS-422/485 Communication Kit

- 2 Connect the 9-pin "D"-shell connector on the RS-232 end of the Converter RS-232 to RS-422 (393597601) to a serial communication port on the computer.

#### NOTE

The screws on the RS-232 end of the RS-232/RS-422 Converter should be screwed into the nuts on the computer 9-pin "D"-shell serial port connector.

---

## Installing the Stream Splitter

Agilent Stream Splitters are designed for preparative HPLC applications with flow rates up to 1200 mL/min to split stream between preparative HPLC detector and an analytical detector. If modules in the flow pass are not capable of the pressure, the stream splitter must be installed. PCG426000001 is designed for flow rates up to 200 mL/min. It uses 1/16 inch connection fittings (PTFE tubing). PCG426000002 is designed for higher flow rates up to 1200 mL/min. It uses 1/8 inch and 1/16 inch connection fittings (PTFE tubing), depending on the detector being used. Some tubing's and fitting are supplied to connect with both preparative and analytical flow cells as required.

- 1** Install the stream splitter as close as possible to the outlet of the UV detector, the inlet of the ELSD and the fraction collector.
- 2** Cut the appropriate lengths of the chosen diameter tubing.
- 3** Install outlet from the UV detector to the IN port on the stream splitter.
- 4** Connect the OUT port on the stream splitter to the fraction collector.
- 5** Connect To Detector port in the back of stream splitter to the ELSD detector.

## Setup Hardware

### Setup the Hardware

This is done on the modules regardless of whether you are using HPLC control software or using one of the pumps as a master controller including following modules:

- Different pumps,
- 325 UV/VIS Dual WL Detector,
- 440 Fraction Collector, and
- 410 Autosampler.

## Setup the Pump

### NOTE

The correct setup of the pump depends on the pump head installed. Choices are: 5 , 10 , 25 , 50 , 100 and 200 mL/min, 10P, 25P, 50P, 100P.

The P designation stands for PEEK. The compressibility compensation for PEEK heads is different than for stainless steel or titanium heads.

### Setup Pump ID for Pump 1

- 1 Turn the module on.
- 2 Press on the Pump keyboard:
  - **Setup** and then
  - **Enter**

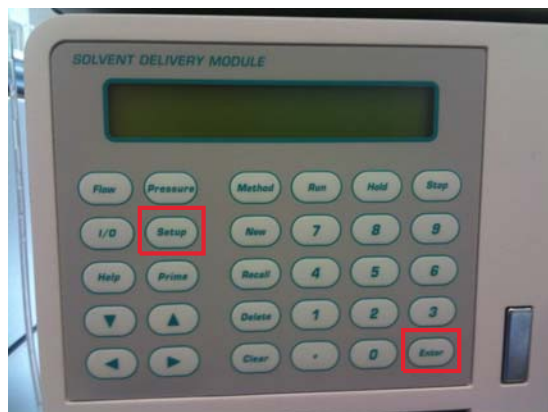

- 3 With the left arrow key select:
  - **ID of the Pump: 1**
  - **HDSZ (Pump head): xx** (depends on what pump head is installed - for choices see Note above)
  - **Refill: 125 (piston)**
  - **CIM: 5**
- 4 Press **Enter**.
- 5 Reboot the module.

### 3 Installation

#### Setup Hardware

#### Setup Pump ID for Pump 2 (if Exist)

- 1 Turn on the Pump 2.
- 2 Press on the Pump keyboard:
  - **Setup** and then
  - **Enter**

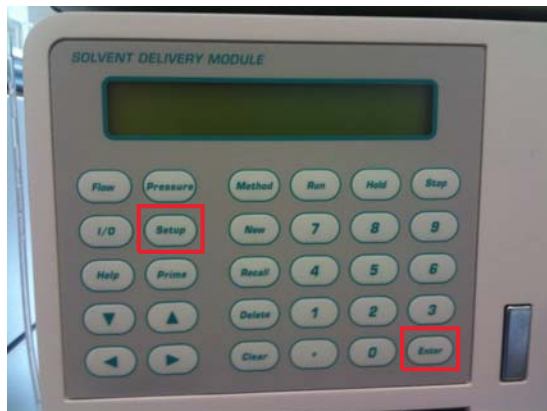

- 3 With the left arrow key select:
  - **ID of the Pump: 2** (available choices are: 0 – 63 , **MC** (master controller) or – (no ID).

#### NOTE

For OpenLAB, an ID between 1 – 63 must be used.

- **HDSZ (Pump head): xx** (depends on what pump head is installed - for choices see Note above)
  - **Refill: 125 (piston)**
  - **CIM: ----**
- 4 Press **Enter**.
  - 5 Reboot the module.



## Setup the Autosampler

### Preparation for general and tray settings:

- 1 Press **Serial** on the autosampler keyboard.

### To set up the general system settings:

- 1 Turn the module on.
- 2 Press **SYSTEM**.
- 3 Press **GENERAL**
- 4 Confirm or change each of the settings that appear on the display:
  - Volume of installed loop (0 – 5000  $\mu$ L)
  - Volume of tubing "needle↔valve" 0 – 999  $\mu$ L
  - Syringe volume (250 /1000 )
  - Syringe speed (**LOW/NORMAL/HIGH**)
  - Skip missing vials (**YES/NO**)
  - Air segment (**YES/NO**)
  - Headspace pressure (**YES/NO**)

### To set up the tray settings:

- 1 Turn the module on.
- 2 Press **SYSTEM**.
- 3 Press **Tray**
- 4 Confirm each of the tray settings that appear on the display:
  - Tray type (84 +3 /9 /24 )
  - Vial type (STANDARD/2.5 mL)
- 5 Reboot the module.

## Setup the Detector

The detector is set up at the factory with a BOOTP (or DHCP) IP address. If need be, this can be changed by a trained service engineer who will own a copy of the diagnostics software or by setting up Agilent BootP Service to provide the detector with the right IP details.

## **Setup the Fraction Collector**

The Fraction Collector is ready to be set up in OpenLAB and does not need to have the hardware set up.

## Setup the Software

### Install Agilent OpenLAB CDS ChemStation PrepLC Drivers

<b>Parts required</b>	<b>p/n</b>	<b>Description</b>
	M8301AA	OpenLAB CDS ChemStation Edition Workstation A.01.05 or higher
	M8500AA	M8500AA LC driver
	M8366-64000	OpenLAB CDS Installation Driver Prep LC
	M8367-64000	OpenLAB CDS Installation Upgrade Driver Prep LC
<b>Hardware required</b>	Computer with <i>OpenLAB CDS ChemStation Edition</i> installed. For details refer to the <i>OpenLAB WorkStation Installation Guide</i> .	
	<ol style="list-style-type: none"> <li data-bbox="365 796 1253 826">1 Copy AgilentDriversPrepLCChemstationSet_up.msi from CD to your computer.</li> <li data-bbox="365 840 1286 900">2 Doubleclick on AgilentDriversPrepLCChemstationSet_up.msi and follow the steps in the setup wizard.</li> </ol>	

## Setup the System with OpenLAB CDS ChemStation Edition - Control Panel

### Preparations

- Latest driver package installed, see OpenLAB CDS Installation Driver Prep LC (M8366-64000)
- Modules are wired as described in “Cable Connections” on page 139
- All modules are setup as described in “Setup the Hardware” on page 110
- All modules are switched on

### OpenLAB configuration

- 1 Open the **Agilent OpenLAB Control Panel** and select **Create > Create Instrument**.

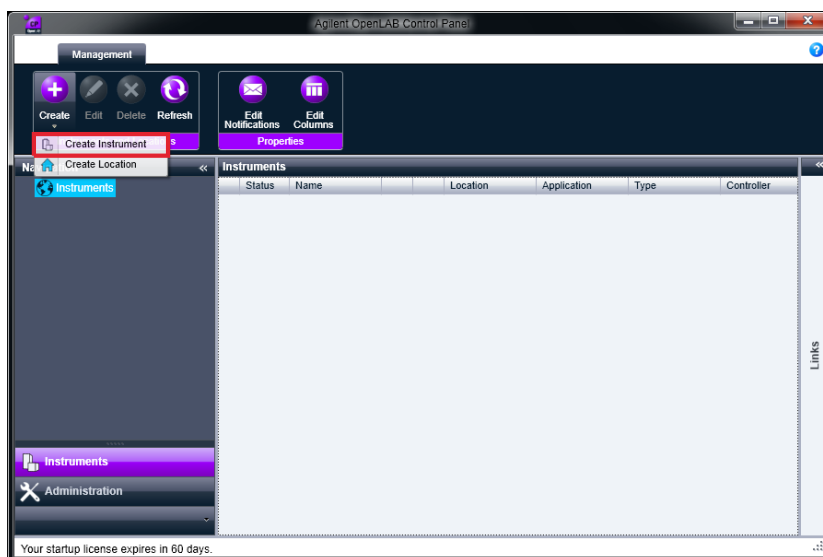

- 2 Define the **Name** (Example **PrepLC**).

3 Select **Agilent LC System** from the **Instrument type** drop-down list.

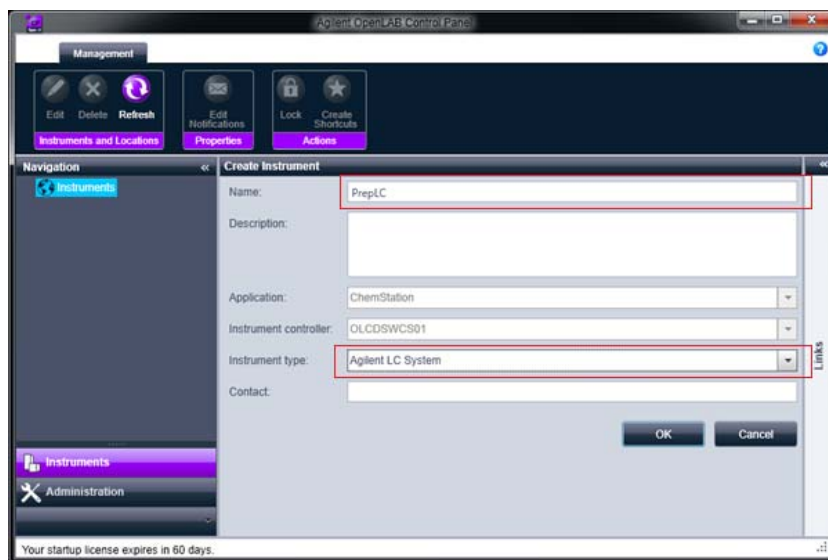

4 Select **Configure Instrument**.

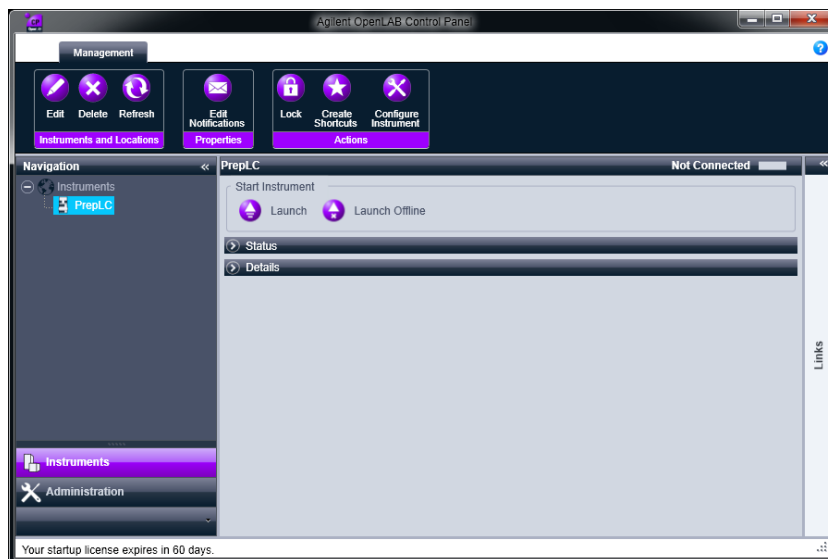

### 3 Installation

#### Setup the Software

- 5 Select **No** to avoid the auto-configuration (It doesn't work with this version).

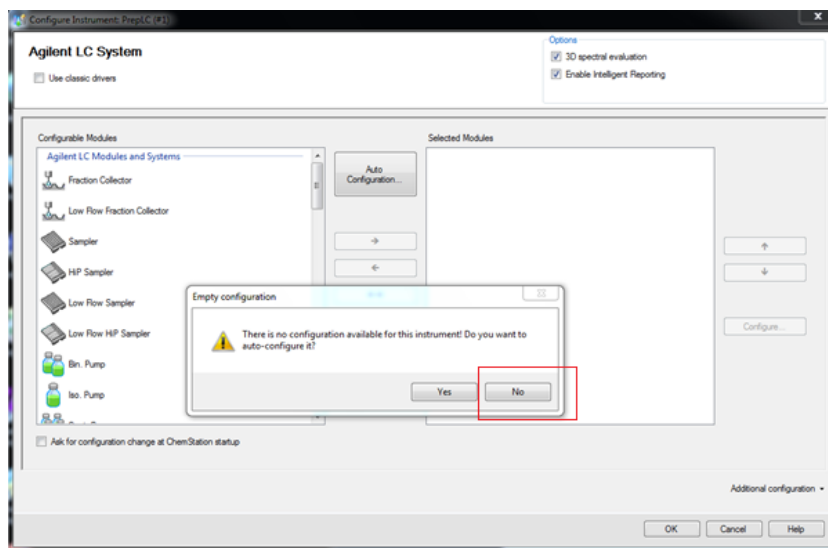

- 6 The left panel of the **Configurable Modules** contains the **Agilent Prep LC**.

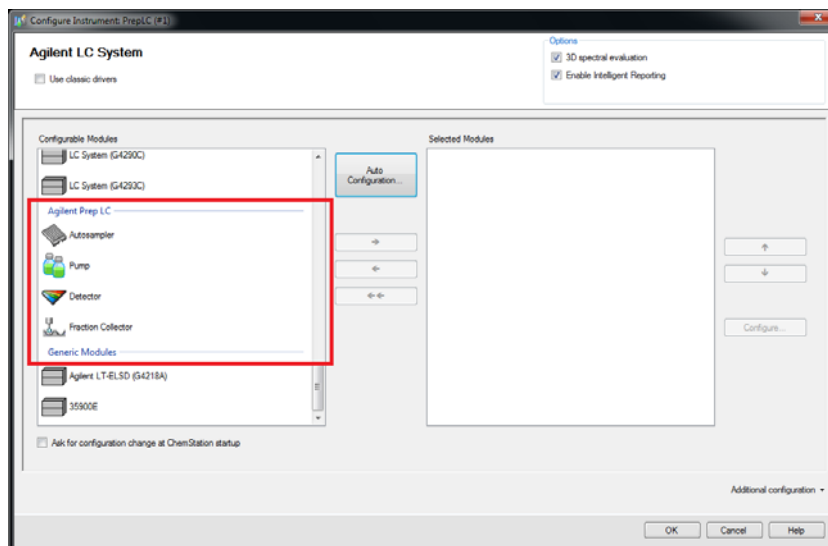

- 7 Select the module you have available in your system.
- 8 Click → to add the modules to the **Selected Modules**.  
The configuration dialog for the selected module opens.

## Pump Configuration

- 1 Doubleclick in **Configurable Modules** on Pump.  
**Pump Configuration** dialog opens.
- 2 Select the COM Port as COM 1 and the desired Pressure unit bar (available kPa, PSI, bar, MPa).

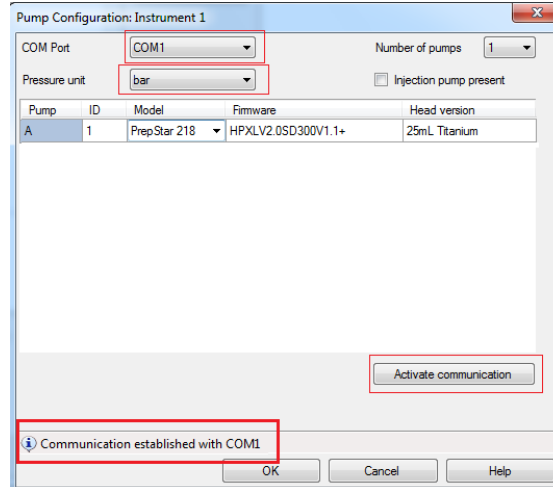

- 3 Verify the connection by clicking on **Activate communication**.  
Information **Communication established with COM1** is visible on the screen.
- 4 Click **OK**.  
Configuration dialog closes.

### 3 Installation

#### Setup the Software

#### Autosampler configuration

- 1 Doubleclick in **Configurable Modules** on Autosampler.  
**Autosampler Configuration** dialog opens.
- 2 Select the **COM Port** as **COM 1**.

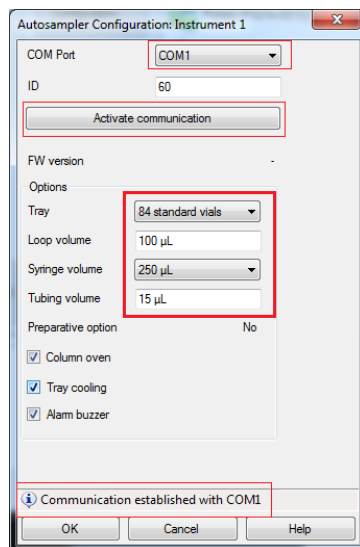

- 3 Select the **Tray84 standard vials** as an example.
- 4 Double check your actual configured Tray.
- 5 Check the other variables present in the **Autosampler Configuration** screen.
- 6 Verify the connection by clicking on **Activate communication**.  
Information **Communication established with COM1** is visible on the screen.
- 7 Click **OK**.  
Configuration dialog closes.



## Detector Configuration

- 1 Doubleclick in **Configurable Modules** on Detector.

**Detector Configuration** dialog opens.

- 2 Select the Browse function  to start discovery your Detector

The IP address will be populated by the searching results.

Example:

IP address 192.168.0.97

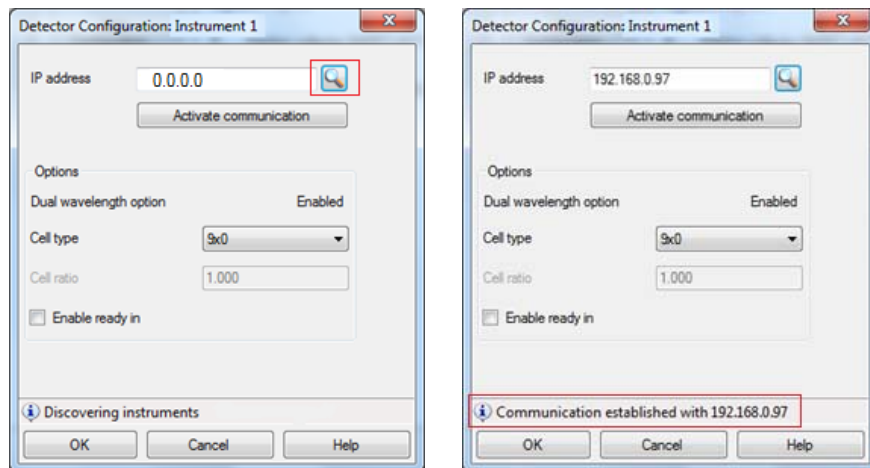

- 3 Verify the connection by clicking on **Activate communication**.

Information **Communication established with COM1** is visible on the screen.

- 4 Click **OK**.

Configuration dialog closes.

### 3 Installation

#### Setup the Software

#### Fraction Collector Configuration

- 1 Doubleclick in **Configurable Modules** on Fraction Detector.  
**Fraction Collector Configuration** dialog opens.
- 2 Select the **COM Port** as **COM 2**

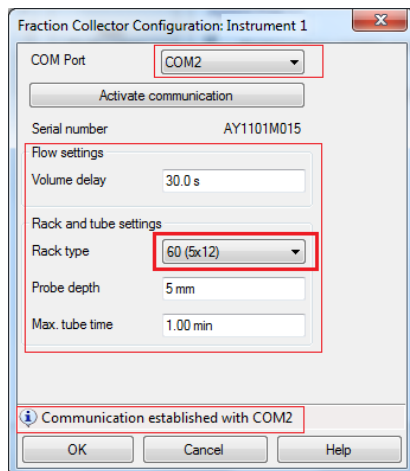

- 3 Fill in the **Flow settings** and the **Rack and tube settings**.
- 4 Verify the connection by clicking on **Activate communication**.
- 5 Verify the connection by clicking on **Activate communication**.  
Information **Communication established with COM2** is visible on the screen.

## Terminating configuration

- 1 Before closing the **Configure Instrument** windows deselect the **3D spectral evaluation** check box.

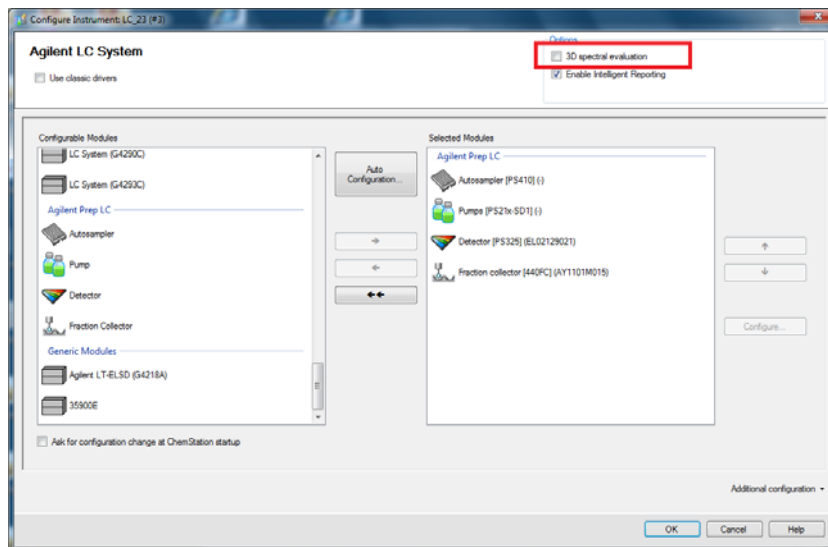

- 2 Click **OK**.

You're back in Agilent OpenLAB Control Panel.

### 3 Installation

#### Setup the Software

## Setup Method

- 1 Select **Launch** to start the OpenLab CDS Chemstation Edition.

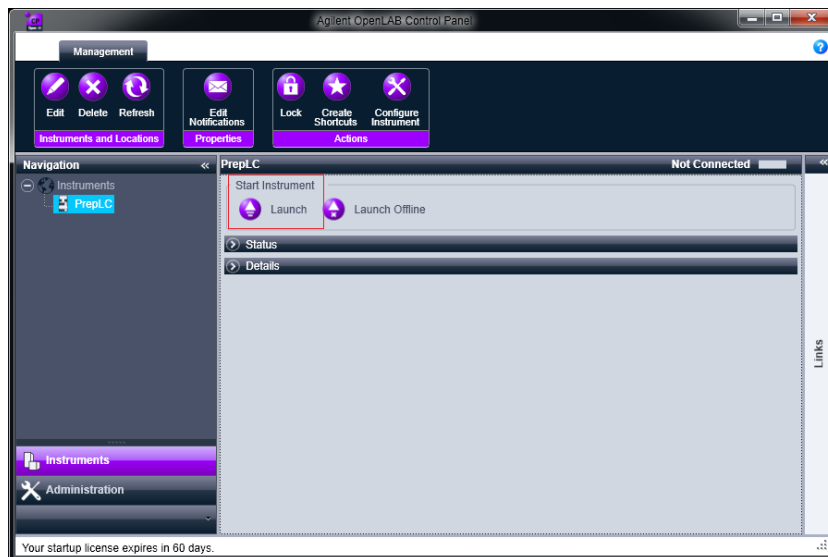

**2** Set **Pumps** parameters.

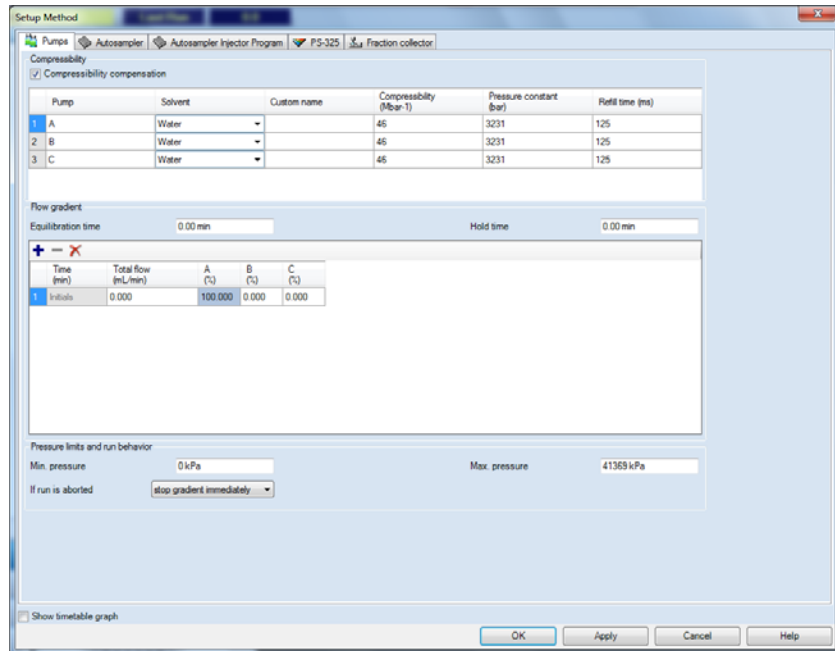

**3** Click **OK** to confirm method.

### 3 Installation

#### Setup the Software

#### 4 Set **Autosampler** parameters.

Setup Method

Pumps Autosampler Autosampler Injector Program PS-325 Fraction collector

Injection mode: Partial loopfill Syringe volume: 250 µL

Flush volume: 30 µL Transport vial: 85 Injection volume: 0 µL

Wash mode: After injection Wash volume: 250 µL

Options:  Headspace pressure  Use air segment Syringe speed: Normal

Tray:  Cooling enabled Tray temperature: 4 °C  Cooling automatic stop

Column oven:  Oven enabled Oven temperature: 30 °C

Event used	On time (min)	Oven temperature (°C)
1	0.00	30
2	0.00	30

Auxiliary 1 events  Auxiliary 2 events

Show timetable graph

OK Apply Cancel Help

#### 5 Click **OK** to confirm method.

**6 Set Autosampler Injector Program.**

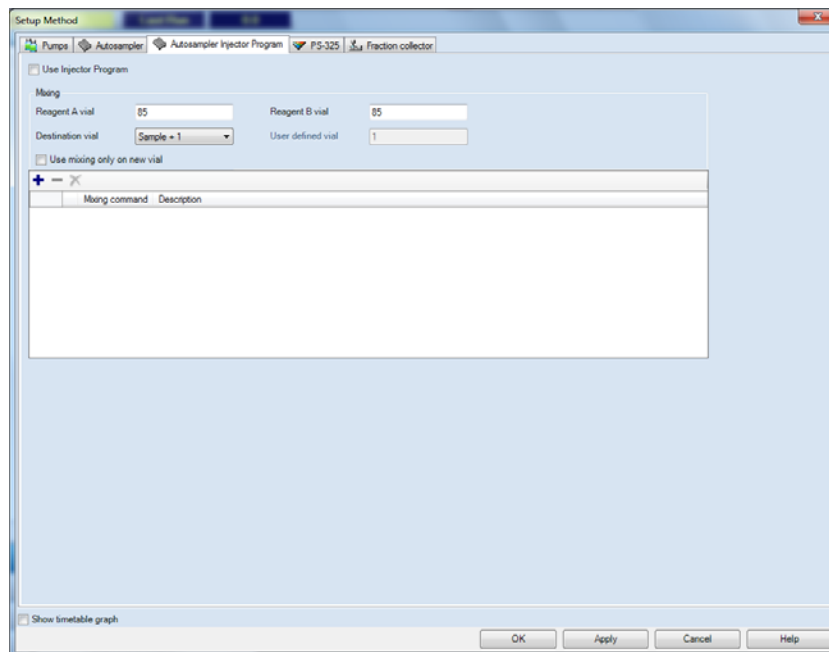

**7 Click OK to confirm method.**

### 3 Installation

#### Setup the Software

#### 8 Set **PS-325** parameters.

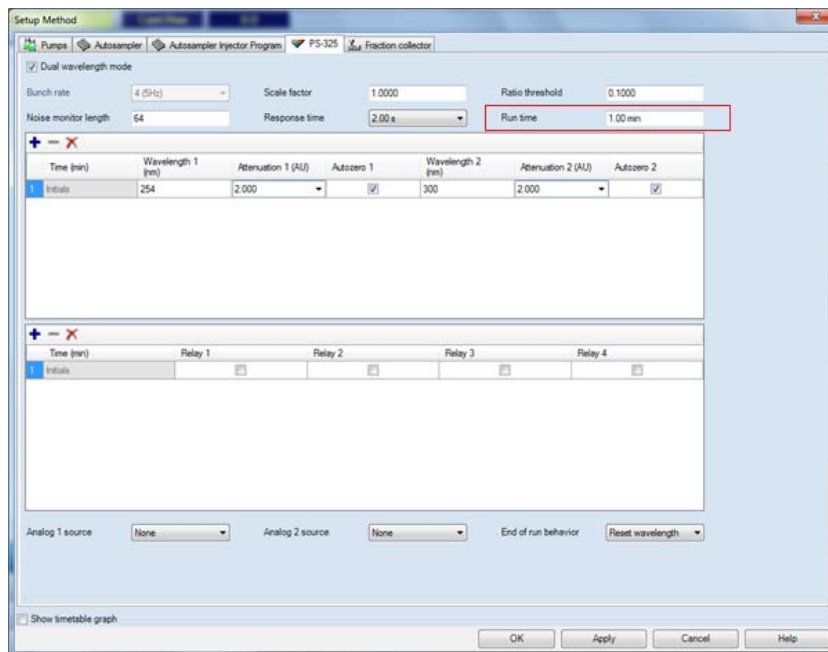

#### NOTE

The **Run time** must be defined to the detector parameters.

#### 9 Click **OK** to confirm method.



**10 Set Fraction collector.**

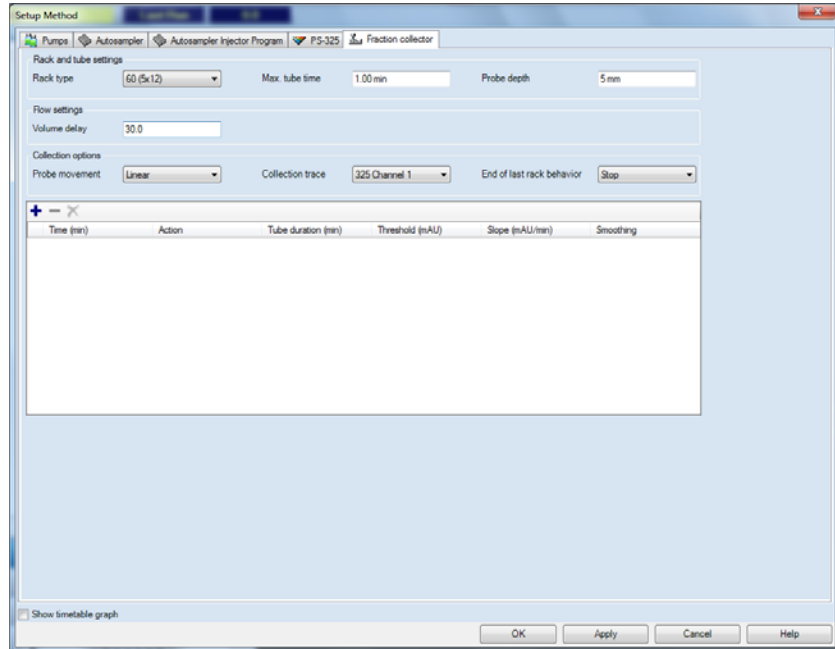

**11 Click OK to confirm method.**

Setup is completed.

## Setup the CIM in the OpenLAB CDS ChemStation PrepLC Drivers

### Setup the CIM in the OpenLAB CDS ChemStation PrepLC Drivers

The Control Interface Module (CIM) in the OpenLAB CDS ChemStation PrepLC Drivers can be used for acquiring signals from external detectors. If 218/SD-1 and 1260 modules are connected via remote cable, error messages will be properly relayed. With the remote cable it is also possible to run 218/SD-1 preparative HPLC system with any Agilent 1200 Infinity Series detector using the CIM as trigger source for fractionation. For this analog input interface one or two 218/SD-1 pump modules can be mixed.

The CIM offers different features:

- from the ability to configure the module,
- to establish communication with the module and re-establish in case of communication loss,
- to edit the CIM detector method,
- to perform a run, and acquire data,
- to view the CIM status in the RC.NET Status Dashboard,
- to activate the CIM relays manually,
- to monitor the CIM signal to fractionate, and
- to detect the 440 Fraction Collector peaks on the CIM signal.

<b>Parts required</b>	<b>p/n</b>	<b>Description</b>
	5062-3378	Remote cable
<b>Preparations</b>	<ul style="list-style-type: none"><li>• OpenLab CDS Chemstation Control Panel is configured as described in <a href="#">“Setup the CIM in the OpenLAB CDS ChemStation PrepLC Drivers”</a> on page 130</li></ul>	

1 Select **Configure Instrument**.

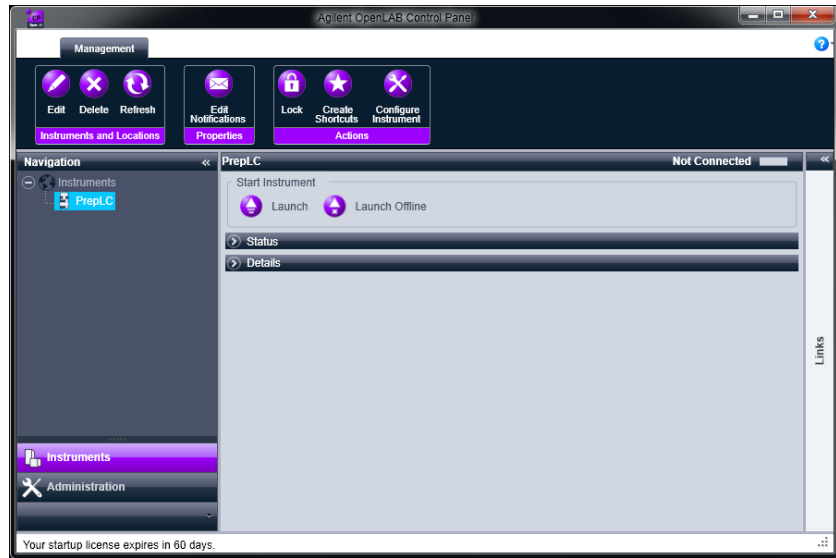

2 Select **No** to avoid the auto-configuration (It doesn't work with this version).

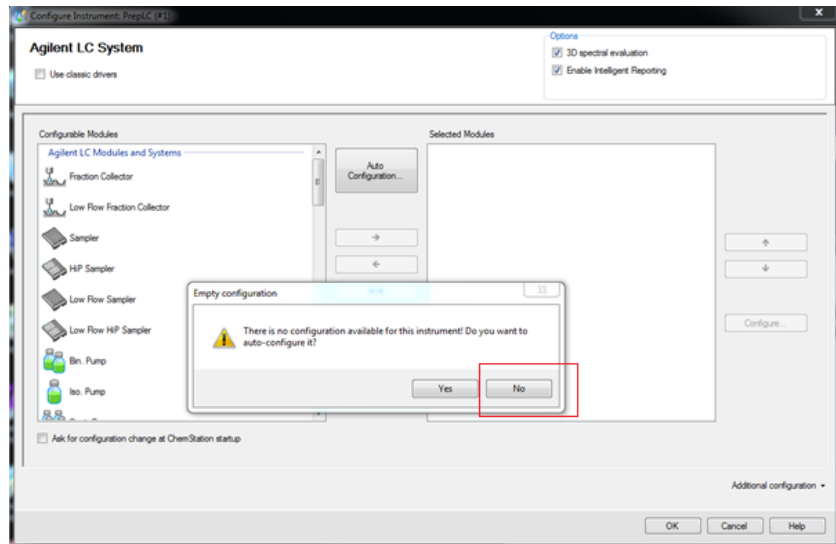

### 3 Installation

#### Setup the Software

- 3 Select the **218/SD-1 CIM** on the left panel of the **Configurable Modules**.

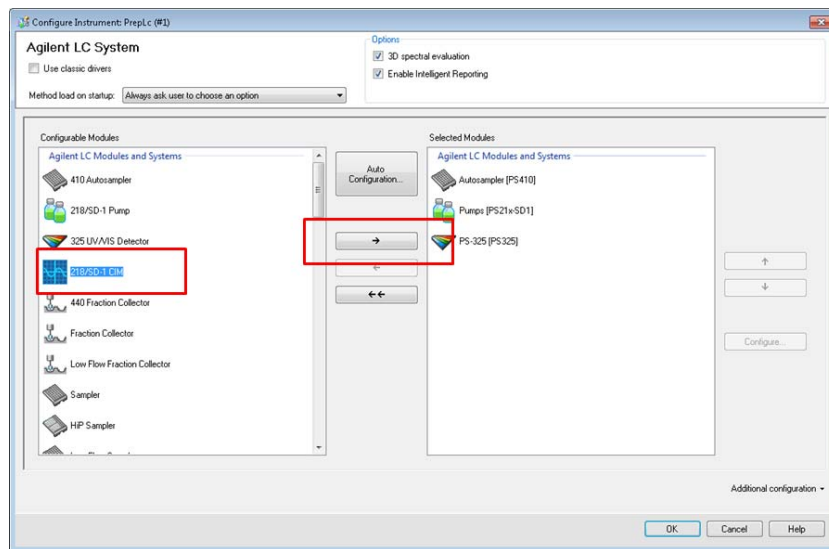

- 4 Click → to add the modules to the **Selected Modules**.  
The configuration dialog for the selected module opens.
- 5 Doubleclick in **Configurable Modules** on **218/SD-1 CIM**.  
**218/SD-1 CIM Configuration** dialog opens.
- 6 Select the **COM Port**, the **CIM Model**, **Detector ID** and enter the **ID** value.
- 7 Verify the connection by clicking on **Activate communication**.

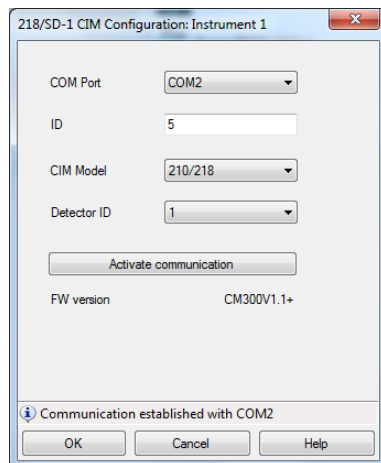

Information **Communication established with COMn** is visible on the screen.

**8** Click **OK**.

Configuration dialog closes.

**9** Doubleclick in **Configurable Modules** on **218/SD-1 Pump**.

**218/SD-1 Pump Configuration** dialog opens.

**10** Select the check box **Pulse relay 1 of pump A on start**.

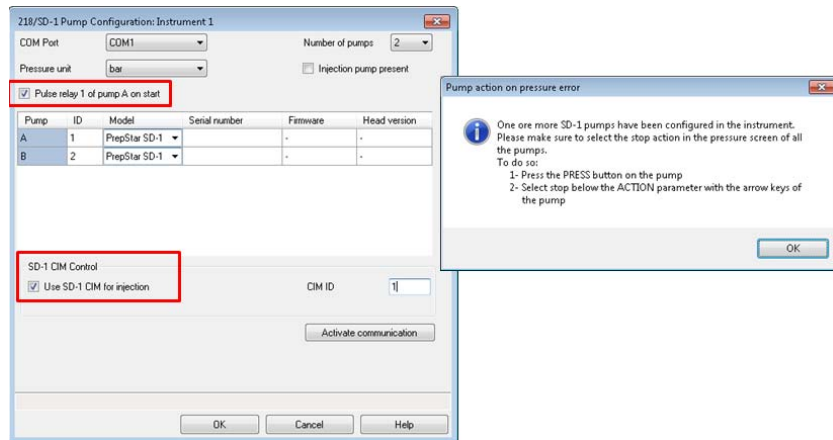

The CIM is able to send a start or stop pulse.

**11** Click **OK**.

Configuration dialog closes.

**12** Click **OK**.

You're back in Agilent OpenLAB Control Panel.

### 3 Installation

#### Setup the Software

1 Select **Launch** to start the OpenLab CDS Chemstation Edition.

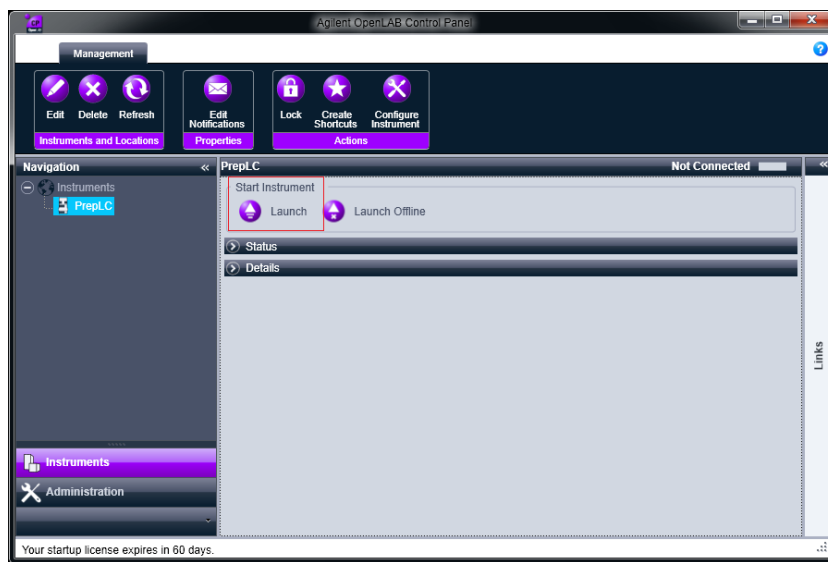

2 Set **CIM** parameters.

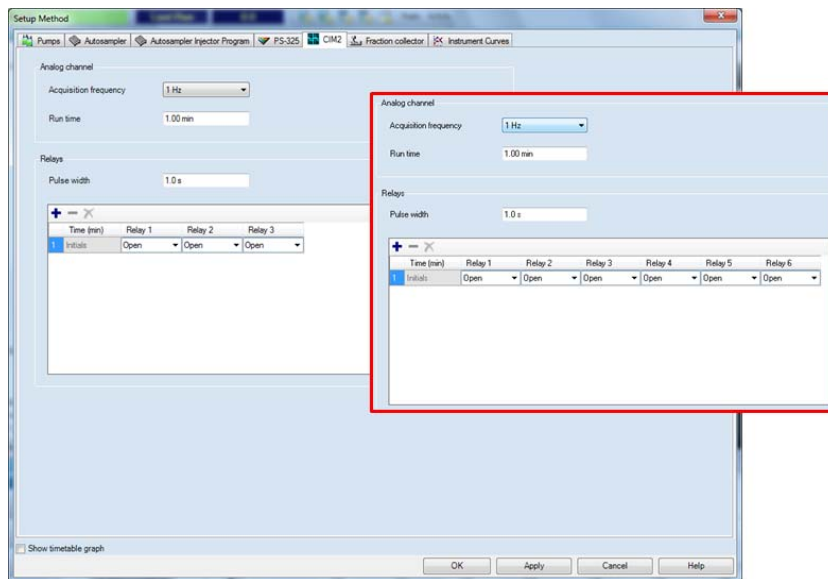

3 Click **OK** to confirm method.



## 4 Using, Troubleshooting, Maintenance and Parts

Using, Troubleshooting, Maintenance and Parts 136

This chapter provides information on how to access further details on the system components.



## **Using, Troubleshooting, Maintenance and Parts**

For details on using, troubleshooting, maintenance and necessary parts for the individual modules, please refer to the according manuals:

- Agilent 218 Solvent Delivery Module - User Manual (G9300-90001)
- Agilent 325 UV/VIS Dual Wavelength Detector - User Manual (G9309-90000)
- Agilent 410 Autosampler - User Manual (G9331-90000)
- Agilent 440 Fraction Collector - User Manual (G9340-90000)





## 5 Cables

Cable Overview 138

Cable Connections 139

Analog Output 140

Relay Output 141

Desktop PC Communications 144

Synchronization Signals 145

This chapter provides information on cables used with the instrument.



## Cable Overview

### Necessary cables

<b>p/n</b>	<b>Description</b>
392612901	Ethernet cable (for use in a <i>network</i> )
OR 5023-0203	Ethernet cable (cross-over, for <i>standalone</i> use)
392607969	Inject marker cable
392607975	Next injection cable
393546291	Serial communication ribbon
393597601	Converter RS-232 to RS-422
7910046300	Serial cable

### Optional cables

<b>p/n</b>	<b>Description</b>
110743800	Relay interface cable (for relay interface board, one relay contact per cable)
110744200	Analog signal cable

# Cable Connections

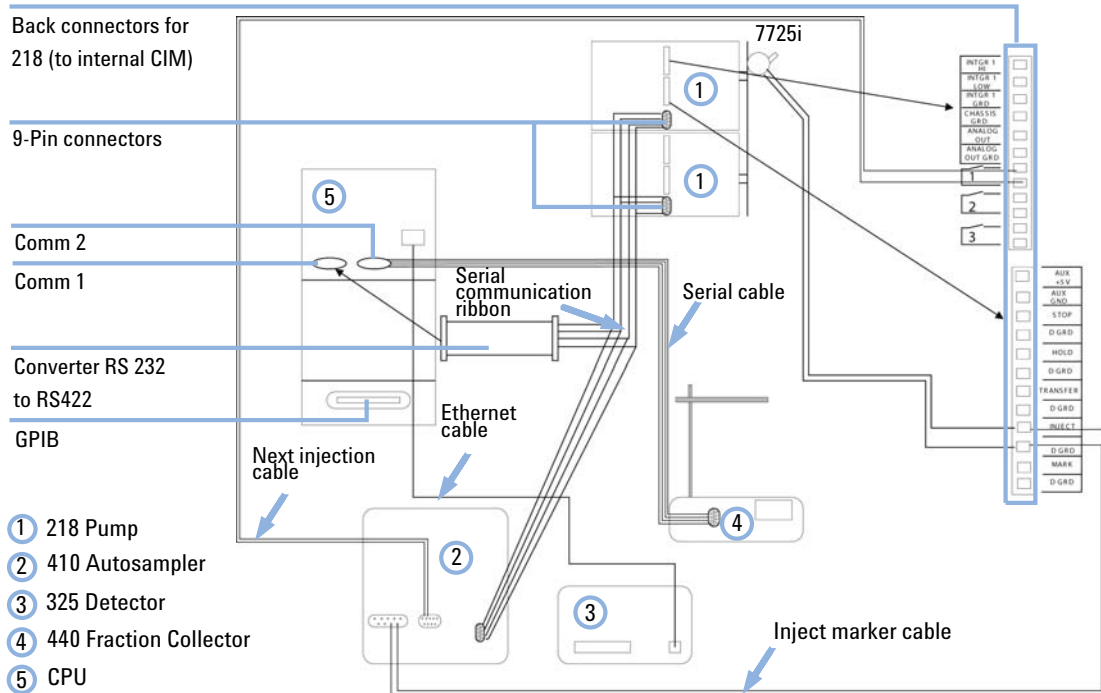

**Figure 25** Cable connections for workstation control of Agilent 218 Pumps, Agilent 325 Detector, Agilent 410 Autosampler and Agilent 440 Fraction Collector

## Analog Output

For analog output signals, install the optional Analog signal cable (110744200) into the J14 receptacle. Pin designations are shown below.

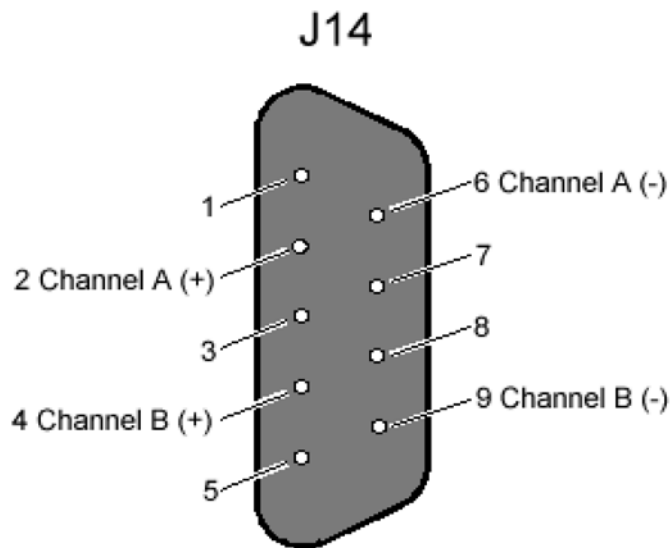
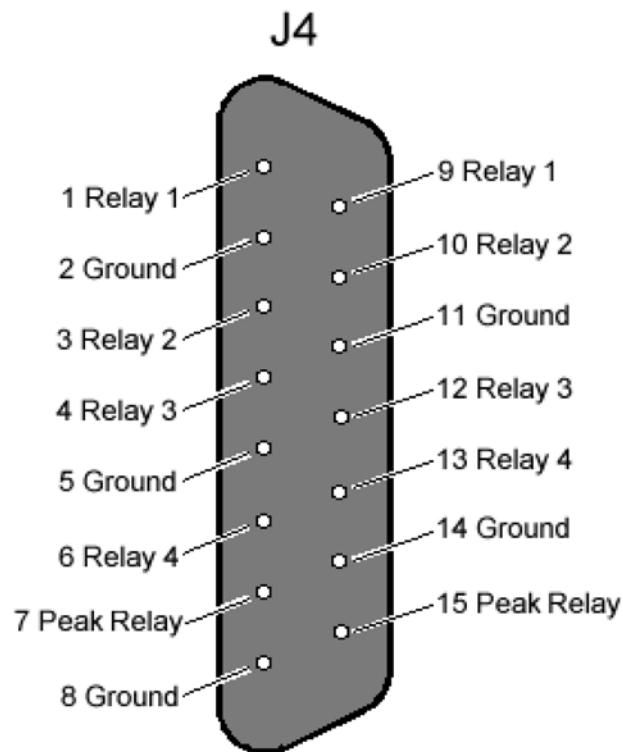

**Figure 26** Pin designation for J14

The open ends of the analog output cable have labels with the signal names (Channel A +, Channel A - and Channel B +, Channel B -).

## Relay Output

For time programming external events, a contact closure Relay output is available. To configure the Relay output, install the optional Assy PWB relay interface 325 (210187590) into the J4 receptacle. Pin designations are shown below.



**Figure 27** Pin designation for J4

There are four general purpose output relays and one dedicated Peak relay. Each output uses a DIP relay that is capable of handling 500 mA of contact current. At reset or power up, the output relay contacts are set to the default parameters (open). After loading a method they will be set as defined in the method's **time=0** parameters.

## 5 Cables

### Relay Output

The Peak relay is software programmable for duration, delay and active sense. At power up, the relay contact will be set to the inactive state (as defined by the value of the **active sense** parameter stored in the detector). Upon being triggered, relay activation will occur for the time interval equal to the **Peak Sense duration** parameter as stored in the method.

The Peak relay can be activated from any of the following sources (only one source can be active at any one time):

- Time Slice event – Once time slice has been turned on, it will provide a periodic activation of the Peak Sense relay at an interval defined in **Time Slice period** within the method. Time Slice can be turned on and off by time.
- Pulse event – A single timed programmed activation of the Peak Sense relay as defined in the method.
- Peak sense has been turned on.

To connect open-ended wires to the relay signals available at J4, use the optional Assy PWB relay interface 325 (210187590) (see [Figure 28](#) on page 142). Simply plug this PWB into the rear panel connector.

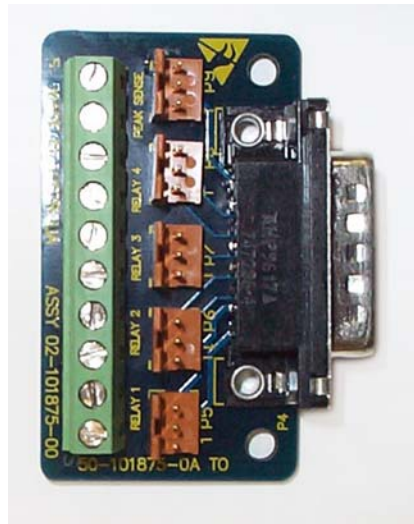

**Figure 28** Relay output board

The Relay interface cable (for relay interface board, one relay contact per cable) (110743800) is used to attach to the 3 pin connectors at the relay output board.

With the 3 pin connectors, the contact closure is between pins 1 and 2 of the plugs. Pin 3 is connected to ground. The relay interface cable has three open-ended wires. The relay contact is connected between the clear and the black wire. The green wire is connected to ground.

## Desktop PC Communications

Communication between the detector and a desktop PC occurs by an Ethernet connection. Communication by an Ethernet connection is required to control the detector remotely by OpenLAB. When the Workstation provides HPLC system control, the synchronization cables from P9 and J10 are not used.

To create an Ethernet connection, insert an RJ45 cable included in the ship kit into the J1 receptacle and into the PC. The Ethernet cable that comes with the detector is a cross-over cable, which is appropriate for connecting the detector directly to a PC. Connecting the detector to a network or a hub will usually require a patch cable. A Ethernet cable (for use in a network) (392612901) can be purchased from Agilent or either locally.

Most PCs come pre-configured with an Ethernet connection, which is usually built into the motherboard, or with an Ethernet network card installed. However, if you have a PC that has no network interface, you will need to install and configure a Network Interface Card (PCI bus). The PC must have a spare PCI slot for the installation of this device. You are also responsible for setting up and maintaining any LAN configuration where a detector may be used. All network issues are to be dealt with by the user.



## Synchronization Signals

The synchronization signals at P9 and J10 are used to synchronize the operation of a group of instruments that are not interfaced to OpenLAB. The synchronization signals come in four pairs and define how the detector will operate in a HPLC system. These signals are important for controlling timing and synchronization of the detector with the other devices in the system. Synchronization signals are closely tied to the detector states and transitions. P9 and J10 pin designations are shown in [Figure 29](#) on page 145.

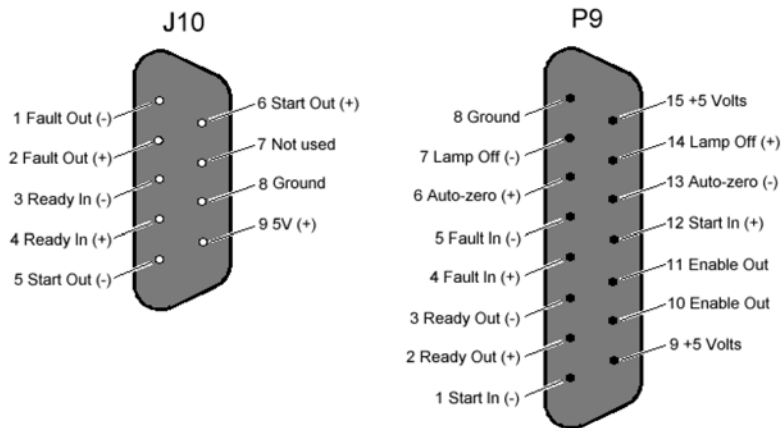

**Figure 29** Pin designations for J10 and P9

P9 provides connections when the Agilent 325 UV/VIS Dual Wavelength Detector acts as a “slave” and receives control from another module. J10 provides connections when the detector acts as a “master” and sends control to another device.

An input is activated or said to be present when its two signal wires are connected together. This can be done with a relay contact closure. If the inputs are driven from another instrument with optical isolators or other polarized devices, then attention must be paid to the polarity of the signal wire connections. The positive (+) output signal must be connected to the positive (+) input signal and the negative (-) output to the negative (-) input.

## 5 Cables

### Synchronization Signals

The color coding and physical design of the cable connectors ensure that correct signals and polarity are matched.

The outputs are optical isolators and simulate a relay contact closure when they are activated (see [Figure 30](#) on page 146). The minimum requirement for an input signal to be detected is 200 ms.

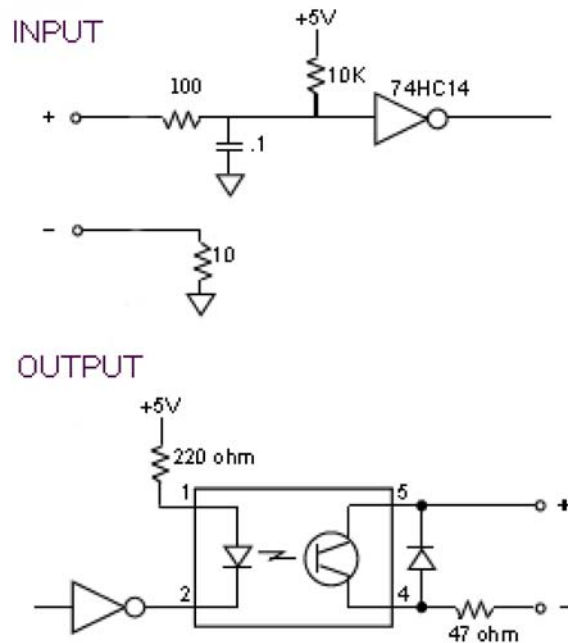

**Figure 30** Input/output schematics

**Table 9** Signal Description J10 and P9

Signal	Description
Enable Out	A non-polarized constantly active output (a short). This output can be used to activate Enable In on the next instrument.
Ready In	When Enable Ready In is set (software switch), this polarized input signal must be present before the Agilent 325 Detector can go to the Ready state. Specifically, when the Agilent 325 Detector is in the NOT Ready Lamp On state, on receiving a Ready In signal, a monitor period will occur after which the Agilent 325 Detector goes to the Ready state. It must stay active until the Agilent 325 Detector starts. Ready In will be ignored in all other states.
Ready Out	This polarized output signal indicates that the Agilent 325 Detector is in the Ready state and is ready to start a time program.
Start In	This polarized edge triggered input signal will start the active method if the Agilent 325 Detector is in the Ready state.
Start Out	This polarized output signal will be activated for 600 ms when the Agilent 325 Detector starts a time program.
Fault In	This polarized edge triggered input signal informs the Agilent 325 Detector that a fault condition exists in another instrument in the system. The Agilent 325 Detector halts the time program and sends a Fault Out signal. The lamp can be programmed to either remain on or turn off upon receiving a fault signal.
Fault Out	This polarized output signal will activate for 600 ms when either of the following conditions occurs: <ul style="list-style-type: none"> <li>• The Agilent 325 Detector discovers an internal fault condition that warrants aborting the run.</li> <li>• The Agilent 325 Detector receives a Fault In signal and it has no internal fault condition itself.</li> </ul>
Auto-zero	This edge-triggered contact closure causes an auto-zero adjustment.
Lamp off	This edge-triggered contact closure switches the lamp off. It is possible to turn the lamp back on manually if the contact is still closed.

An optional Assy PWB sync. interface 325 (210186590) is available to interface between the Agilent 325 UV/VIS Dual Wavelength Detector synchronization signals and other devices. This board is inserted into the P9 and J10 connectors and connects to a terminal strip on the adapter board. This terminal strip accepts bare wire leads from cables connecting other devices. These cables may originate from the other device, or a dedicated cable can be used, if available for the particular application.

## 5 Cables

### Synchronization Signals

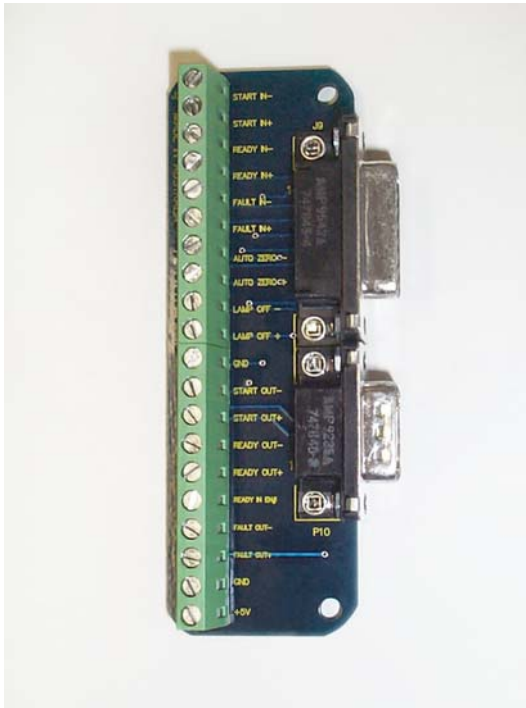

**Figure 31** The I/O adapter board



## 6 Appendix

General Safety Information	150
Solvent Miscibility	156
Solvent Compressibility	157
The Waste Electrical and Electronic Equipment Directive	159
Batteries Information	160
Radio Interference	161
Electromagnetic Compatibility	162
Agilent Technologies on Internet	164

This chapter provides addition information on safety, legal and web.



## General Safety Information

### General Safety Information

The following general safety precautions must be observed during all phases of operation, service, and repair of this instrument. Failure to comply with these precautions or with specific warnings elsewhere in this manual violates safety standards of design, manufacture, and intended use of the instrument. Agilent Technologies assumes no liability for the customer's failure to comply with these requirements.

#### **WARNING**

**Ensure the proper usage of the equipment.**

**The protection provided by the equipment may be impaired.**

→ The operator of this instrument is advised to use the equipment in a manner as specified in this manual.



---

## Information Symbols

The following is a list of symbols that appear with warnings in this manual or on the liquid chromatograph. The hazard they describe is also shown.

A triangular symbol indicates a warning. The meanings of the symbols that may appear alongside warnings in the documentation or on the instrument itself are as follows:

**Table 10** Warning symbols





		
Broken glass	Chemical hazard	Electrical shock
		
Explosion hazard	Eye hazard	Fire hazard
		
Heavy weight (danger to feet)	Heavy weight (danger to hands)	Hot surface
		
Moving parts	Respiratory hazard	Attention <sup>1</sup>

<sup>1</sup> The symbol may be used on warning labels attached to the instrument. When you see this symbol, refer to the relevant operation or service manual for the correct procedure referred to by that warning label.

## 6 Appendix

### General Safety Information

**Table 11** Information symbols

Symbol	Description
I	Mains power on
o	Mains power off
	Fuse
	Single phase alternating current
	Direct current
	Confirms that the product complies with the requirements of all applicable European Community directives



## Solvent Hazards

**WARNING**

**Explosion, fire, asphyxiation**

**This instrument is not explosion-proof.**

**Certain solvents may cause weakening and leaks of tubings or fittings with possible bursting.**

**Even small leaks in solvent supply systems can be dangerous.**

- Only use solvents compatible with the HPLC system tubings and fittings.
  - Employ static measuring and static discharge devices to safeguard against the buildup of static electricity.
  - In unattended operation, do not use organic solvents having an ignition point below 70 °C.
  - Do not bring a heat or flame source near the instrument.
  - The area in which solvents are stored and the area surrounding the instrument must be adequately ventilated to prevent accumulations of gas.
  - Always check the condition of the instrument (leakage of solvent or waste solution, leakage of solvent inside the instrument). If an abnormality is found, stop operation immediately.
  - When using flammable chemicals, be careful about possible ignition due to static electricity. To prevent the build-up of static electricity, use a conductive container for waste.
  - Use only approved regulator and hose connectors (refer to the supplier's instructions).
  - Keep solvents cool and properly labeled. Ensure that you have the correct solvent before connecting it to the instrument.
-

**WARNING**

**Inflammation or injury due to toxic, corrosive or stimulative solvent**

- Do not contact toxic, corrosive or stimulative solvent.
  - For details of the properties of each solvent and how to handle it, refer to the relevant Material Safety Data Sheets (MSDS).
  - Be sure to handle each solvent properly.
  - Wear proper personal protective clothes (e.g., safety goggles) so that a solvent will not come into direct contact with the skin.
  - Ventilate the laboratory room adequately to prevent accidental inhalation of harmful solvent vapor.
- 

**WARNING**

**Cuts**

- When working with glass or quartz parts take care to prevent breakage.
- 

**Other Precautions**

Airflow to the cooling fans of the liquid chromatograph must be unobstructed. Do not block the ventilation grills on the liquid chromatograph and accessories.

Consult the manuals supplied with your PC, monitor and for their specific ventilation requirements.

## High Pressure Hazards

### WARNING

**High velocity stream of volatile and/or toxic liquids.**

**If a line ruptures, a relief device opens, or a valve opens accidentally under pressure, potentially hazardous high liquid pressures can be generated by the pump.**

- Wear personal protective equipment when you inject samples or perform routine maintenance.
  - Never open a solvent line or valve under pressure. Stop the pump first and let the pressure drop to zero.
  - Always keep the doors and covers closed during operation.
  - Read and adhere to all Notes, Cautions, and Warnings in the manual.
- 

## Ultraviolet Radiation

### WARNING

**Irritation to the skin, eyes and upper respiratory system**

- Ensure that protective lamp covers of variable and fixed wavelength detectors are in place during operation.
  - Do not look directly into detector fluid cells or at the UV light source. When inspecting the light source or fluid cell, always use protective eye covering such as borosilicate glass or polystyrene.
  - Ventilate the area surrounding the detector such that the concentration of ozone does not exceed the maximum permissible level. All venting must be to outside air, never within the building.
- 

### Ozon generation

Ozone can be generated by radiation from the source lamps. The maximum permissible exposure level is 0.1 ppm (0.2 mg/m<sup>3</sup>).



## Solvent Compressibility

The values in [Table 12](#) on page 157 should be used for the Agilent 218 Purification Solution compressibility factors when you are setting up the pumping system parameters.

For details on how to set up the pump system parameters, refer to Agilent 218 Solvent Delivery Module - User Manual (G9300-90001).

**Table 12** Compressibility factors

<b>Solvent</b>	<b>x</b>	<b>L</b>
Water	46	3231
Acetone	128.9	956
Acetonitrile	97.4	1212
Benzene	96.7	1046
Carbon tetrachloride	106.7	998
Chloroform	97.4	1227
Cyclohexane	114	800
Dichloroethane	111.9	1020
Diethyl ether	188	700
Dimethylformamide	80	1500
Dioxane	60	1500
Ethanol	115	1100
Ethyl acetate	100	1800
Methylene chloride	97.4	1212
Methanol	125	1200
n Heptane	144	760
n Hexane	167.2	644
o Dichlorobenzene	95	1400

## 6 Appendix

### Solvent Compressibility

**Table 12** Compressibility factors

<b>Solvent</b>	<b>x</b>	<b>L</b>
Propanol	98	1200
Tetrahydrofuran	95	1500
Toluene	93	1200
2-Methylformamide	80	1500

# The Waste Electrical and Electronic Equipment Directive

## Abstract

The Waste Electrical and Electronic Equipment (WEEE) Directive (2002/96/EC), adopted by EU Commission on 13 February 2003, is introducing producer responsibility on all electric and electronic appliances starting with 13 August 2005.

### NOTE

This product complies with the WEEE Directive (2002/96/EC) marking requirements. The affixed label indicates that you must not discard this electrical/electronic product in domestic household waste.

Product Category:

With reference to the equipment types in the WEEE Directive Annex I, this product is classed as a Monitoring and Control Instrumentation product.

---



### NOTE

Do not dispose off in domestic household waste

To return unwanted products, contact your local Agilent office, or see [www.agilent.com](http://www.agilent.com) for more information.

---

## Batteries Information

### WARNING

Lithium batteries may not be disposed-off into the domestic waste. Transportation of discharged Lithium batteries through carriers regulated by IATA/ICAO, ADR, RID, IMDG is not allowed.

**Danger of explosion if battery is incorrectly replaced.**

- Discharged Lithium batteries shall be disposed off locally according to national waste disposal regulations for batteries.
  - Replace only with the same or equivalent type recommended by the equipment manufacturer.
- 



### WARNING

**Lithiumbatteri - Eksplosionsfare ved fejlagtig håndtering.**

**Udskiftning må kun ske med batteri af samme fabrikat og type.**

- Lever det brugte batteri tilbage til leverandøren.
- 

### WARNING

**Lithiumbatteri - Eksplosionsfare.**

**Ved udskiftning benyttes kun batteri som anbefalt av apparatfabrikanten.**

- Brukt batteri returneres apparatleverandøren.
- 

### NOTE

Bij dit apparaat zijn batterijen geleverd. Wanneer deze leeg zijn, moet u ze niet weggooien maar inleveren als KCA.

---



## Radio Interference

Cables supplied by Agilent Technologies are screened to provide optimized protection against radio interference. All cables are in compliance with safety or EMC regulations.

### Test and Measurement

If test and measurement equipment is operated with unscreened cables, or used for measurements on open set-ups, the user has to assure that under operating conditions the radio interference limits are still met within the premises.

## Electromagnetic Compatibility

### EN55011/CISPR11

Group 1 ISM equipment: group 1 contains all ISM equipment in which there is intentionally generated and/or used conductively coupled radio- frequency energy which is necessary for the internal functioning of the equipment itself.

Class A equipment is equipment suitable for use in all establishments other than domestic and those directly connected to a low voltage power supply network which supplies buildings used for domestic purposes.

This device complies with the requirements of CISPR11, Group 1, Class A as radiation professional equipment. Therefore, there may be potential difficulties in ensuring electromagnetic compatibility in other environments, due to conducted as well as radiated disturbances.

Operation is subject to the following two conditions:

- This device may not cause harmful interference.
- This device must accept any interference received, including interference that may cause undesired operation.

If this equipment does cause harmful interference to radio or television reception, which can be determined by turning the equipment off and on, the user is encouraged to try one or more of the following measures:

- Relocate the radio or antenna.
- Move the device away from the radio or television.
- Plug the device into a different electrical outlet, so that the device and the radio or television are on separate electrical circuits.
- Make sure that all peripheral devices are also certified.
- Make sure that appropriate cables are used to connect the device to peripheral equipment.
- Consult your equipment dealer, Agilent Technologies, or an experienced technician for assistance.
- Changes or modifications not expressly approved by Agilent Technologies could void the user's authority to operate the equipment.

## **ICES/NMB-001**

This ISM device complies with Canadian ICES- 001.

Cet appareil ISM est conforme à la norme NMB-001 du Canada.

## **Agilent Technologies on Internet**

For the latest information on products and services visit our worldwide web site on the Internet at:

<http://www.agilent.com>

# Index

## 3

3-way pump head prime valve  
installation 52

## A

AC power 73  
Agilent  
on internet 164  
analog output 140  
assembling  
fraction collector 96  
autosampler  
connecting 92  
lifting 34  
location 84  
service 13

## B

battery  
safety information 160

## C

cables  
other 72  
power 72  
checklist  
delivery 29  
pump 29  
column oven 13  
communication cabling  
connecting 66  
components 95  
condensation 20  
connections

workstation control 139

connector  
external contacts 67  
connectors  
external 67

## D

defect on arrival 28  
delivery checklist  
autosampler 30  
capillary kits 31  
detector 29  
fraction collector 30  
delivery 26  
detector outlet back pressure  
restrictor 81  
driver  
installation 115

## E

electronic waste 159

## F

features 11  
flowcell types 76  
flowcell  
install 77

## G

general waste tubing  
connecting 88

## H

hardware  
setup 110  
high pressure tubing  
pump head 58  
high pressure  
hazard 155

## I

inlet filter assembly 56  
inspection 32  
installation  
internal mixer 45  
mast kit 47  
overview 96  
pressure module 43  
probe 98  
pump head 41  
tubing 98  
installing  
door 82  
internal mixer  
installation 45  
internet 164  
introduction  
autosampler 12  
detector 11  
fraction collector 15  
preparative autosampler 14  
system 8

## L

lithium batteries 160  
location

## Index

- detector module 71
- low pressure tubing 56
- M**
- maintenance
  - module 136
- manual injection valve and bracket
  - installation 49
- mast kit
  - installation 47
- mat
  - rack location 98
- method
  - setup 124
- O**
- outlet check valve
  - connections 59
- overview
  - installation 96
  - module 85
- P**
- packaging
  - damaged 28
- parts 136
- piston-washing
  - installation 57
- plumbing fittings
  - analytical stainless steel 63
  - analytical titanium mixers 64
  - narrowbore titanium 64
  - narrowbore 63
  - preparative PEEK 65
  - preparative titanium 65
- plumbing
  - safety 55
- power cords 19
- power
  - connection 104
- prep option
  - installing 94
- pressure module
  - installation 43
- prime/purge valve and bracket
  - installation 51
- pump head high pressure tubing
  - installation 58
- pump head
  - installation 41
  - setting, control software 69
- pump ID
  - setting, control software 69
- pump
  - overview 9
- R**
- rack location
  - mat 98
- rack
  - orientation 103
- radio interference 161
- reagente addition 13
- relay output 141
- removing
  - door 83
  - front panel 75
- S**
- safety information
  - lithium batteries 160
- safety
  - general information 150
- sample rack
  - assembly 101
  - installation 102
- sample tray
  - installation 93, 88
- setup
  - ChemStation control 116
  - electrical 39
  - hardware 110
  - OpenLab 116
  - pump ID 111
- side-port needle 12
- site requirements
  - power cords 19
- specifications 21
- spill tray
  - installation 97
- stack
  - auto-preparative 38
  - binary 37
  - isocratic 36
  - optimizing 35
- synchronization signals 145
- syringe waste tubing
  - connecting 89
- system
  - rinsing 91
- T**
- terminal strip
  - J2 68
  - J3 68
- troubleshooting 136
- U**
- unpacking 32
- using 136
- V**
- vials
  - filling and sealing 92
- W**
- waste

electrical and electronic  
equipment 159

water and leakage drain  
connecting 89

WEEE directive 159

[www.agilent.com](http://www.agilent.com)

## In This Book

This manual provides setup information on following modules:

- Agilent 218 Solvent Delivery Module (G9300A/G9301A)
- Agilent 325 UV/VIS Dual WL Detector (G9309A)
- Agilent 410 Autosampler (G9331A/G9332A)
- Agilent 440 Fraction Collector (G9340A)

The manual describes the following:

- Optimizing stack configuration
- Setup hardware
- Setup software
- Setup methods

© Agilent Technologies 2012, 2013

Printed in Germany  
03/2013



G9300-90301