

Agilent 1260 Infinity Fraction Collector Delay Volumes and Delay Calibration

Technical Note

Technical Information for the use of Fraction Collectors about Delay Volumes and Delay Calibration.

Contents

Introduction to Delay Volumes and Delay Calibration for Fraction Collection 2

Detector Signal Delay 5

Delay Time and Volume Calibration of Fraction Collector for UV (Lab Advisor) and MSD Signals 8

Performing a Delay Calibration with an UV Detector 8

Performing a Delay Calibration with an Additional Detector 14

Performing a Delay Calibration with an MSD 20

Tips and Tricks 23

Insufficient UV to FC delay volume 23

Insufficient MSD to FC delay time 24



Introduction to Delay Volumes and Delay Calibration for Fraction Collection

NOTE

This section describes the standard Delay Volume Calibration procedure with Agilent Lab Advisor software, Rev. B.02.04 or higher.

If you are running your *preparative-scale* fraction collector as a component of the Agilent 1260 Infinity Purification Solution with Automated Purification Software, follow the specific flavor of this procedure as described in the Purification Solution's documentation.

The delay calibration procedure determines the delay time between the detector and the fraction collector in the system. The delay time is used to compensate the time a compound needs to travel between the point of detection in the detector and the point of collection in the fraction collector.

This delay is a system parameter which depends on the installed fraction collector tubing (t_{D1}) and the fraction collector needle (t_{D2}). The delay volume corresponding of the delay t_{D2} is automatically taken in consideration on the different types of fraction collectors:

- Analytical scale fraction collector: approximately 23 μL
- Preparative scale fraction collector: approximately 120 μL

With the Agilent 1260 Infinity Fraction Collector, the delay calibration procedure is performed using the flow delay sensor (FDS), a very simple detector built into the fraction collector. Together with the signal from the detector, the signal from the FDS facilitates determination of the delay time between detector and fraction collector as shown in [Figure 1](#) on page 2.

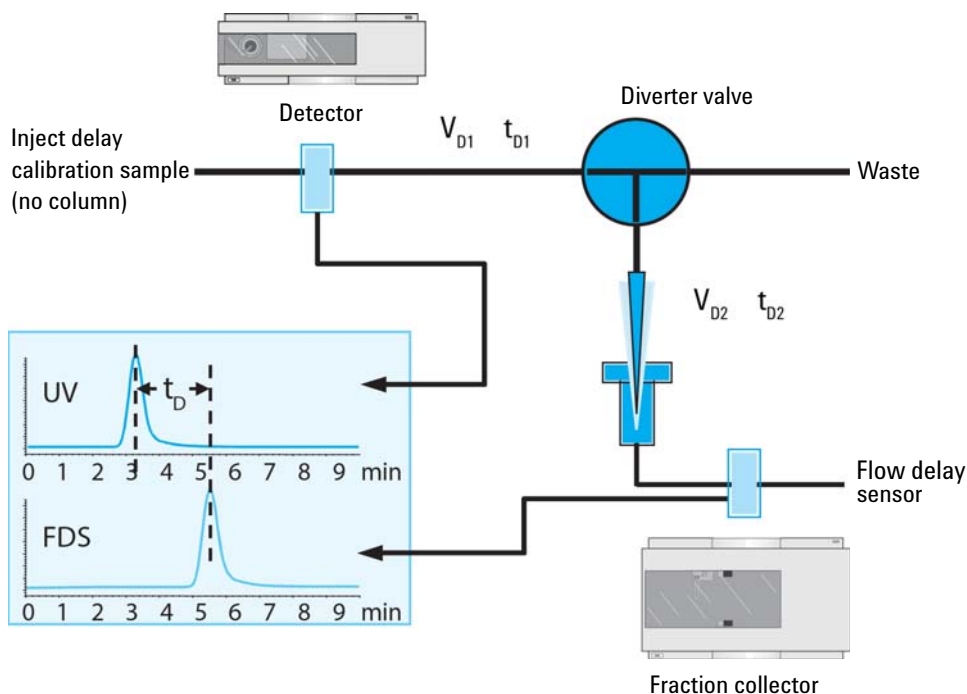

Figure 1 Scheme of the delay volume between UV detector and fraction collection

Delay Volume with a Detector After the Splitter

In the case the detector is placed after a flow splitter, the resulting volume does not represent a real tubing volume between the UV detector and fraction collector, but a virtual delay volume. Two cases can be distinguished:

- In the case of the Agilent Splitter Kits, the resulting volume measured during the delay calibration is compatible with other flow rates. And the delay volume will be converted in a correct delay time between detector and fraction collector.

Examples with the Agilent Splitter Kit #5023-2258:

- Method 1:

Prep flow path: Capillary volume of 2.69 mL with a flow rate of 50 mL/min. The time a compound needs to reach the fraction collector is 3 seconds

Split flow path: Capillary volume of 7.5 μ L with a flow rate of 0.5 mL/min. The time a compound needs to reach the fraction collector is 1 second.

The delay time is 2 seconds, corresponding to a delay volume of 1.67 mL.

- Method 2:

Prep flow path: Capillary volume of 2.69 mL with a flow rate of 25 mL/min. The time a compound needs to reach the fraction collector is 6 seconds.

Split flow path: Capillary volume of 7.5 μ L with a flow rate of 0.25 mL/min. The time a compound needs to reach the fraction collector is 2 seconds.

The delay time is 4 seconds, corresponding to a delay volume of 1.67 mL.

For the Agilent Splitter kits, the delay volume measured for one flow rate is compatible with any other preparative flow rates.

- In the particular case of an active splitter or a passive splitter combined with a make-up pump, the delay calibration must be performed using the preparative and make-up flows, which will be used for the preparative method. If one of flows is changed (or if a HPLC capillary after the UV detector is changed), then the resulting delays cannot be simply recalculated to a new condition. The delay calibration needs to be measured for the new combination of flow rates.

Examples with the Active Splitter G1968D:

- Method 1:

Prep flow path: Capillary volume of 2.69 mL with a flow rate of 50 mL/min. The time a compound needs to reach the fraction collector is 3 seconds.

Split flow path: Capillary volume of 7.5 μ L with a flow rate of 1 mL/min. The time a compound needs to reach the fraction collector is 0.5 seconds.

The delay time is 2.5 seconds, corresponding to a delay volume of 2.08 mL.

- Method 2:

Prep flow path: Capillary volume of 2.69 mL with a flow rate of 25 mL/min. The time a compound needs to reach the fraction collector is 6 seconds.

Split flow path: Capillary volume of 7.5 μ L with a flow rate of 1 mL/min. The time a compound needs to reach the fraction collector is 0.5 seconds.

The delay time is 7 seconds, corresponding to a delay volume of 2.94 mL.

With a make-up flow splitter, the measured delay volume in lab Advisor cannot be simply used for any other flow rates.

NOTE

There are combinations of main and make-up flows that cannot be used. If in the same example as above, the main flow used is 60 mL/min (5 s splitter to FC delay) and the make-up flow is 0.5 mL/min (6 s splitter to detector delay), the resulting delay time and volume become negative.

Delay Volume with an Additional Detector

Despite the Mass Spectrometers detectors, for additional detectors, the delay calibration procedure is similar. To each detector, corresponds one delay volume. The delay calibration procedure can be performed from any detector connected to a UIB. The signal collected by the UIB will be then used for the delay calibration.

Peak Triggering in Consideration of the Delay Volume

After correct completion of the delay volume calibration, when a peak is detected during a purification run (see Figure 2 on page 4) the diverter valve is triggered using the following delay time calculations:

Start of fraction collection: $t = t_0 + t_{D1}$

End of fraction collection: $t = t_E + t_{D1} + t_{D2}$

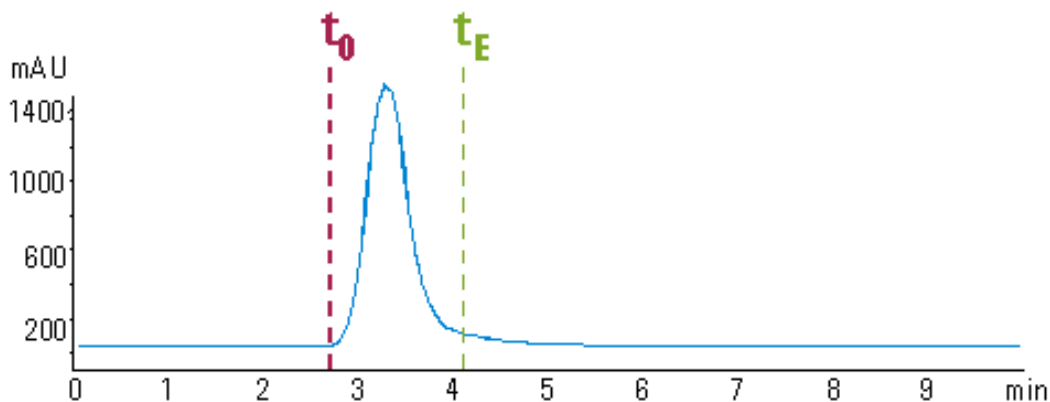

Figure 2 Chromatogram from a UV-detector with peak starting at t_0 and ending at t_E

t_{D1} is the delay time corresponding to the delay volume measured during the delay calibration.

Detector Signal Delay

Every Agilent 1260 Infinity detector that is used for triggering fractions has an internal signal delay caused by filtering the raw data. The signal delay depends on the **Peakwidth** setting of the detector and is accounted for when the diverter valve is triggered. [Table 1](#) on page 5 to [Table 5](#) on page 6 list the internal signal delay times for different **Peakwidth** settings.

Table 1 Signal Delay Times for the Agilent 1260 Infinity DAD/MWD (G1315D; G4212B/G1365D)

Peakwidth (min)	Response time (sec)	Signal delay (sec)
<0.01	0.1	0.05
>0.01	0.2	0.15
>0.03	0.5	0.5
>0.05	1.0	1.25
>0.10	2.0	2.75
>0.20	4.0	5.9
>0.40	8.0	11.9
>0.85	16.0	23.9

Table 2 Signal Delay Times for the Agilent 1260 Infinity DAD/MWD SL (G1315C/G1365C)

Peakwidth (min)	Response time (sec)	Signal delay (sec)
<0.0025	0.02	0.0375
>0.0025	0.05	0.0625
>0.005	0.1	0.144
>0.01	0.2	0.294
>0.03	0.5	0.619
>0.05	1.0	1.27
>0.1	2.0	2.57
>0.2	4.0	5.17
>0.4	8.0	10.4
>0.85	16.0	20.8

Table 3 Signal Delay Times for the Agilent 1260 Infinity VWD G1314B

Peakwidth (min)	Response time (sec)	Signal delay (sec)
<0.005	<0.12	0.07
>0.005	0.12	0.14
>0.01	0.25	0.29
>0.025	0.5	0.58
0.05	1	1.3
0.1	2	2.8
0.2	4	6.0
0.4	8	12.3

Table 4 Signal Delay Times for the Agilent 1260 Infinity VWD SL G1314C

Peakwidth (min)	Response time (sec)	Signal delay (sec)
<0.00125	<0.02	0.0182
>0.00125	0.02	0.0364
>0.0025	0.05	0.0728
>0.005	0.12	0.146
>0.01	0.25	0.328
>0.025	0.5	0.710
>0.05	1	1.49
>0.1	2	3.08
>0.2	4	6.26
>0.4	8	12.6

Table 5 Signal Delay Times for the Agilent 1260 Infinity FLD G1321A

Peakwidth (min)	Response time (sec)	Signal delay (sec)
<0.005	<0.12	0.018
>0.005	0.12	0.073
>0.01	0.25	0.18
>0.03	0.5	0.44
>0.05	1	0.96
>0.1	2	2.0
>0.2	4	4.2
>0.4	8	8.6

CAUTION

Loss of data

If the internal signal delay is longer than the delay time t_{D1} some of the peak will be lost.

→ The maximum allowed signal delay time can be calculated using the following equation:

$$\text{Signal delay time}_{(max)} = \frac{V_{D1}}{\dot{v}} \quad \dot{v} = \text{Flow rate}$$

→ After calculating the maximum signal delay time a Peakwidth setting can be selected that gives a signal delay time, which is shorter than the calculated maximum signal delay time. This **Peakwidth** setting should then be used for the LC purification run.

NOTE

We recommend to set the **Peakwidth** always to > 0.01 for the DAD and MWD or to > 0.005 for the VWD.

If the **Peakwidth** setting cannot be reduced and the signal delay time is longer than t_{D1} it is also possible to increase V_{D1} by adding additional tubing. However this higher delay volume will increase the peak dispersion between detector and fraction collector.

Delay Time and Volume Calibration of Fraction Collector for UV (Lab Advisor) and MSD Signals

Performing a Delay Calibration with an UV Detector

The delay time calibration determines a delay of a signal between a fraction collector (FC) and a detector. In the UV to FC delay volume calibration the measured delay time (t_{delay}) is recalculated to a delay volume (V_{delay}) using a preparative flow (F): $V_{\text{delay}} = t_{\text{delay}} * F$.

In case the detector is placed after a flow splitter with a make-up pump, the delay volume is measured each time the combination of preparative and make-up flows or the make-up flow needs to be re-adjusted, see “[Delay Volume with a Detector After the Splitter](#)” on page 3.

The delay volume between the UV detector and the FC is determined using Agilent Lab Advisor software. A delay calibration mixture (p/n 5190-6887) is injected as a marker.

For the preparative Fraction collector, the delay calibration is performed using a column, and for the analytical fraction collector, a zero dead volume union is used.

Table 6 Recommendations for fraction collector delay calibration

Scale	Column	Flow rate	Injection volume
Analytical	Use the zero dead volume union instead of a column	1 – 5 mL/min	25 µL
Preparative	9.4 mm id	6 mL/min	25 µL
	21.2 mm id	25 mL/min	50 µL
	30 mm id	45 mL/min	75 µL

Parts required

p/n	Description
G1946-85020	Delay Sensor Calibrant Calibration time solution For delay calibration with analytical scale fraction collector
0100-0900	1/16 in union, zero dead volume, stainless steel For delay calibration with analytical scale fraction collector
5190-6887	Agilent Standard #2 (Delay time calibration solution for 1260 LC-MS) For delay calibration with preparative scale fraction collector
5190-5108	Regenerated cellulose filters, 15 mm diameter, 0.2 µm pore size For delay calibration with preparative scale fraction collector

Preparations

- Solvents:
- Solvent A: water with 0.1 % formic acid.
 - Solvent B: acetonitrile with 0.1 % formic acid.
 - In the case the UV detector is after splitter and a make-up pump is used:
Recommended make-up solvent: 80 % acetonitrile in water with 0.1 % formic acid .

Delay volume UV/FC calibration procedure:

- 1 Install a column (for UV/FC calibration at preparative scale).
OR
Install a zero dead volume union (for UV/FC calibration at analytical scale)
- 2 Start OpenLab CDS ChemStation and prepare instrument:
 - a Load a preparative method containing the system parameters desired and considered for the delay calibration. If a make-up pump is used, ensure the correct flow set.
 - b If using a column (for UV/FC calibration at analytical scale) purge the column with 70 % of solvent B using the recommended flow rate for 2 min.
 - c Switch the preparative or analytical pumps off after column equilibration (in order to save solvent)
- 3 Exit OpenLab CDS ChemStation
- 4 If using MSD, remove *remote start cable* from LC stack
- 5 Make sure that both standard outlet and Fraction Collector's flow delay sensor waste tubing of FC go to a waste container
- 6 Place at least 500 μ L of the corresponding delay calibration solution to 2 mL vial and place it in the sample tray – use single numbered vial positions on the tray (1, 2, ...)

NOTE

Filter Agilent Standard #2 (5190-6887) sample before use with Regenerated cellulose filters, 15 mm diameter, 0.2 μ m pore size (5190-5108).

- 7 Start Lab Advisor.
- 8 If a make-up pump is used, the flow can be checked on the Instrument Control and under Controls the make-up pump. The pump must be in operation (if not, click On)

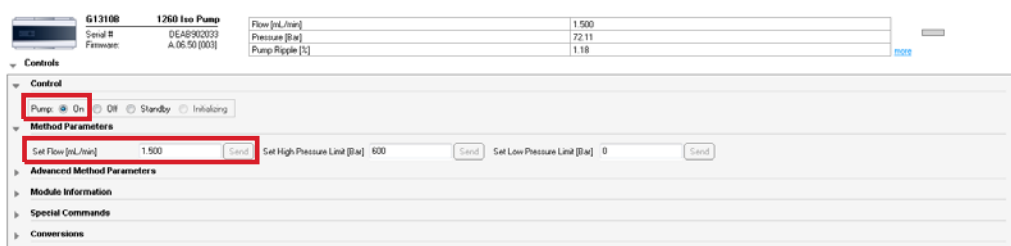

- 9 Go to **Service & Diagnostics**, select the target fraction collector (FC) and start **Delay Volume Calibration**.

NOTE

If more than one FC is used and if in the last working instrument configuration were fraction collectors clustered, perform the calibration only with the first clustered FC (the order of FCs in the FC cluster can be found in the instrument configuration in OpenLab Control Panel software). The clustered FC has one extra section **Clustering** in the **Delay Volume Calibration** window (see [Figure 3](#) on page 10). If FCs are clustered but not the first one FC is selected for the calibration (incorrect one), then the calibration window is the same as for FCs without clustering.

Delay Time and Volume Calibration of Fraction Collector for UV (Lab Advisor) and MSD Signals

Performing a Delay Calibration with an UV Detector

Delay volume calibration

Select the modules that should be used for this calibration run:

Hint
Ensure that there's no remote start cable connected to the LC.

Required Modules

Pump: G1361A [S/N DEAAF00625]

Detector: G1315C [S/N DEA0000003]

Injector: G2258A [S/N DEAAP00116]

Clustering

Selection Valve: G1170A [S/N DEBAD00433]

Pump

Flow rate: 31.9 ml/min Stoptime: 4 min

Composition: ...

Injector

Volume: 50 µl Sample loop: Upper

Vial position: 1

OK Cancel

Figure 3 Delay volume calibration of fraction collector in Lab Advisor: Clustered fraction collector with extra section **Clustering**.

Delay volume calibration

Select the modules that should be used for this calibration run:

Hint
Ensure that there's no remote start cable connected to the LC.

Required Modules

Pump: G1361A [S/N DEAAF00625]

Detector: G1315C [S/N DEA0000003]

Injector: G2258A [S/N DEAAP00116]

Pump

Flow rate: 31.9 ml/min Stoptime: 4 min

Composition: ...

Injector

Volume: 50 µl Sample loop: Upper

Vial position: 1

OK Cancel

Figure 4 Delay volume calibration of fraction collector in Lab Advisor: Window of non-clustered fraction collector.

10 In the Delay Volume Calibration window set following:

- **Required Modules:**
 - **Pump:** Choose the preparative pump, or the analytical pump used.
 - **Detector:** UV detector for calibration.

- **Injector:** Autosampler for calibration.
- **Clustering** (appears only for the first FC of the FC cluster):
 - **Selection Valve:** Select the valve that was clustered in the FC cluster (the serial number is labelled on the valve).
- **Pump:**
 - **Flow rate:** Set target flow of the main pump.
 - **Stoptime:** 4 min.
 - **Composition** (for G1361A pumps): Click on “...” button and set composition to 70 % of solvent B.
- **Injector:**
 - **Volume:** See [Table 6](#) on page 8.
 - **Sample Loop** (for G2258A dual-loop autosampler): Upper loop.
 - **Vial Position:** Enter position corresponding to the vial with the Agilent Standard #2 (5190-6887).
- If an Agilent *Active Splitter G1968D* is used:
 - If using Active Splitter Software (OpenLAB CDS Chemstation installation disk 6):
 - Set the Agilent Active Splitter to **Remote** (button on the front side of the splitter).
 - Start (and configure) Active Splitter Software.
 - In software enter the target main pump flow and set a split ratio (typically around 1:1000).
 - Start the splitter.

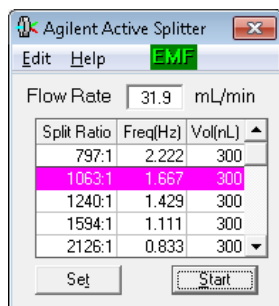

- Otherwise perform manual setup (see *MRA Operating Manual* which you can find e.g. on the *Agilent Purification & Preparative LC User Documentation DVD*):
 - Set Agilent Active Splitter to **Local**.
 - Use Split Factor table on page 5 and Calculating split ratio equation on page 6 of the *MRA Operating Manual* to set the target split ratio (typically 1:1000).
 - Start the splitter (to start or stop the splitter press simultaneously both **SET** and **↑** buttons).
- Click **OK** button to start calibration.

Delay Time and Volume Calibration of Fraction Collector for UV (Lab Advisor) and MSD Signals
Performing a Delay Calibration with an UV Detector

- 11 During initialization, which can take several minutes, the FC arm moves forward and the procedure asks to install the FDS adapter and close the FC door.

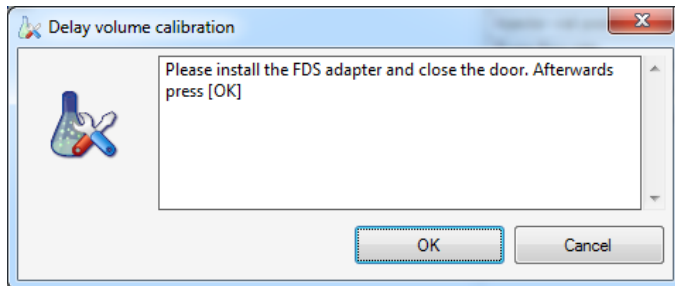

- 12 After the sample is injected it is possible to click on **Signals** tab to see UV detector and delay sensor signals.

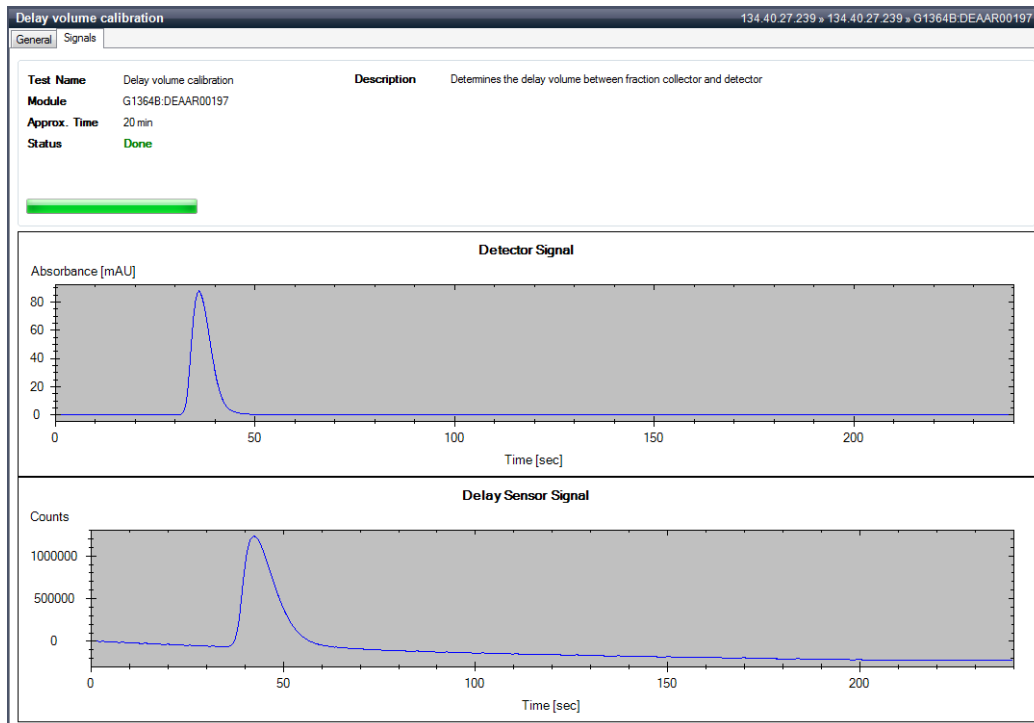

- 13 The results are displayed after completion.

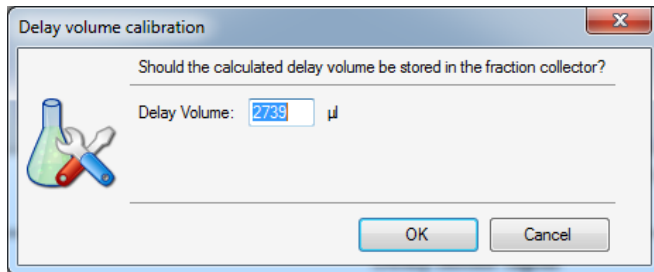

NOTE

Keep a record of this delay volume, for further use in Automated Purification Software for example.

- 14 After the end of calibration, the procedure offers to stop main flow (recommended), switch off UV lamp and remove the FDS adapter.

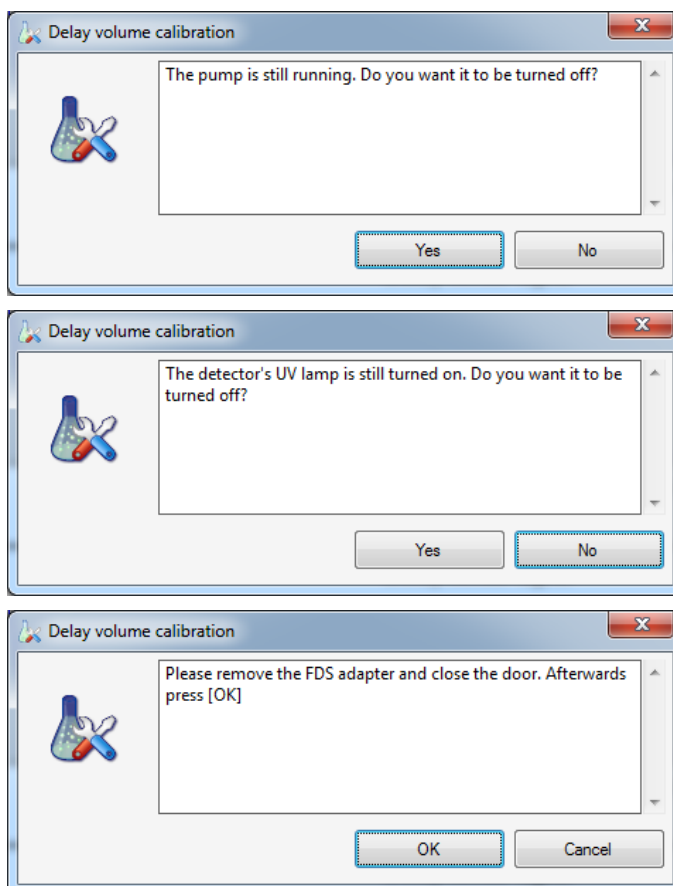

- 15 Connect back the remote start cable to LC stack (if used).
- 16 Stop the splitter, go to **Instrument Control**, and stop the make-up pump.
- 17 The delay volume must be positive otherwise the calibration is invalid. In such a case see “[Insufficient UV to FC delay volume](#)” on page 23 or “[Insufficient MSD to FC delay time](#)” on page 24.
- 18 The delay volume is written to the FC firmware and the value is coupled with the used UV detector and will be used for fraction collection. To check or change the value, go to **Service & Diagnostics > select FC > Delay Volume Tool**.
- 19 If applicable, set the same delay volumes for other fraction collectors by **Service & Diagnostics > select the other FCs > Delay Volume Tool**. In case of different lengths of capillaries between the FC and UV detector execute Delay Volume Calibration for each FC in order to calibrate them individually but if FC clustering is used, remove it first from the instrument configuration.

Performing a Delay Calibration with an Additional Detector

For theory of delay calibration, see “Performing a Delay Calibration with an UV Detector” on page 8.

Parts required	p/n	Description
	5190-6886	Agilent Standard #1 (Spec out solution for 1260 LC-MS)
	5190-6887	Agilent Standard #2 (Delay time calibration solution for 1260 LC-MS)
	5190-5084	PTFE syringe filter, 0.2 µL, 15 mm

Performing a Delay Calibration with an Additional Detector

- 1 Connect the additional detector (ELSD, RID, FLD, ...) to an Universal Interface Box (UIB) (G1390B)
- 2 Install a preparative column (recommended SB-C18 21.2 x 50 mm, 5 µm or 21.2 x 150 mm, 5 µm)
- 3 Start OpenLab CDS ChemStation and prepare instrument:
 - a Load a preparative method containing the system parameters desired and considered for the delay calibration. If a make-up pump is used, ensure the correct flow set.
 - b Purge th column with 70 % of solvent B using 30 mL/min for 2 min.
 - c Switch the preparative pumps off after column equilibration (in order to save solvent).
- 4 Exit OpenLab CDS ChemStation
- 5 If using MSD, remove *remote start cable* from LC stack
- 6 Make sure that both standard outlet and Fraction Collector's flow delay sensor waste tubing of FC go to a waste container
- 7 Place at least 500 µL of Agilent Standard #2 (5190-6887) to a 2 mL vial and place it in the sample tray - use single numbered vial positions on the tray (1, 2, ...)

NOTE

Filter Agilent Standard #2 (5190-6887) sample before use with PTFE syringe filter, 0.2 µL, 15 mm (5190-5084).

- 8 Start Lab Advisor.

Delay Time and Volume Calibration of Fraction Collector for UV (Lab Advisor) and MSD Signals

Performing a Delay Calibration with an Additional Detector

- 9 If a make-up pump is used, the flow can be checked on the Instrument Control and under Controls the make-up pump. The pump must be in operation (if not, click On)

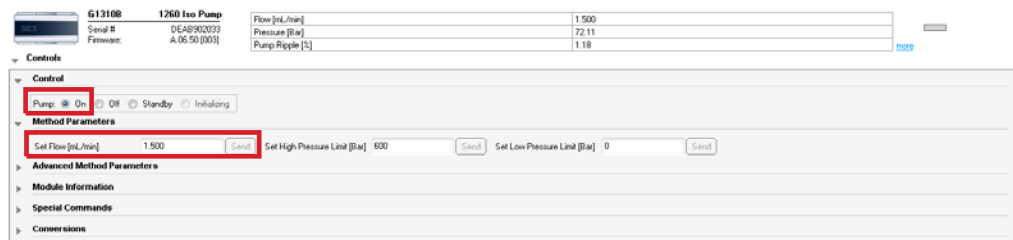

- 10 Go to **Service & Diagnostics**, select the target fraction collector (FC) and start **Delay Volume Calibration**.

NOTE

If more than one FC is used and if in the last working instrument configuration were fraction collectors clustered, perform the calibration only with the first clustered FC (the order of FCs in the FC cluster can be found in the instrument configuration in OpenLab Control Panel software). The clustered FC has one extra section **Clustering** in the **Delay Volume Calibration** window (see [Figure 5](#) on page 15). If FCs are clustered but not the first one FC is selected for the calibration (incorrect one), then the calibration window is the same as for FCs without clustering.

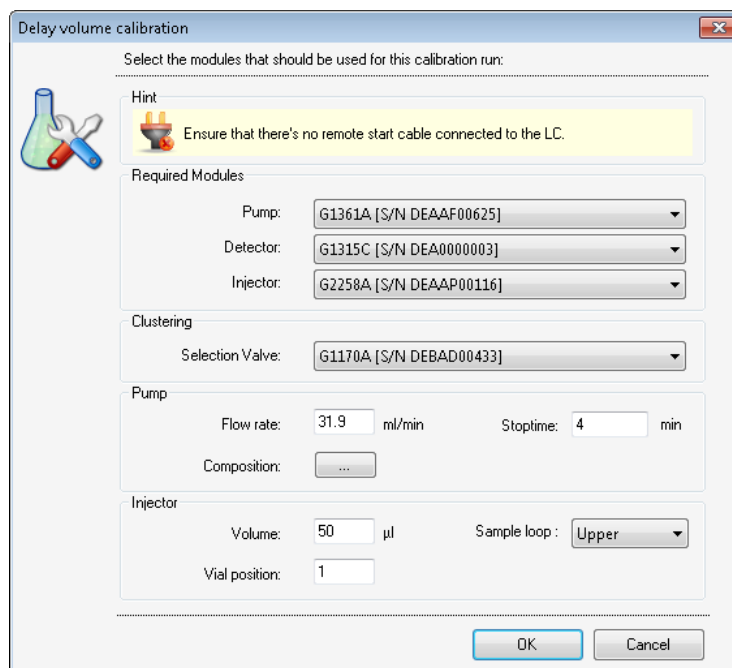

Figure 5 Delay volume calibration of fraction collector in Lab Advisor: Clustered fraction collector with extra section **Clustering**.

Delay Time and Volume Calibration of Fraction Collector for UV (Lab Advisor) and MSD Signals Performing a Delay Calibration with an Additional Detector

Delay volume calibration

Select the modules that should be used for this calibration run:

Hint
Ensure that there's no remote start cable connected to the LC.

Required Modules

Pump: G1361A [S/N DEAAF00625]

Detector: G1315C [S/N DEA0000003]

Injector: G2258A [S/N DEAAP00116]

Pump

Flow rate: 31.9 ml/min Stoptime: 4 min

Composition: ...

Injector

Volume: 50 µl Sample loop: Upper

Vial position: 1

OK Cancel

Figure 6 Delay volume calibration of fraction collector in Lab Advisor: Window of non-clustered fraction collector.

11 In the **Delay Volume Calibration** window set the following:

- **Required Modules:**
 - **Pump:** Preparative pump that corresponds to solvent A.
 - **Detector:** G1390B

Delay volume calibration

Select the modules that should be used for this calibration run:

Hint
Ensure that there's no remote start cable connected to the LC.

Required Modules

Pump: G1361A [S/N DEAAF00625]

Detector: G1390B [S/N DEABU00105]

Injector: G2258A [S/N DEAAP00116]

Clustering

Selection Valve: G1170A [S/N DEBAD00433]

Pump

Flow rate: 5 ml/min Stoptime: 0.5 min

Composition: ...

Injector

Volume: 5 µl Sample loop: Upper

Vial position: 1

OK Cancel

- **Injector:** Autosampler for calibration.
- **Clustering** (appears only for the first FC of the FC cluster):
 - **Selection Valve:** Select the valve that was clustered in the FC cluster.

Delay Time and Volume Calibration of Fraction Collector for UV (Lab Advisor) and MSD Signals
Performing a Delay Calibration with an Additional Detector

- **Pump:**
 - **Flow rate:** Set target flow of the main pump.
 - **Stoptime:** 4 min.
 - **Composition:** Click on “...” button and set composition to 70 % of solvent B.
- **Injector:**
 - **Volume:** 50 μ L
 - **Sample Loop:** Upper loop.
 - **Vial Position:** Enter position corresponding to the vial with the Prep LC Standards #2.
- If an *Agilent Active Splitter G1968D* is used:
 - If using Active Splitter Software (OpenLAB CDS Chemstation installation disk 6):
 - Set the Agilent Active Splitter to **Remote** (button on the front side of the splitter).
 - Start (and configure) Active Splitter Software.
 - In software enter the target main pump flow and set a split ratio (typically around 1:1000).
 - Start the splitter.

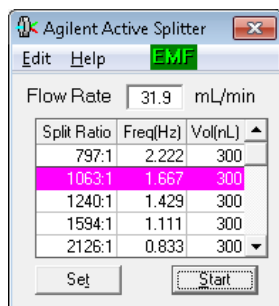

- Otherwise perform manual setup (see *MRA Operating Manual* which you can find e.g. on the *Agilent Purification & Preparative LC User Documentation DVD*):
 - Set Agilent Active Splitter to **Local**.
 - Use Split Factor table on page 5 and Calculating split ratio equation on page 6 of the *MRA Operating Manual* to set the target split ratio (typically 1:1000).
 - Start the splitter (to start or stop the splitter press simultaneously both **SET** and \uparrow buttons).
- Click **OK** button to start calibration.

Delay Time and Volume Calibration of Fraction Collector for UV (Lab Advisor) and MSD Signals

Performing a Delay Calibration with an Additional Detector

- 12 During initialization, which can take several minutes, the FC arm moves forward and the procedure asks to install the FDS adapter and close the FC door.

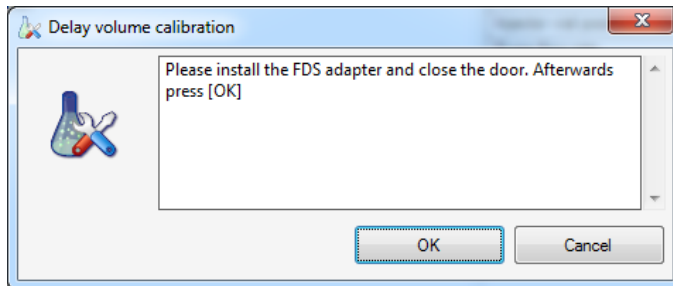

- 13 After the sample is injected it is possible to click on **Signals** tab to see UV detector and delay sensor signals.

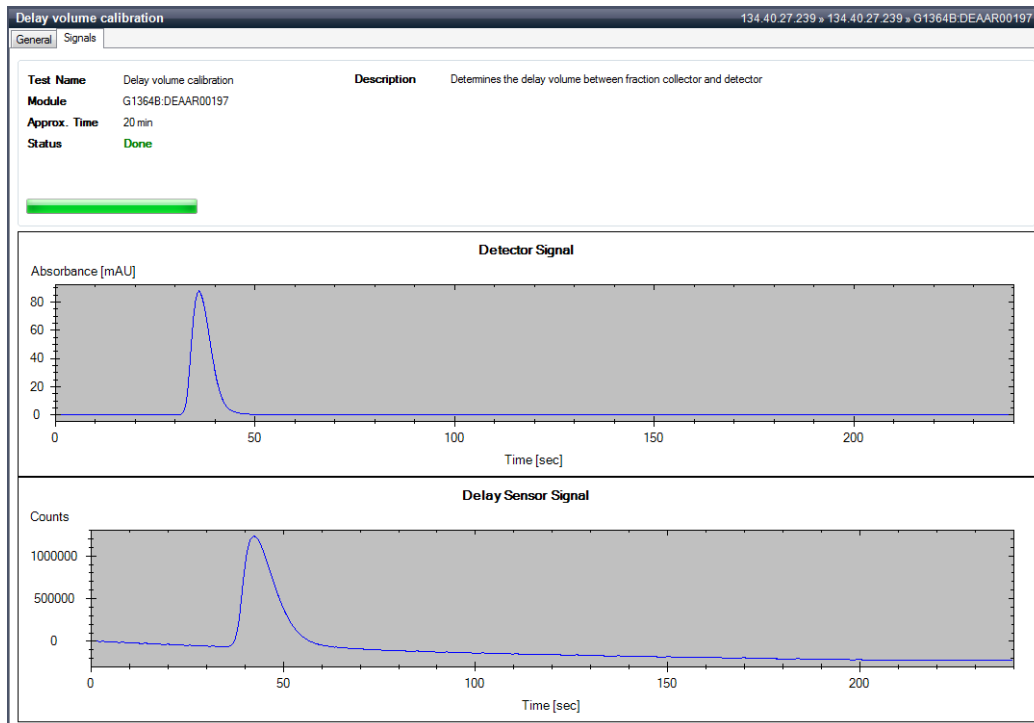

- 14 The results are displayed after completion.

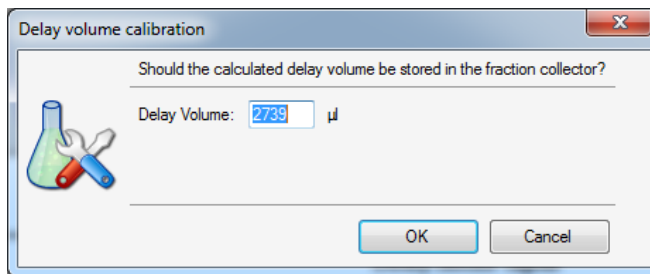

NOTE

Keep a record of this delay volume, for further use in Automated Purification Software for example.

- 15 After the end of calibration, the procedure offers to stop main flow (recommended), switch off UV lamp and remove the FDS adapter.

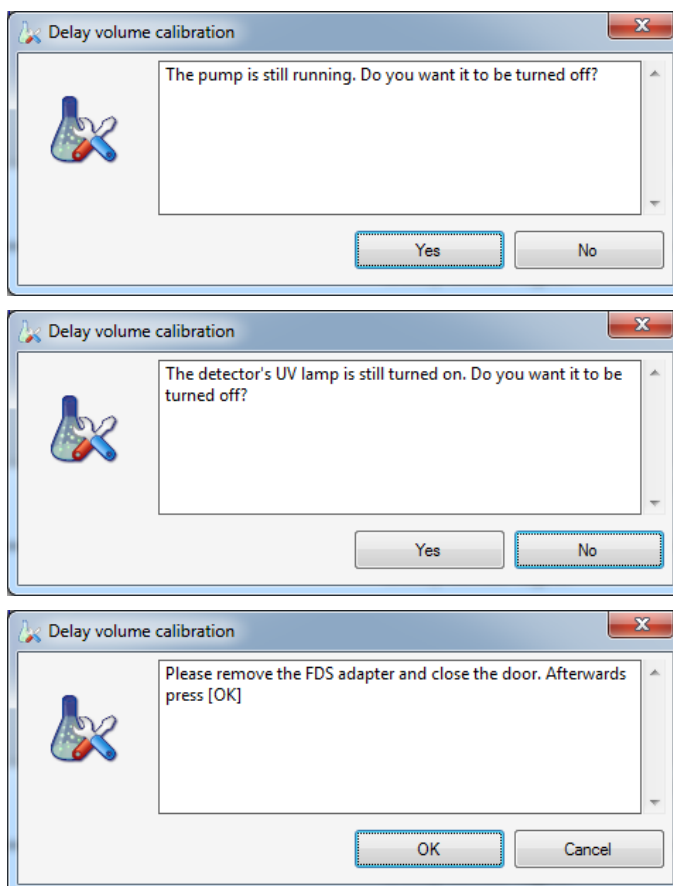

- 16 Connect back the remote start cable to LC stack (if used).
- 17 Stop the splitter, go to **Instrument Control**, and stop the make-up pump.
- 18 The delay volume must be positive otherwise the calibration is invalid. In such a case see “[Insufficient UV to FC delay volume](#)” on page 23 or “[Insufficient MSD to FC delay time](#)” on page 24.
- 19 The delay volume is written to the FC firmware and the value is coupled with the used UV detector and will be used for fraction collection. To check or change the value, go to **Service & Diagnostics > select FC > Delay Volume Tool**.
- 20 If applicable, set the same delay volumes for other fraction collectors by **Service & Diagnostics > select the other FCs > Delay Volume Tool**. In case of different lengths of capillaries between the FC and UV detector execute Delay Volume Calibration for each FC in order to calibrate them individually but if FC clustering is used, remove it first from the instrument configuration.

Performing a Delay Calibration with an MSD

The procedure calibrates the delay time between the UV detector and MSD using a standard run in Agilent OpenLab CDS ChemStation software. As explained above (see “Performing a Delay Calibration with an UV Detector” on page 8). When a flow splitter is used, the calibration can be used only for runs with identical tubing and settings of preparative and make-up pump flow.

Table 7 Recommendations for fraction collector delay calibration

Scale	Column	Flow rate	Injection volume
Analytical	Use the zero dead volume union instead of a column	1 – 5 mL/min	25 µL
Preparative	9.4 mm id	6 mL/min	25 µL
	21.2 mm id	25 mL/min	50 µL
	30 mm id	45 mL/min	75 µL

Parts required

p/n	Description
G1946-85020	Delay Sensor Calibrant Calibration time solution For delay calibration with analytical scale fraction collector
0100-0900	1/16 in union, zero dead volume, stainless steel For delay calibration with analytical scale fraction collector
5190-6887	Agilent Standard #2 (Delay time calibration solution for 1260 LC-MS) For delay calibration with preparative scale fraction collector
5190-5108	Regenerated cellulose filters, 15 mm diameter, 0.2 µm pore size For delay calibration with preparative scale fraction collector

Preparations

- Solvent A: water with 0.1 % formic acid.
- Solvent B: acetonitrile with 0.1 % formic acid.
- Make-up solvent: 80 % acetonitrile in water with 0.1 % formic acid.
- Needle purge and wash solution for the dual loop autosampler (degassed in ultrasonic bath): 80 % acetonitrile or another suitable solution (methanol should not be used with dual-loop autosampler due to peristaltic pump tubing – check the dual-loop autosampler manual)

Performing a Delay Calibration with an MSD

- 1 Switch off all pumps
- 2 Fill at least 700 µL of the sample to a vial and place it to the injector

NOTE

Filter Agilent Standard #2 (5190-6887) sample before use with PTFE syringe filter, 0.2 µm, 15 mm (5190-5084).

- 3 Place a tray into the fraction collector with a valid collection position (for example a tube tray or a plate tray with a plate and set the plate up in the fraction collector’s **Assign WellPlates...** window – accessible via right-click on the fraction collector instrument icon).

- 4 Set-up the method:
 - Use a Default Purification Method.
 - Save the Method as **UV_MSD_Calibration**.
 - Disable fraction collector triggering:
 - In the Method parameters of the fraction collector, select **Off** on the **Fraction Trigger Mode**.
 - Disable the Mass fraction collector triggering:
 - In the Fraction Collector settings of the MSD, select **None** on **FC Mode**.
 - Set **Stop Time** to **No Limit** in all modules (infinite run time).
 - For the analytical or preparative pumps:
 - **Set Solvents: 70 % B**.
 - Clear Time Table.
 - Injection volume, see [Table 7](#) on page 20.
 - If using dual loop autosampler:
 - Set **Injection Loop** to **Upper**.
 - Set **Partial loop filling**.
 - UV detector:
 - Set UV detector to 600 nm wavelength with 4 nm bandwidth and no reference.

NOTE

Alternative wavelength setting is 280 nm with 4 nm bandwidth and no reference

- Mark **Vis lamp** in Lamps on required for acquisition if available.
 - Set the active splitter to **Local** if available (in order to execute external contacts timetable in the UIB method).
 - Save the Method changes.
- 5 If using the dual loop autosampler:
 - Make sure that the Upper loop is in the main flow path (right-click on the autosampler diagram and check if a valve command refers to **Switch Valve to Lower Loop**. If not select **Switch Valve to Upper Loop** command).
 - Wash needle (right-click on **autosampler diagram** > **Wash Needle** > **Flush Port**, 15 s).
 - Purge needle (right-click on **autosampler diagram** > **Start Purging...** 3x).
 - 6 If using a column (for preparative fraction collector), purge the column with 70 % of solvent B using the recommended flow rate for 2 min.
 - 7 Adjust the preparative and make-up using the same combination of flow rates as during the delay calibration in Lab Advisor.
 - 8 Switch on all modules.
 - 9 Monitor 600 nm UV signal and positive scan MSD signal in **Online Plot**.
 - 10 Go to Sample Info window:

Delay Time and Volume Calibration of Fraction Collector for UV (Lab Advisor) and MSD Signals
Performing a Delay Calibration with an MSD

- Set **Vial/Location** of the sample vial.
 - Enter a run name.
 - **Run Method.**
- 11** Stop the run after the delay marker peak is eluted.
- 12** Clean the dual-loop autosampler if used:
- Purge needle (right-click on **autosampler diagram** > **Start purging...** 3x).
 - Wash needle (right-click on **autosampler diagram** > **Wash Needle** > **Flush Port**, 15 s).
- 13** Evaluate data (in mL and min units):
- Load MSD positive scan data and read time at the peak apex (signal maximum), t_{MSD} .
 - Load UV 600 nm data and read time at the apex of the peak, t_{UV} .
 - UV / MSD delay time: subtract MSD and UV time, $t_{UV/MSD} = t_{MSD} - t_{UV}$

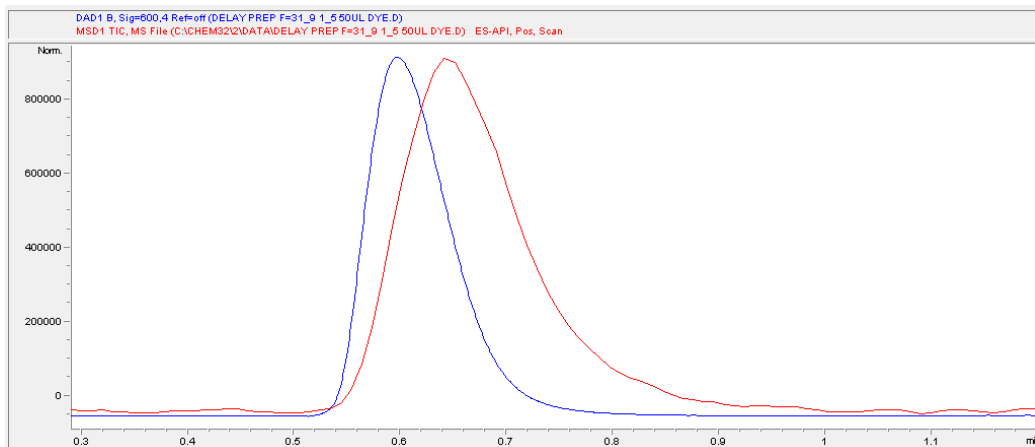

Figure 7 UV / MSD delay time calibration as a time offset between MSD (positive scan, red curve) and UV detector (600 nm, blue curve) at the apex of peaks.

- 14** Check value of MSD to FC delay time ($t_{MSD/FC}$):
- Recalculate UV to FC delay volume from the Lab Advisor calibration to the delay time using applied flow F: $t_{UV/FC} = V_{UV/FC}/F$
 - Calculate **MSD to FC delay time** as a difference between UV to FC and UV to MSD delays: $t_{MSD/FC} = t_{UV/FC} - t_{UV/MSD}$
 - Calculate **MSD cycle time** from measured UV/MSD data: Load MSD positive scan data again, select Integration mode (first icon below the list of files) and use Analysis Time and Datapoints in the File Information table below the graph to calculate the cycle time:

$$\text{Cycle Time (sec/cycle)} = (\text{Analysis Time in min}) * 60 / \text{Datapoints}$$
 - Calculate a ratio of the MSD/FC delay time and cycle time:

$$\text{Ratio} = t_{MSD/FC} * 60 / \text{cycle time.}$$
 - The ratio of MSD/FC delay time and the cycle time must be at least three but recommended is four ($t_{MSD/FC} > 3x$ or better $4x$ cycle time). If not, then

the MSD-based collection may not be performed correctly (insufficient MSD datapoints for a correct FC triggering decision) - see “Insufficient UV to FC delay volume” on page 23 or “Insufficient MSD to FC delay time” on page 24.

If the $t_{MSD/FC}$ is sufficient, the value need to be reported under the MS Fraction collection settings. Once in the MS **Fraction Collection**, click on **Parameters** and change if required the **Collector Delay (min)** to the value calculated during the delay time calibration.

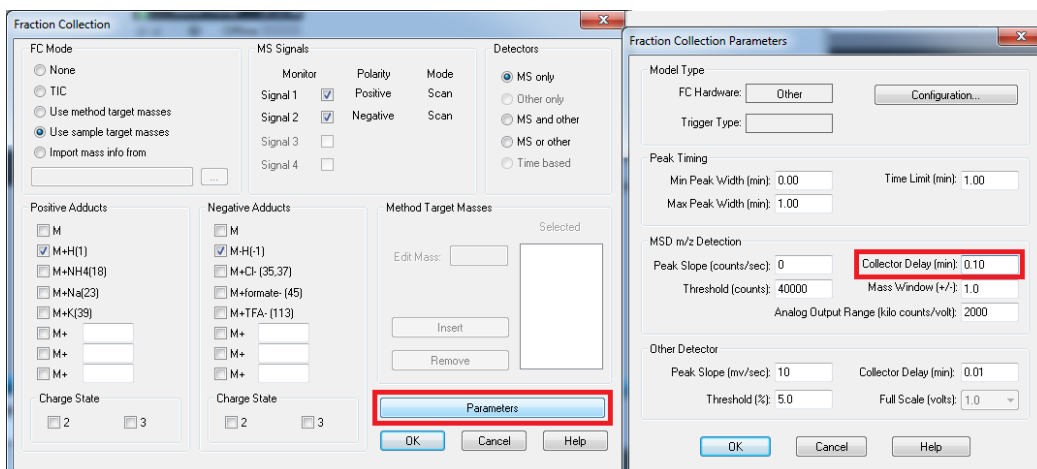

Tips and Tricks

Insufficient UV to FC delay volume

There are several reasons why the UV to FC delay volume may be too low:

- The volume of delay tubing in front of FC is too low.
- The make-up flow is too low for the applied preparative flow. There are limitations for combinations of preparative and make-up flows, see “Performing a Delay Calibration with an UV Detector” on page 8.
- The volume of tubing between the splitter and detector(s) is too high.

There are several ways how to increase the UV to FC delay volume but each of them has a certain disadvantage so consider the most suitable option for the given situation:

- Increase the volume of delay tubing in front of FC (increases peak volume in FC).
- Decrease the preparative flow (influences chromatography).
- Increase the make-up flow (increases speed of analytes when passing through detectors that results in narrower and smaller peaks so consider sufficiency of the signal response and the detector data rate).

- Decrease the volume of tubing between the splitter and detector(s).

After one or more solutions are applied, repeat the FC delay calibration from the beginning.

Insufficient MSD to FC delay time

Since the MSD / FC delay time is the difference: UV/ FC - UV / MSD (see step 13 on page 22), the both sources influence the MSD / FC value. Reasons for insufficient MSD / FC delay time may be following:

- The volume of delay tubing in front of FC is too low.
- MSD cycle time is too high.
- The make-up flow is too low for the applied preparative flow. There are limitations for combinations of preparative and make-up flows - see [“Performing a Delay Calibration with an UV Detector”](#) on page 8.
- The volume of tubing between the splitter and detector(s) is too high.

The following suggestions are options how to increase the MSD / FC delay time but each of them has a certain disadvantage so consider the most suitable way for the given situation:

- Optimize the MSD cycle time in the MSD method:
 - Use only one polarity if suitable (requires detailed knowledge of collected compounds).
 - Optimize peakwidth parameter – decrease it until MSD signal noise is still acceptable.
 - Decrease MW range or increase MW step size if suitable - it will not typically directly decrease the cycle time but it allows further decreasing of the peakwidth parameter (short MW range hides potential contaminants).
 - Performing MSD maintenance can also help in optimization of the noise level.
- Increase the volume of delay tubing in front of FC (increases peak volume in FC).
- Decrease the preparative flow (influences chromatography).
- Increase the make-up flow (increases speed of analytes when passing through detectors that results in narrower and smaller peaks so consider sufficiency of the signal response and the detector data rate – especially the MSD data rate is limiting).
- Decrease the volume of tubing between the splitter and detector(s).

NOTE

Repeat calibrations:

- If only the MSD cycle time was changed, repeat only the Delay time UV / MSD calibration.
- In other cases repeat both UV / FC and UV / MSD calibrations.



G1364-90104

Part Number: G1364-90104

Edition: 03/2014
Printed in Germany

© Agilent Technologies, Inc 2014

Agilent Technologies, Inc
Hewlett-Packard-Strasse 8
76337 Waldbronn
Germany