

Neurotransmitter Analysis in Microdialysates with ALEXYS®

Antec®
Proven Performance!

Lusi van Heerwaarden, Hendrik-Jan Brouwer, Martin Eysberg, Nico Reinhoud

Antec, Industrieweg 12, 2382 NV Zoeterwoude, The Netherlands



ALEXYS® Monoamines Analyzer

Introduction

Microdialysis is an established technique for studying physiological, pathological and pharmacological changes of a wide range of low molecular weight substances in the brain extracellular fluid. One of the main areas of application of microdialysis is the sampling of neurotransmitters in discrete brain regions. For many years, HPLC with electrochemical detection has been the method of choice for neurotransmitter analysis in microdialysates due to its high selectivity and sensitivity.

The neurotransmitter levels in microdialysate samples are often below the nanomolar and sometimes even below picomolar concentration range. Available sample volumes are usually small (1-15 µL) due to the low microdialysis flow rate (0.5 - 2 µL/min) and the high temporal resolution required. Therefore, the analysis of neurotransmitters in microdialysates puts demanding requirements on the analytical method and HPLC hardware used.

A number of dedicated solutions for the analysis of monoamine- and amino acid neurotransmitters, acetylcholine and their respective metabolites in microdialysates and tissue homogenates are presented. The ALEXYS® neurotransmitter analyzers are optimized for the analysis of small volume samples without making compromises on sensitivity.

ALEXYS® Monoamines Analyzer

For Biogenic Amines and Acidic Metabolites

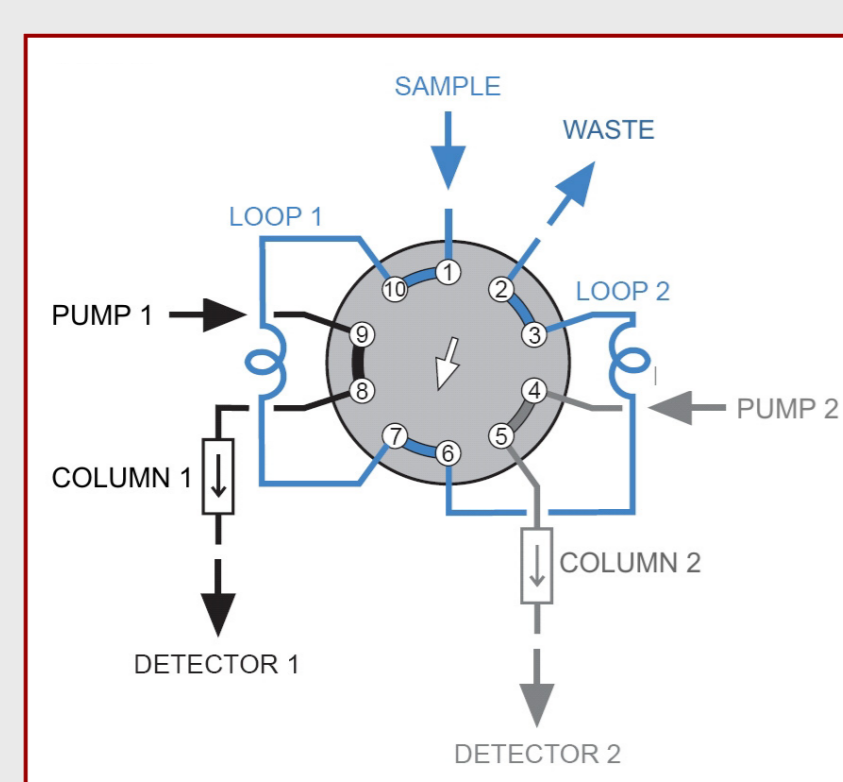

- Dual channel HPLC system equipped with 10-port valve and two loops in series for parallel injection.
- Simultaneous analysis of all catecholamines and acidic metabolites with optimal sensitivity:
Channel 1 - NA and/or Metabolites
Channel 2 - DA and 5-HT
- Analysis time < 20 minutes
- Detection limit 0.3 fmol on column (100 pM/3 µL)
- Required sample volume 10 µL

Chromatograms of Mouse Prefrontal Cortex

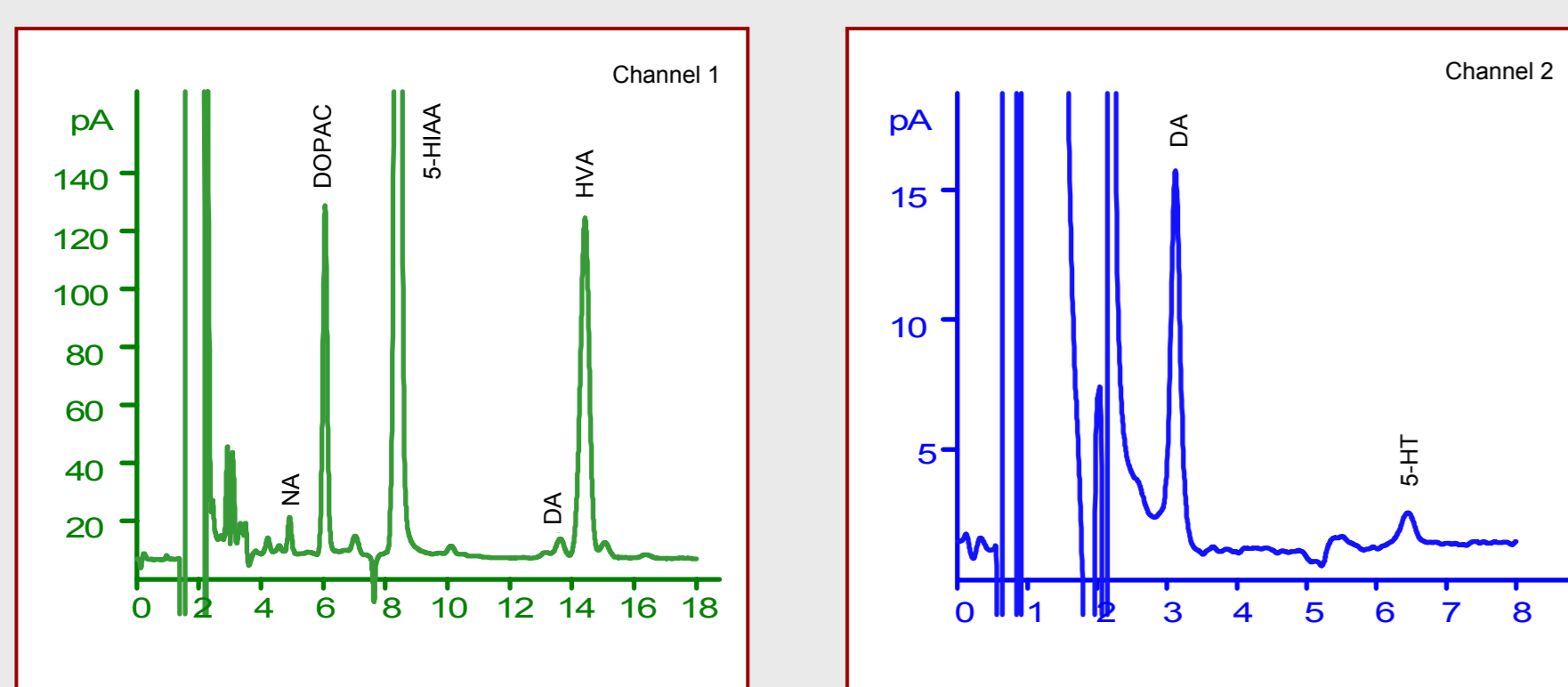

Figure 1. Channel 1 was optimised for analysis of NA and metabolites (acidic mobile phase). Courtesy of Mrs. Gerdien Korte-Bouws, Psychopharmacology, University of Utrecht, The Netherlands.

Chromatograms of Rat Prefrontal Cortex

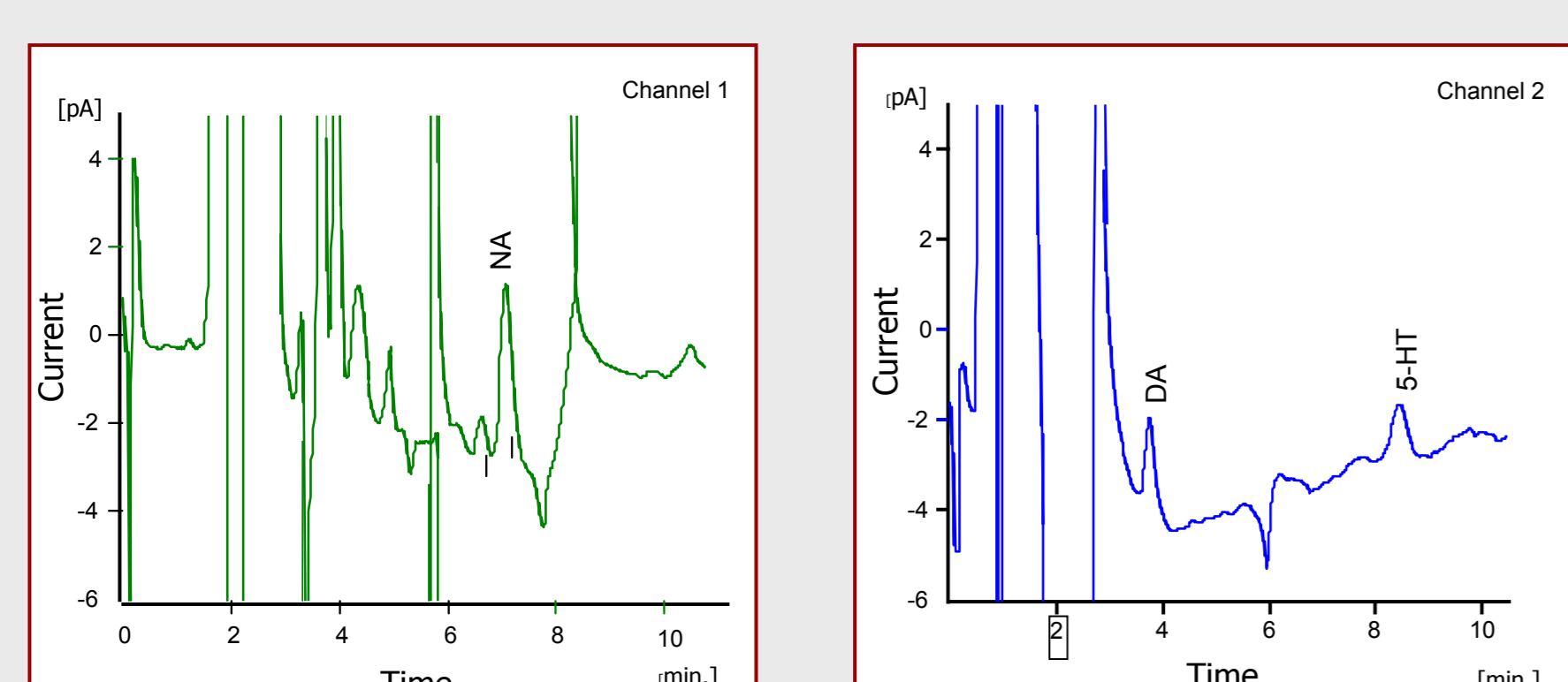
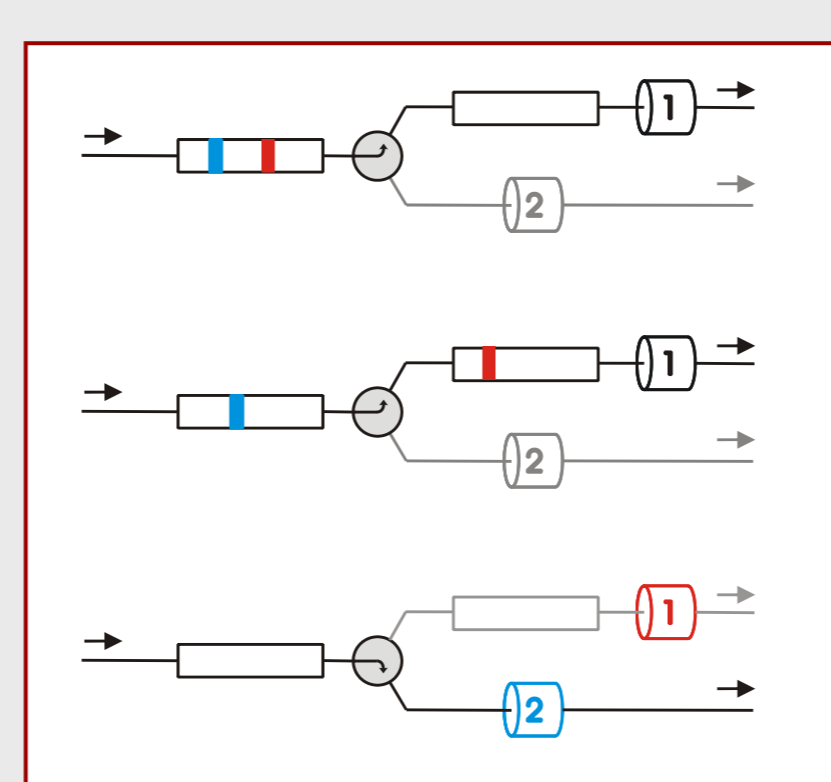

Figure 2. Channel 1 was optimised for analysis of NA only (detector settings selective for NA, and mobile phase with pH 6.0).

ALEXYS® GABA and Glu Analyzer

For GABA and Glutamate



- Automated pre-column derivatization of aminoacids with OPA/sulphite reagent (odourless) into stable and electrochemically-active isoindol sulfonates.
- Column switching concept to resolve Glutamate from interferences in the chromatographic front and to reduce the total analysis time (fast elution of GABA).
- Analysis time < 25 minutes (including derivatization)
- Detection limit GABA 50 fmol on column (10 nM/5 µL)
- Required sample volume 13 µL

Reproducibility

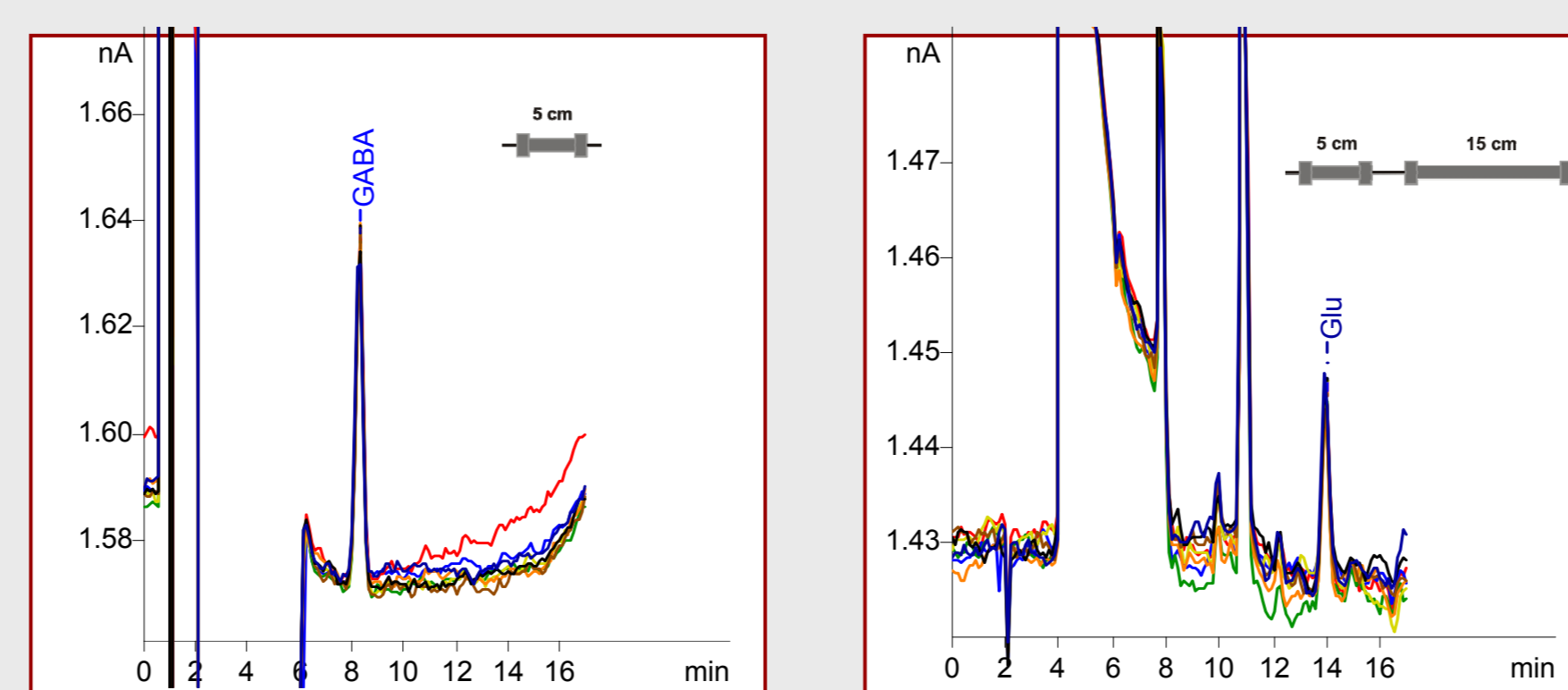

Figure 3. Overlay of 8 chromatograms of a 50 nM GABA and Glu standard.

Chromatograms of Basal Lateral Amygdala

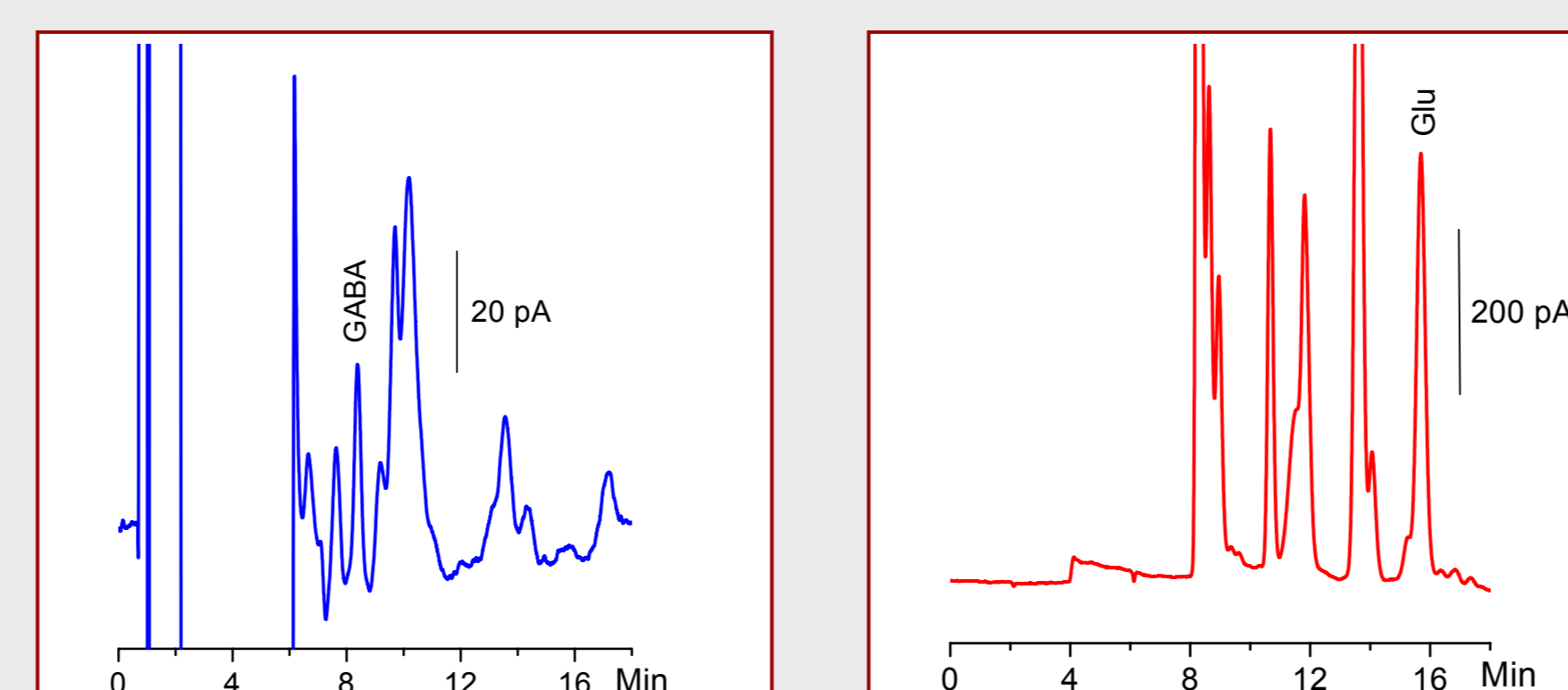
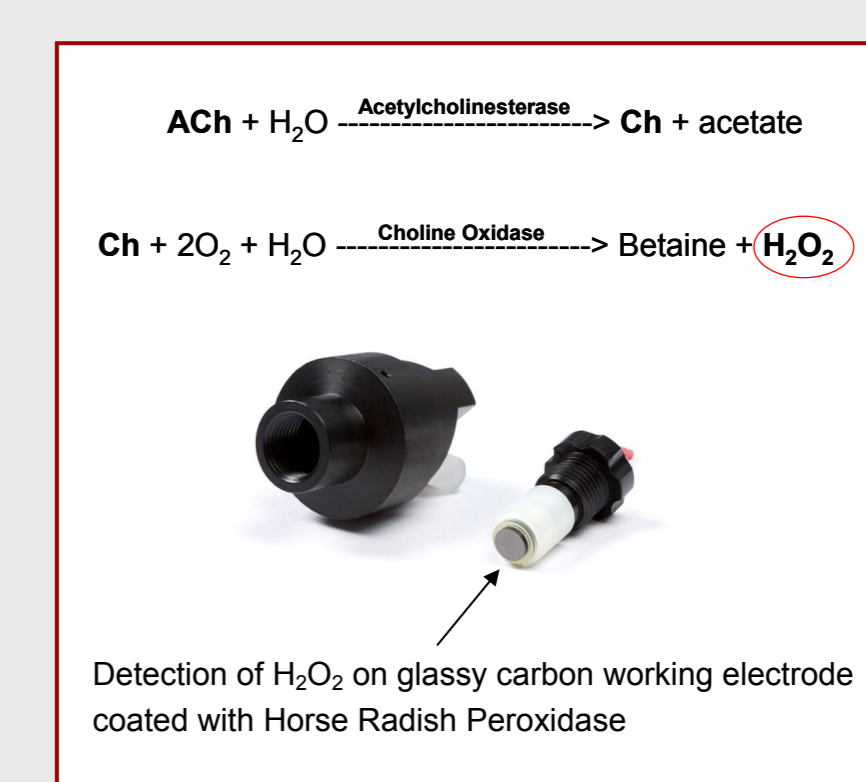

Figure 4. Analysis of GABA and Glutamate in pooled dialysate from Basal Lateral Amygdala.

ALEXYS® Acetylcholine Analyzer

For Acetylcholine and Choline



- Selective Post-column Immobilized Enzyme Reactor (IMER) for the conversion of ACh and Ch into electrochemically detectable H₂O₂.
- FLEXCELL™ in combination with Glassy carbon electrode with Horseradish Peroxidase (HRP) coating for better sensitivity, detection limits and baseline stability.
- Analysis time < 15 minutes
- Detection limit 10 fmol on column (2 nM/5 µL)
- Required sample volume 7 µL

Detection Limit and Reproducibility

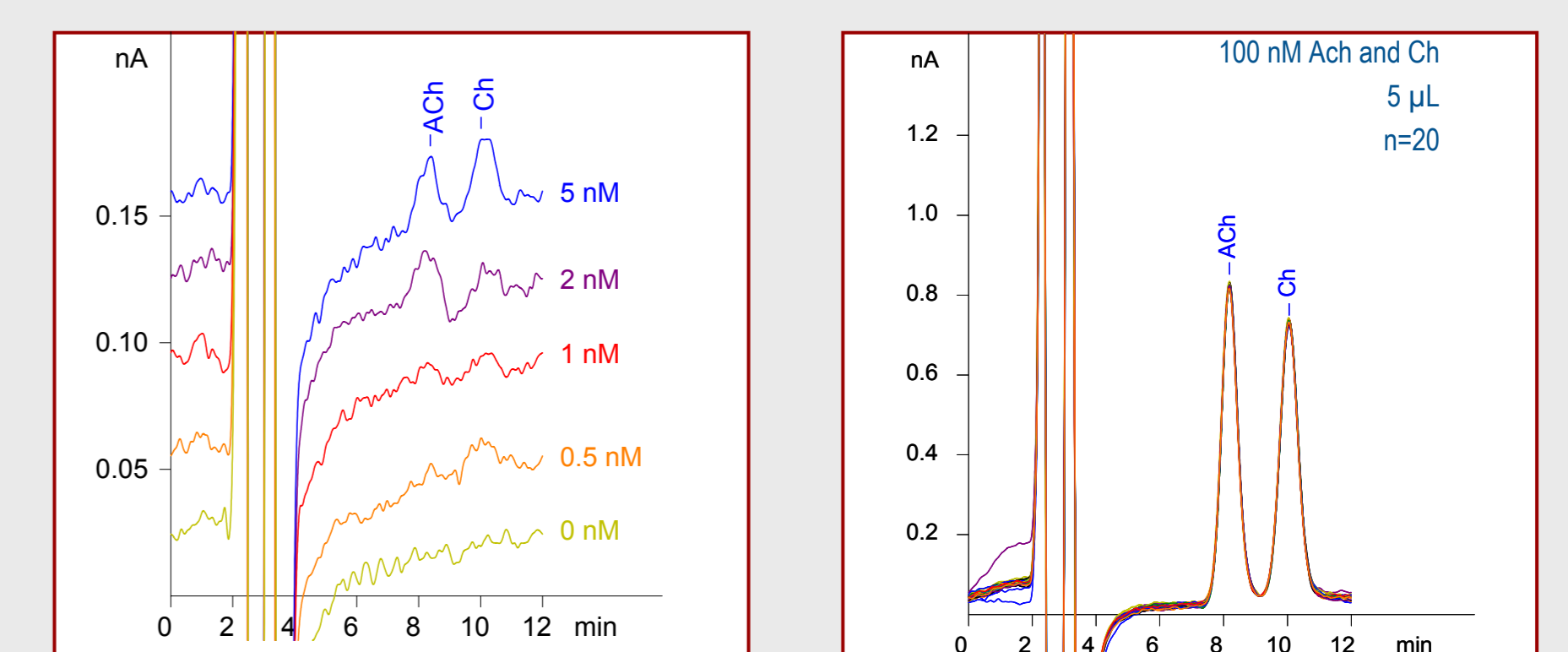

Fig. 5. Chromatogram overlay of different concentrations near LOD, and overlay of 20 chromatograms of 100 nM ACh and Ch (5 µL).

Conclusions

ALEXYS® Analyzer are a proven concept for neurotransmitter analysis.

- Superior detection sensitivity
(optimized conditions for each LC channel/application)
- Optimized for small sample volumes
(efficient sample use by customized injection programming)
- Efficient system solution
(Simultaneous analysis of different types of neurotransmitters in one sample with one injection using dual-channel approach)