



P0 BOX 277 465 Limestone Road, Oxford, PA 19363

Phone 610-932-3636 Fax 610-932-4158

## TABLE OF CONTENTS

### SECTION 1. Contents

Informational symbols 1.3

### SECTION 2. Specifications and warranty

Pyroprobe 5000 specifications 2.1

Pyroprobe 5150 specifications 2.2

Pyroprobe 5200 specifications 2.3

Warranty 2.4

Consumables and part numbers 2.6

### SECTION 3. Product description and probe calibration

Pyroprobe 5000 description 3.1

Front panel 3.2

Pyroprobe 5150 description 3.3

Start-up and calibration 3.4

Sample capacities 3.5

Care of filaments 3.6

### SECTION 4. Pyroprobe 1000 programming

Base screen 4.1

File menu 4.2

Edit menu 4.3

Tools Menu 4.4

Configuration menu 4.5

Communications menu 4.6

Filament programming 4.7

Accessory (interface) programming 4.8

Sequence	4.10
Isothermal zones	4.11
Method editor	4.12

## **SECTION 5. Pyroprobe GC Interfacing**

Model 1500 (isothermal)	5.1
Installation of 1500	5.3
Adapting the septum retainer	5.8
Operation of the 1500	5.9
Diverter valve installation	5.10
Inserts	5.11
Model 5150 installation (transfer line)	5.12
Electrical connections	5.14
Main fuse	5.15

## **SECTION 6. Alternative Probes**

Direct Insertion Probes for Mass Spectrometers	6.1
Probe connections for DIP	6.2
Connections for FT-IR probes	6.3
Thermocouple probes	6.4
Changing the ballast resistor	6.5
Quartz lined (protected coil) probe	6.7

## **SECTION 7. Pyroprobe FT-IR Interfacing**

Brill Cell Description	7.1
Installation, general	7.2
FT-IR cover	7.3
Pneumatics module	7.3
Pyrolysis using the Brill Cell	7.3
Brill Cell diagram	7.5
Universal mounting	7.8
Elevated pressure option	7.9

**SECTION 8. Sample Handling Kit**

Contents of kit

8.1

**SECTION 9. INDEX**

9.1

## INFORMATIONAL SYMBOLS



The WARNING symbol indicates that failure to observe the proper procedures described in this manual could result in injury to the operator.



CAUTION is used to indicate that failure to observe the proper procedures in this manual could result in damage to the Pyroprobe instrument.

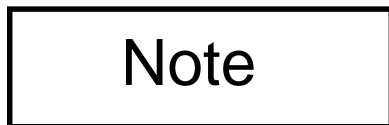

The NOTE symbol is used to call attention to particularly important sections of information within the text of this manual.



The Exclamation Point symbol is used on the Pyroprobe instrument to indicate that the adjacent parts should not be touched before becoming completely familiar with the information about those parts in this manual.



The Shock symbol is used on the Pyroprobe to indicate the potential for an electrical shock to the user, and that the Pyroprobe must be turned off and unplugged before accessing these parts.



The Hot Surface Warning symbol is used to indicate the potential that the indicated surface may be hot and should not be handled until the unit has been turned off and the part has cooled.

**SECTION 2. SPECIFICATIONS AND WARRANTY****SPECIFICATIONS****PYROPROBE 5000**

FILAMENT TEMPERATURE	Settable in 1°C increments to 1400°C
TIMES	Settable in units of 0.01 second to 999.99 sec. or in units of 0.01 minute to 999.99 min.
HEATING RATES	Settable in units of 0.01°C/millisecond from 0.01 to 20.00°C/mS, or 0.01 to 999.99°C/Second, or 0.01 to 999.99°C/Minute
INTERFACE TEMPERATURE	Settable in 1°C increments to 350°C
TIMES	Settable in units of 0.01 minute to 999.99 minutes
HEATING RATES	Isothermal Model 1500
DRY MODE	User selectable
CLEAN MODE	User selectable
SEQUENCE	Up to 8 methods, each with GC start
POWER REQUIREMENTS	115V, 50/60Hz; 220/240V, 50/60Hz

**SPECIFICATIONS**

## PYROPROBE 5150

FILAMENT TEMPERATURE	Settable in 1°C increments to 1400°C
TIMES	Settable in units of 0.01 second to 999.99 sec. or in units of 0.01 minute to 999.99 min.
HEATING RATES	Settable in units of 0.01°C/millisecond from 0.01 to 20.00°C/mS, or 0.01 to 999.99°C/Second, or 0.01 to 999.99°C/Minute
INTERFACE TEMPERATURE	Settable in 1°C increments to 350°C
TIMES	Settable in units of 0.01 minute to 999.99 minutes
HEATING RATES	Settable in units of 0.01°C/minute to 60.00 °C/minute.
DRY MODE	User selectable
CLEAN MODE	User selectable
SEQUENCE	Up to 8 methods, each with GC start
POWER REQUIREMENTS	115V, 50/60Hz; 220/240V, 50/60Hz

**SPECIFICATIONS**

## PYROPROBE 5200

FILAMENT TEMPERATURE	Settable in 1°C increments to 1400°C
TIMES	Settable in units of 0.01 second to 999.99 sec. or in units of 0.01 minute to 999.99 min.
HEATING RATES	Settable in units of 0.01°C/millisecond from 0.01 to 20.00°C/mS, or 0.01 to 999.99°C/Second, or 0.01 to 999.99°C/Minute
INTERFACE TEMPERATURE	Settable in 1°C increments to 350°C
TIMES	Settable in units of 0.01 minute to 999.99 minutes
HEATING RATES	Settable in units of 0.01°C/minute to 60.00 °C/minute.
DRY MODE	User selectable
CLEAN MODE	User selectable
SEQUENCE	Up to 8 methods, each with GC start
POWER REQUIREMENTS	115V, 50/60Hz; 220/240V, 50/60Hz

## WARRANTY

1. *Term of Warranty: Covered Events.* Products manufactured by CDS are warranted for one (1) year parts and labor from the date of shipment against defects in materials or workmanship.
2. *Handling of Warranty Claims:* CDS will repair or replace the defective product with out charge within the warranty period, provided the defective item is shipped to CDS Analytical, Inc., 465 Limestone Road, Oxford, Pennsylvania 19363. All items returned for warranty work must be assigned a Service Return Number (SR #) by the CDS Service Department before the equipment is returned to the factory. Equipment returned to the factory without this number will not be received. Cost of shipment to the factory must be paid by the Buyer; cost of return shipment to the Buyer will be prepaid by CDS. Repair or replacement of a defective item shall not extend the initial warranty term.
3. *Exclusions:* This warranty does not cover the following items and events.
  - a. Failure of mechanical parts due to normal wear and tear.
  - b. Electrical components that deteriorate due to age, such as tubes, lamps and the like.
  - c. Any defect caused by misuse, negligence, accident, or improper installation, except the installation in accordance with written directions supplied by CDS shall not be considered improper.
  - d. Certain parts such as septa, quartz tubes, platinum filaments, etc., are expendable in normal use and their service life is unpredictable. These items are not covered by this warranty.
  - e. Buyer-induced contamination or leaks.
4. *Limitation of Damages:* CDS SHALL NOT BE LIABLE FOR CONSEQUENTIAL DAMAGES OF ANY KIND ARISING OUT OF THE PURCHASE, INSTALLATION, USE OR MISUSE OF THE PRODUCTS. CDS'S LIABILITY FOR INCIDENTAL DAMAGES SHALL BE LIMITED TO THE PAYMENT FOR THE RETURN FREIGHT (AS SPECIFIED ABOVE) ON DEFECTIVE PRODUCTS SHIPPED TO CDS FOR REPAIR OR REPLACEMENT.
5. *Sole Warranty:* This warranty is given in lieu of all other warranties, express or implied. THERE ARE NO WARRANTIES WHICH EXTEND BEYOND THE DESCRIPTION ON THE FACE HEREOF. The Buyer having furnished or agreed to the specifications of the products sold, NO WARRANTY IS MADE AS TO THE FITNESS OF THE PRODUCT FOR ITS INTENDED PURPOSE. Except as specifically set forth herein, NO WARRANTY IS MADE AS TO THE MERCHANTABILITY OF THE PRODUCT.

6. *“Warranty Registration Card”*: The Warranty Registration Card included with this package must be returned to register the product.
7. *Modification in Design or Discontinuance of Products*: CDS reserves the right to discontinue manufacture of products without notice, and to make modifications in design at anytime without incurring obligation to make such modifications to products previously sold.

**ORDER NUMBERS FOR CONSUMABLES**

The following is a list of parts and accessories which are the most likely to be reordered and replaced, along with the corresponding part numbers. These items may be obtained directly from CDS Analytical, Inc. by calling 610-932-3636 and requesting the sales department.

<b><u>Item</u></b>	<b><u>Part Number</u></b>
1/4" Coil filament rod	10P25003
1/4" Ribbon filament rod	10P25002
Probe seals (25)	1002-0333
Graphite ferrules (10)	1006-0345
Economy quartz tubes (100)	10A1 3008
Fire-Polished quartz tubes (20)	10A1 3007
Quartz wool	1001-0345
Septum retainer for interface	1001-0162
Sample handling kit	0100-9014
Collar for 1/4" probe	2002-0642

Probe Rod Repairs - Each size and style of probe has a different part number. These numbers can be obtained by calling CDS Analytical.

## **SECTION 3. PRODUCT DESCRIPTION, PROBE CALIBRATION**

### **CDS ANALYTICAL, INC. PYROPROBE 5000**



#### **DESCRIPTION**

The CDS Analytical Pyroprobe 5000 is a multiple step, platinum filament pyrolysis instrument which prepares samples for analysis by gas chromatography, mass spectrometry or FTIR. The microprocessor of the Pyroprobe 5000 controls the temperature of the filament by calculating the resistance of the filament at setpoint temperature and supplying the correct voltage to achieve that temperature. Filaments are available in a variety of designs and sizes, and the Pyroprobe 5000 comes supplied with one ribbon probe, for placing samples directly onto the surface of the filament, and one coil probe, for pyrolysis of samples in a quartz tube. There are three basic modes of operation: Run, for pyrolysis of the sample in either a single step (like the Pyroprobe 1000) or in a sequence made of several methods; Dry, for removing solvent from a sample deposited as a solution onto the ribbon filament; and Clean, for removing residual material from the filament between runs. In the Pyroprobe 5000, the times and temperatures for the Dry and Clean features are user selectable.

The Pyroprobe 5000 is interfaced to a gas chromatograph by means of a heated chamber which houses the filament rod during pyrolysis. The temperature of this interface and the temperature of the pyrolysis filament constitute one method. A sequence of methods may contain up to eight steps, and each step includes an initial temperature, a heating ramp and a final temperature for the Pyroprobe filament, plus GC start. For the pyrolysis filament, the temperatures may go to 1400°C and the rates may range from 0.01°C/minute to 20,000°C/second, settable in degrees per minute, second or millisecond. For the interface, temperatures may be set to 350°C.

All programming, temperature selection, calibration and run initiation are performed through the PC interface of the Pyroprobe 5000. Selecting the Pyroprobe, Accessory or Sequence icon displays the required fields for those functions. One method includes the Pyroprobe initial, ramp and final setpoints, and Interface setpoints. Methods are saved, edited and recalled as with any other Windows based program. During a run, the actual temperatures for both the probe and interface are displayed on the screen, and setpoints may be examined in other program methods.

## FRONT PANEL



The front panel of the Model 5000 includes several LEDs for indicating the running status of the instrument plus keys which may be used to start and stop a method, run the dry function and run the clean function.

At the top of the panel are four status indicators which light Green when the zone is Ready and Red when it is not. These indicate the ready status of the Probe itself, the GC, the Reactant Gas option and an external input.

Below the ready status LEDs are running status LEDs which show the state of the 5000 when it is executing a method. One set of LEDs lights sequentially for the Initial, Ramp and Final steps of the probe filament, and a second set shows the same for the programmable interface zone.

Below these are four keys which permit starting the 5000 from the front panel instead of from the PC. To run, a method must be programmed and downloaded from the PC to the 5000, but then these keys may be used to execute the Dry and Clean functions, to Start the method and to stop (Reset) the method.

At the bottom of the front panel are two more LEDs which light to show that the Dry and Clean functions are in progress.

## PYROPROBE 5150



The Model 5150 adds to the Model 5000 the ability to program a low-mass interface zone. Instead of using the standard Model 1500 GC interface on the injection port of the GC, the Model 5150 incorporates the interface zone into the body of the Pyroprobe, and connects to the GC using a heated transfer line. In addition, the on-line/off-line valve is placed into a separate valve oven. This greatly reduces the mass of the interface and permits heating and cooling the interface zone of the Pyroprobe quickly. All of the setpoints and features of the Pyroprobe filaments themselves are the same for the 5000 and 5150, and both instruments may run a sequence of up to eight methods.

In the Pyroprobe control software, under Configuration, then Accessory type, the 1550 must be selected when using the 5150. In addition to providing rapid heating and cooling of the interface zone, the 5150 automatically places the Pyroprobe on-line and off-line for multiple runs in a sequence.

## PYROPROBE 5200

The Model 5200 adds to the 5150 a second heated zone connected to the valve oven. This second zone may be used with a sorbent as a trapping zone, permitting the use of a reactant gas for pyrolysis. In this mode, air sweeps the Pyroprobe filament during pyrolysis, but the flow goes to the trap, not to the GC. After collection, the trap zone is placed on-line with the GC and desorbed to make the injection.

## START-UP AND CALIBRATION

To insure probe-to-probe reproducibility of pyrolysis temperature, each probe rod is tested and calibrated at the factory by CDS Analytical. A calibration number is determined for each rod, and this number is printed on the shaft of the rod (see diagram below). This number is entered into the computer under the Configuration menu as shown below. By clicking on Configuration, then Probe Cal #, a small window is brought up that asks for the numerical value of the figure on the probe rod band. Simply enter this number and click on OK.

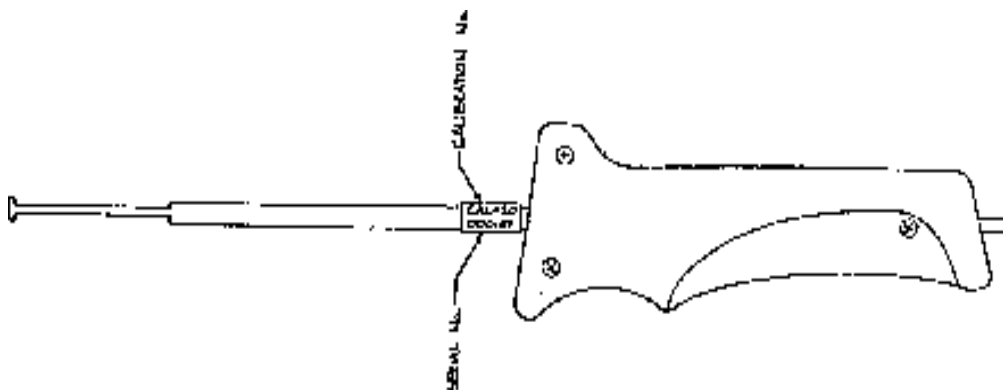
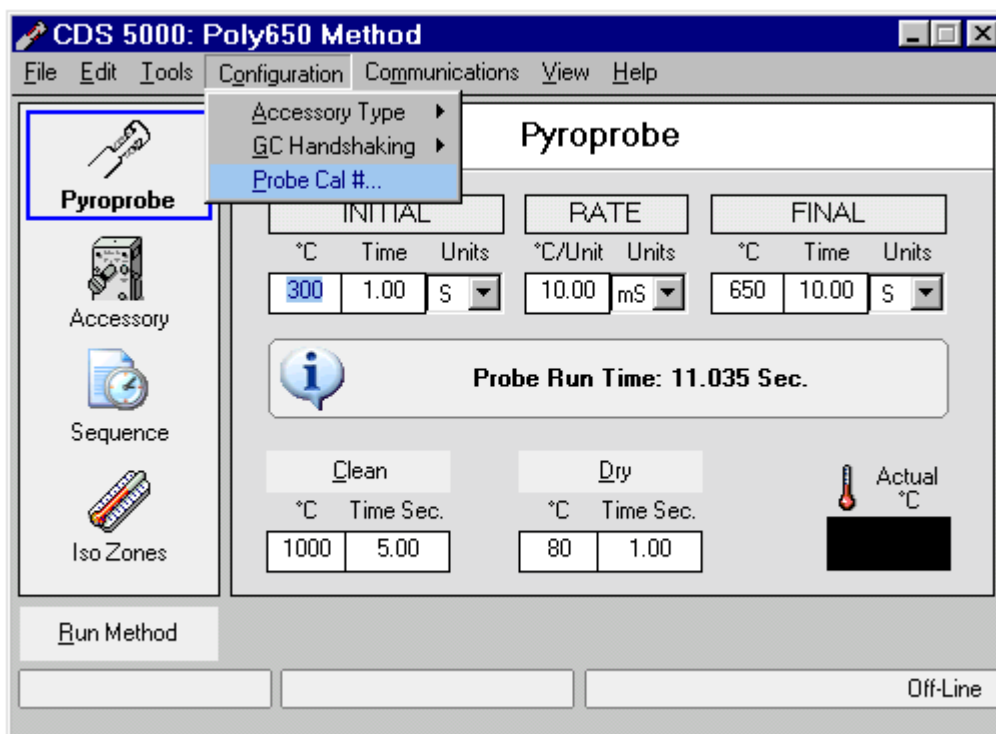

## PYROPROBE SAMPLE CAPACITIES

When introducing a sample to a gas chromatograph by pyrolysis, it is important to consider the GC capacity in deciding sample size. Most gas chromatographic analyses use approximately 1  $\mu$ L sample injections, which translates to about 1 mg of total sample. If a pure organic material, such as a synthetic polymer, is being pyrolyzed, it will be completely vaporized in pyrolysis, and transferred to the GC. It is important that the sample is small enough to ensure complete pyrolysis at the final temperature, and not overload the analytical system. In general, sample sizes of 10 to 100  $\mu$ g will pyrolyze readily and not exceed the capacity of the GC column.

Some analysts pyrolyze samples which are not all organic, or are not completely vaporized, such as soils, fuel source minerals and composites. Consequently, they must use larger samples to increase the amount of organic material actually delivered to the GC.

Listed below are the standard quartz tubes and boats available for the coil Pyroprobes, with approximate maximum sample capacities for each. These assume that the quartz tube is no more than 1/2 full, and are based on a sample density of 1.0. Dimensions are in overall Length, Inside Diameter for the tubes, and Depth for the boats.

Probe Size	Quartz Tube Dimensions	Capacity	Boat Dimensions	Capacity
1/4"	25 mm L, 1.9 mm I.D. PN 10A1-3007	40 mg	25 mm L, 1.5 mm D PN 1001-0346	50 mg
1/2"	25 mm L, 5 mm I.D. PN 1005-0348	250 mg	20 mm L, 6 mm D PN 10A1-3001	300 mg

## CARE OF PYROPROBE FILAMENTS

The filament of the Pyroprobe is made of platinum and may be distorted through improper handling. The temperature of the filament is dependent on the resistance of the platinum, and will be adversely affected if the filament is bent or damaged. In addition, bending the coil so that the loops touch each other, or the side of the probe body, will cause the probe to short circuit, overheating and damaging the filament.

Ribbon filaments expand when heated and may touch the inside of the interface when fired, causing the filament to short and burn out. To prevent this, observe the flex of the ribbon while firing it in air, and be sure that it deflects toward the center of the probe rod, instead of away from the rod.

Always be sure to insert the quartz sample tubes straight into the coil to minimize the chance of coil damage. Never operate the Pyroprobe if the coil is touching the side of the probe body or if the coil has been compressed so that the loops are touching.

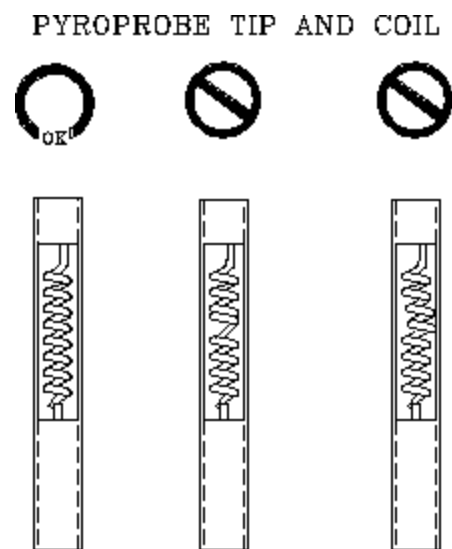

If the coil has become bent or distorted, it may be straightened using fine point tweezers. First, insert a quartz tube into the coil to stabilize it. Then using gentle pressure with the tweezers, adjust the loops of the coil so that they are not touching each other or the side of the probe.

If a coil cannot be straightened satisfactorily, it should be replaced with a new probe rod. The damaged rod may be sent back to CDS Analytical for repair, which includes replacement of the coil element with a new coil and recalibration of the probe rod.

## PYROPROBE RIBBON FILAMENTS

When using a ribbon filament probe rod with a standard Pyroprobe interface, be sure that the filament flexes away from the interface so that platinum ribbon does not touch the inside the interface. If the filament contacts the interface during firing, it could become damaged. Test fire the Pyroprobe in the air to see the direction of flexing as the filament heats. If the ribbon flexes outward, press it gently (when cold) toward the center of the probe rod, and fire again to insure that it now flexes inward, away from the interface wall.

When applying a sample to the ribbon, be careful not to puncture or tear the platinum. This will cause overheating at the damaged spot, and will destroy the filament.

**The Pyroprobe ribbon filament is attached at the center post of the probe rod and at the edge of the rod itself at the tip. When heated, the filament expands and flexes. Be sure that the flex is toward the center of the rod and not outward. If the filament flexes outward, it may touch the inside of the interface and break.**

**Ribbon Filament Cold**



**Correct flexing of the ribbon when heated.**



**Outward flexing of the ribbon when heated. This may cause a short and destroy the filament.**

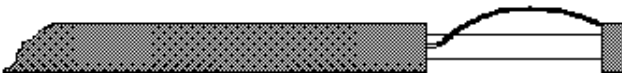

## SECTION 4. PROGRAMMING

All control setpoints for the Pyroprobe 5000 are entered through the Windows based control software installed on a PC. Installation provides an icon on the desktop, which is double-clicked to produce the base screen for the Pyroprobe.

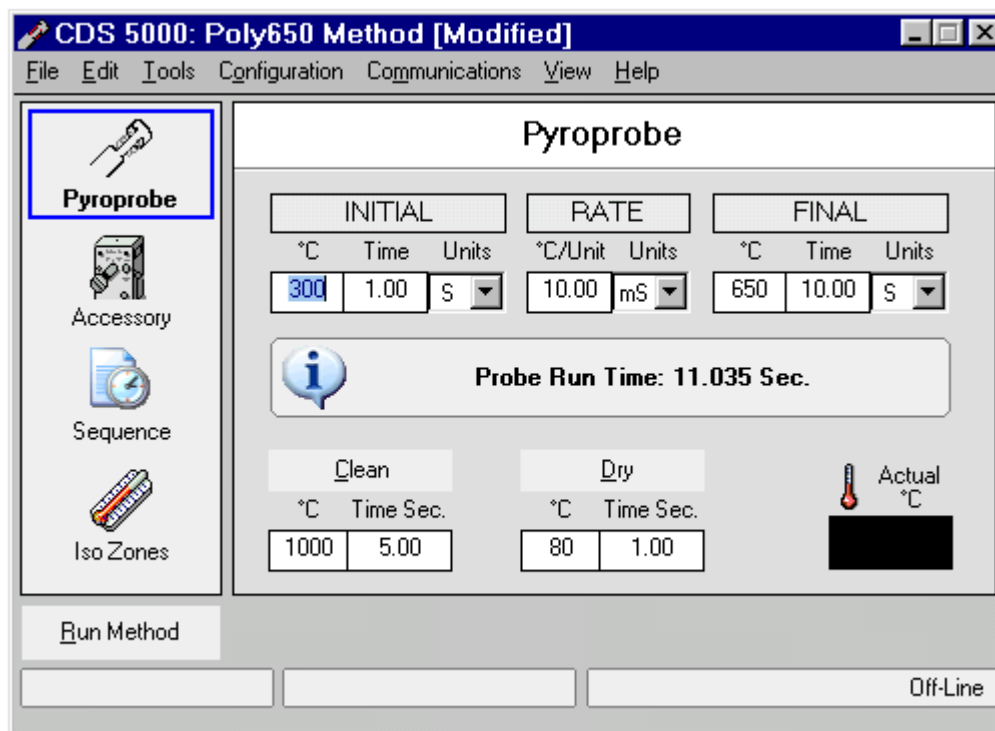

This base screen has icons on the left side for the Pyroprobe, the Accessory (interface) establishing a Sequence of methods and for displaying Isothermal Zones. Across the top of the screen is a menu bar with selections for:

File  
 Edit  
 Tools  
 Configuration  
 Communication  
 View and  
 Help.

The functions of these menu items, as well as basic setpoint entry, are described on the following pages.

## FILE MENU

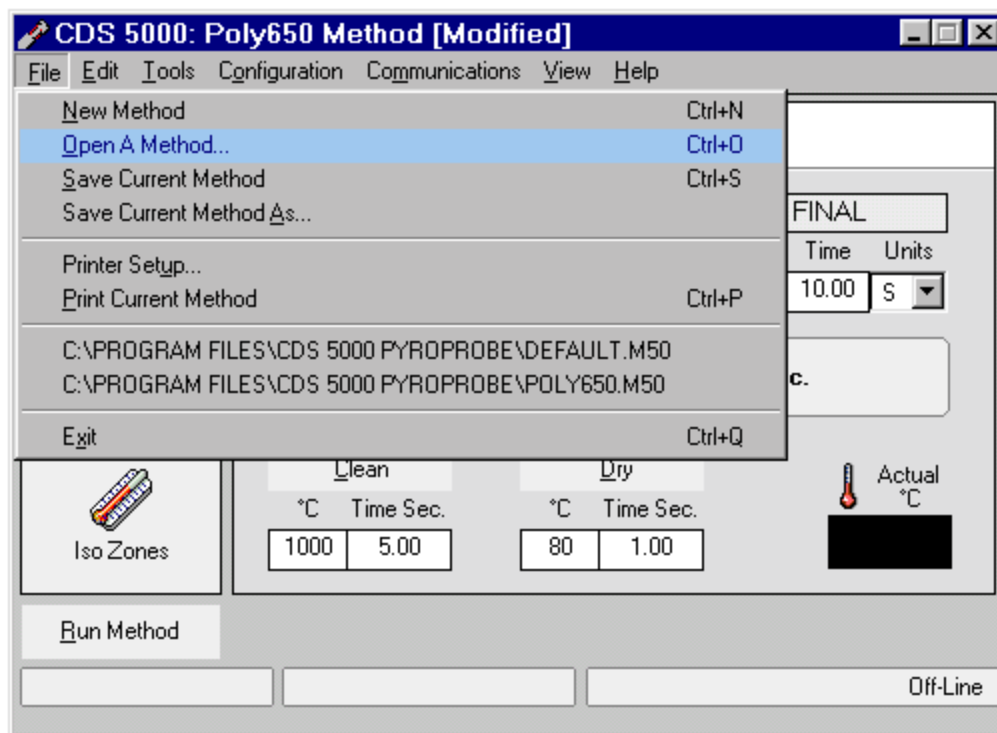

Selecting *FILE* from the menu bar produces choices for starting a new method, saving the method, opening a previously saved method, etc., as well as setting up printer parameters. Selecting *New Method* will enter zeroes into all fields of the display so that a completely new method may be created. Methods include all setpoints (both probe and accessory or interface) and are saved with the extension .m50. Selecting *Save Current Method* saves any changes using the existing method name. Selecting *Save Current Method AS* will save the current setpoints but allow the use of a new method name.

## EDIT MENU

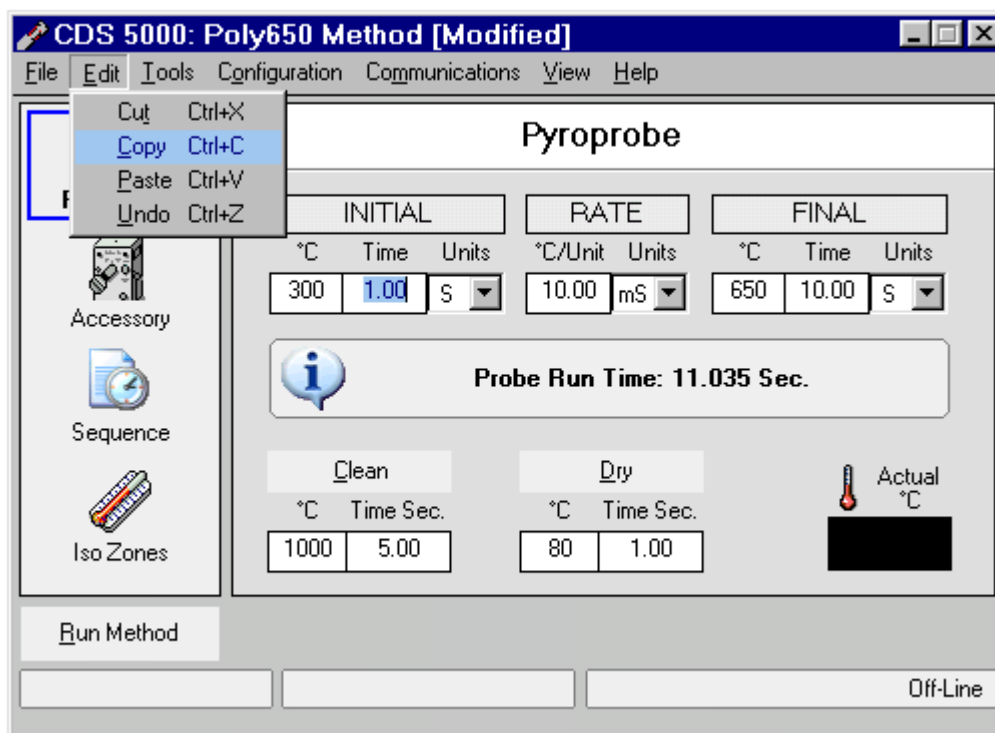

Selecting *EDIT* from the menu bar permits the use of typical edit functions such as cut, copy and paste. As with other Windows type programs, the entry to be cut or copied must be hi-lighted before the function is selected.

## TOOLS MENU

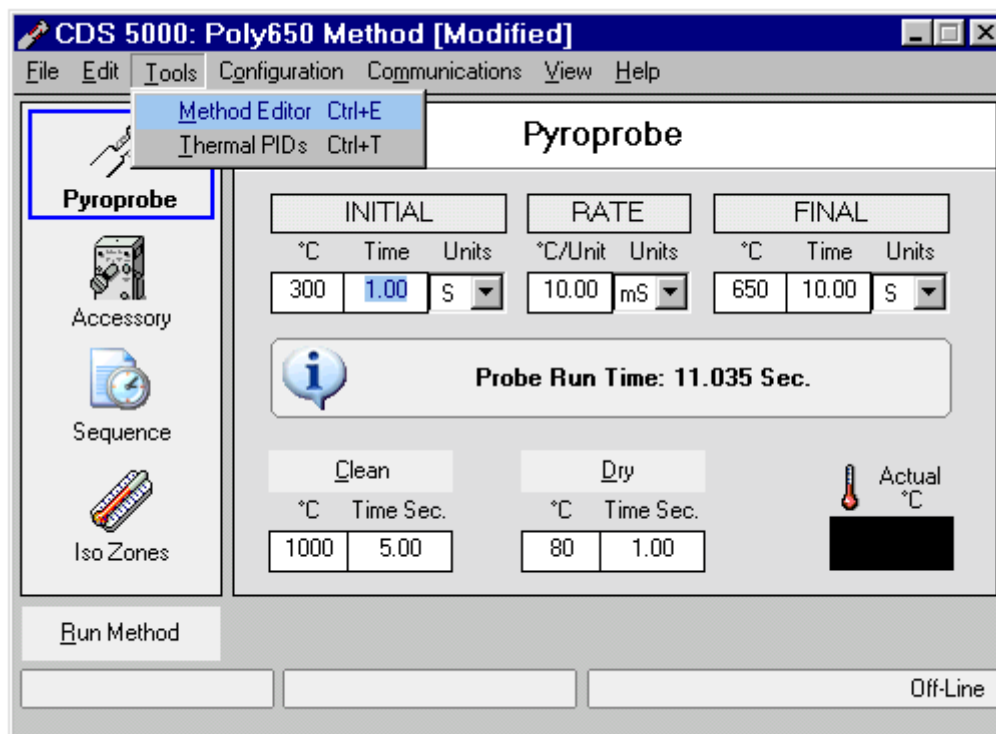

Selecting *TOOLS* from the menu bar provides two selections, the *Method Editor* and access to the *PIDs* for the various heaters. PID values are set for the heaters at the factory and under normal conditions require no adjustment by the user.

The *Method Editor* window presents a screen with all the values needed for a complete method on one page, and is a convenient way to review and revise methods. Methods may be programmed, edited and saved using the editor, which is described in detail on page 4.12.

## CONFIGURATION MENU

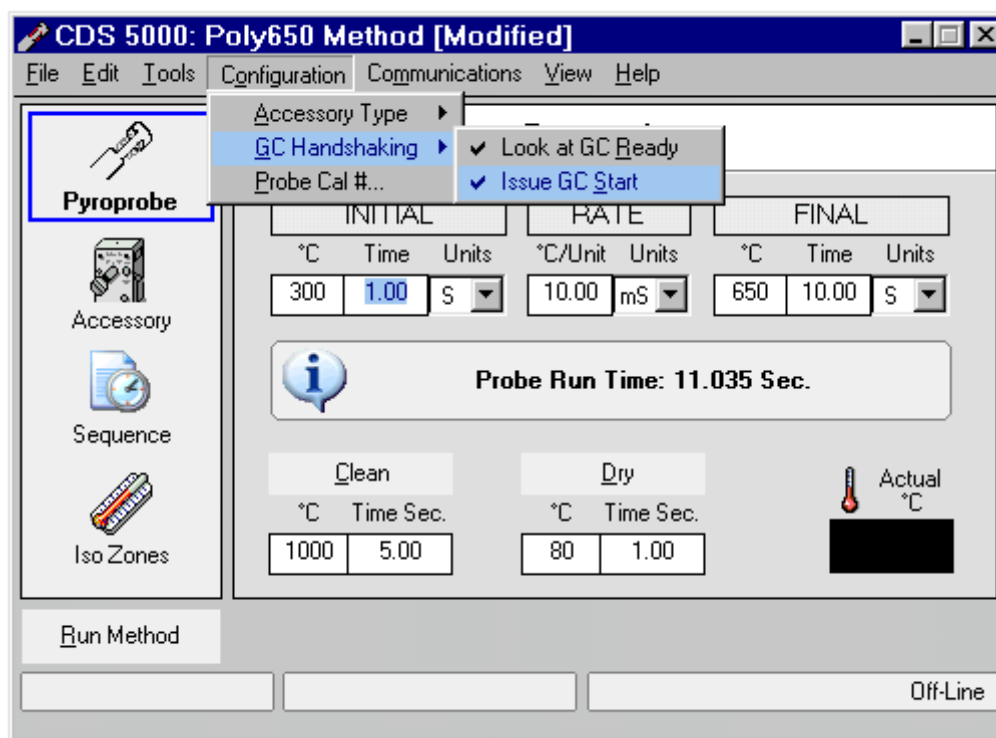

The *Configuration* menu includes selections for *Accessory Type*, *GC Handshaking* and is where the probe *Calibration* number is entered.

Under *Accessory Type*, the selection is between the 1500 interface and the 1550 interface. The Model 5000 is usually used with the standard 1500 interfaces, which is the valved box which is mounted on the GC injector. The Model 5150 uses the 1550 interface, which is the low mass zone located on the 5150 itself, connected to the GC using a transfer line. Although initial, ramp and final zones are presented for each, it is recommended that the 1500 be used isothermally, since the presence of the valve makes the interface mass larger than the 1550 zone of the 5150, making it heat and cool more slowly.

Under *GC Handshaking*, the choices are *Look at GC Ready* and *Issue GC Start*. In most analyses, both of these functions should be checked. This tells the 5000 to wait for a GC ready signal before pyrolyzing the sample, and to Start the GC when the probe fires. These commands may be turned off if the user wishes to start the GC manually, if a ready signal is not available, or if the 5000 is connected to a device other than a GC.

When changing the probe rod, the new calibration number (located on the yellow tag on the rod itself) should be entered by selecting *Probe Cal #* in this menu.

## COMMUNICATIONS MENU

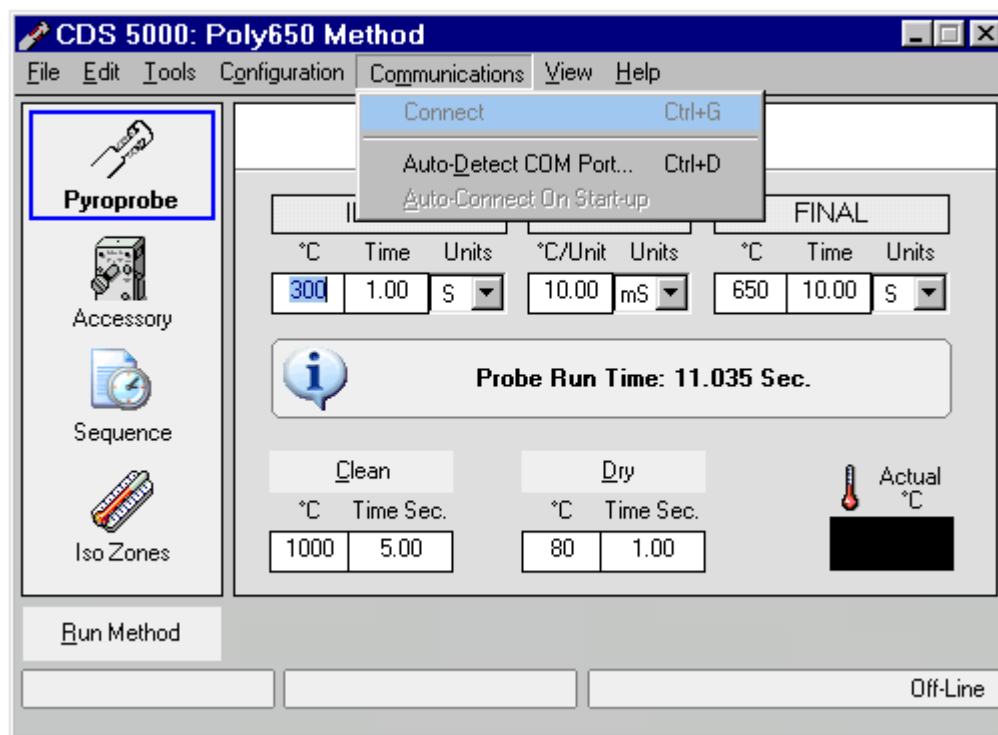

The *Communications* menu provides control of the communication between the PC and the 5000 unit itself. Clicking on the top entry (*Connect*) establishes communication to the 5000, which is confirmed by a tone at the 5000, at which time the top line changes from “Connect” to “Disconnect”.

When installing the 5000, the *Auto Detect COM Port* function may be used to establish the correct com port used on the PC to communicate with the 5000. In addition, the software may be set to connect automatically when the program is opened.

## PROGRAMMING THE PYROPROBE FILAMENT

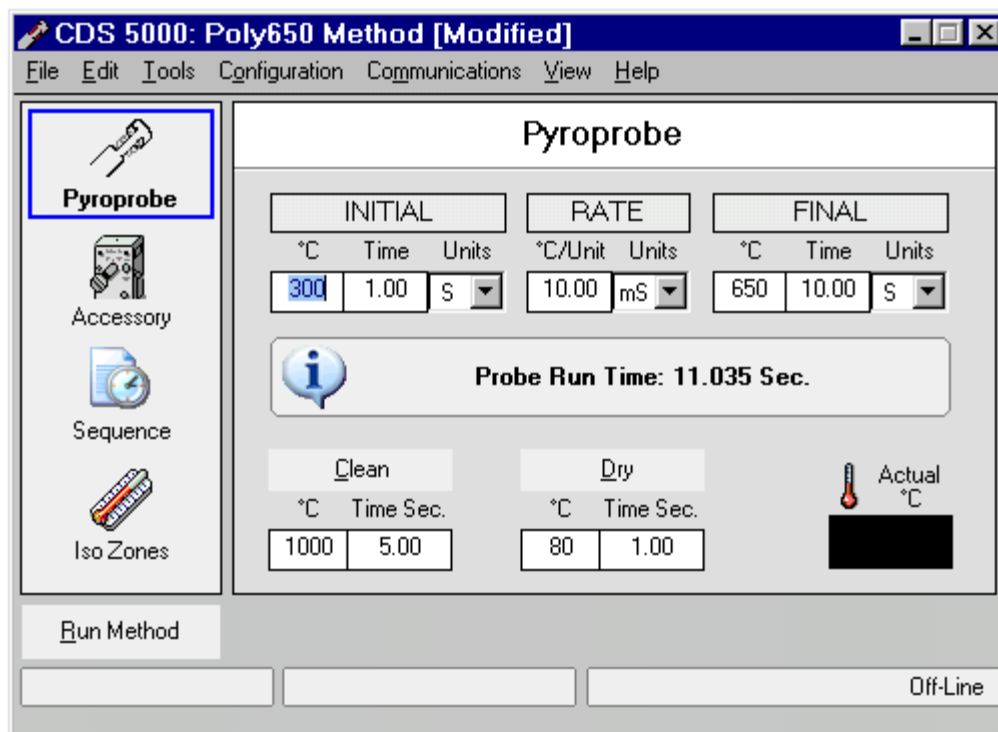

A method includes all parameters for the Pyroprobe filament, the interface zone, the clean and dry functions and the isothermal setpoints. The screens for setting parameters for each function are selected by choosing the appropriate icon on the left-hand side of the window. Selecting *Pyroprobe* presents the screen for entering the initial, rate and final setpoints for the filament itself, plus the clean and dry functions.

The filament initial and final temperatures are set in °C, in 1° increments up to 1400°. Time may be set in seconds or minutes, by selecting either S or MN under UNITS. The heating rate of the filament may be set in °C per minute, second or millisecond. For pulse experiments a value between 10 and 20°C/ms is recommended.

The Pyroprobe filament fires at the start of the Interface or accessory FINAL step. This permits adjusting the interface zone temperature before actually pyrolyzing the sample. Pressing *RUN METHOD* will start the current method, time the interface, then fire the probe and start the GC at the accessory final step.

Clicking on *CLEAN* or *DRY* on this screen will immediately take the Pyroprobe filament to the setpoint temperature for the programmed time for those functions.

Start, Dry and Clean may also be activated by pressing the appropriate key on the front panel of the 5000 unit itself.

## PROGRAMMING THE ACCESSORY (INTERFACE)

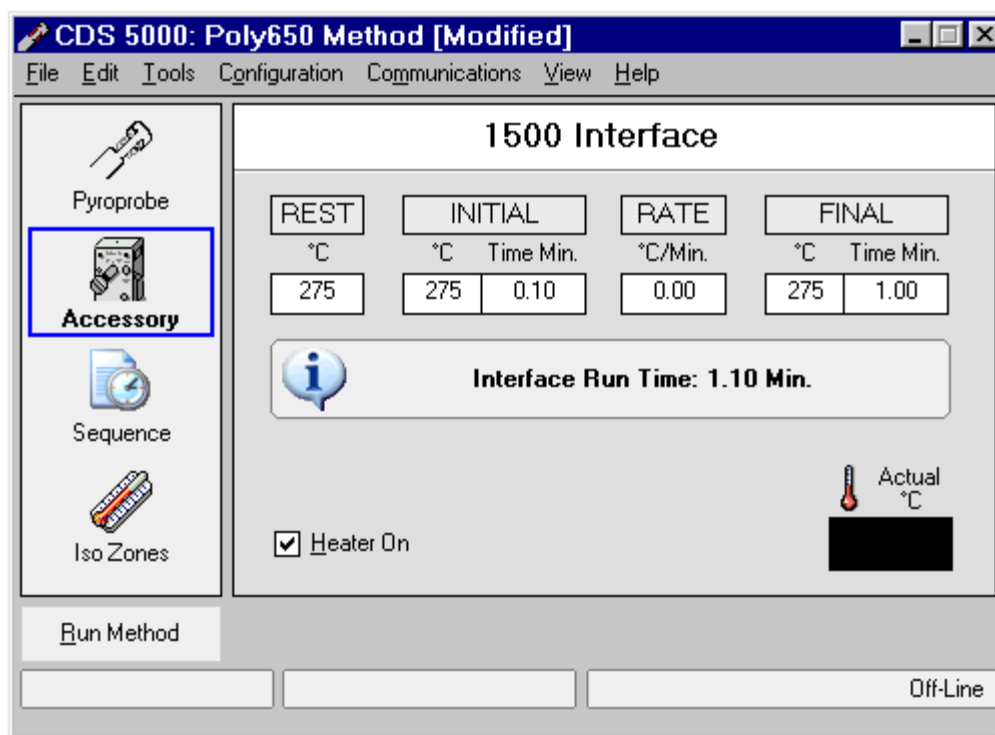

The interface zone for the Pyroprobe is also set in °C, with a maximum of 350°C. To prolong the life of the rotor used in the 1500 valved interface, a maximum extended use temperature of 300°C is recommended.

Since the 1500 interface uses a valve oven to house the probe, it is suggested that this interface be used isothermally. This is done by entering the same value for the initial and final temperatures. As shown above, the interface would stay at 275°C, and when the *Run Method* button is pressed, the probe would fire at the start of the Final step, 0.10 minutes into the run. To make the probe fire immediately, an initial time of 0 may be entered.

The interface has a rest temperature to be used between runs. The Heater On box must be checked to heat the interface, and may be unchecked to cool it without changing the rest temperature value.

The Method may be started by clicking on *Run Method* from this screen or from the Pyroprobe screen.

## PROGRAMMABLE INTERFACE ZONE

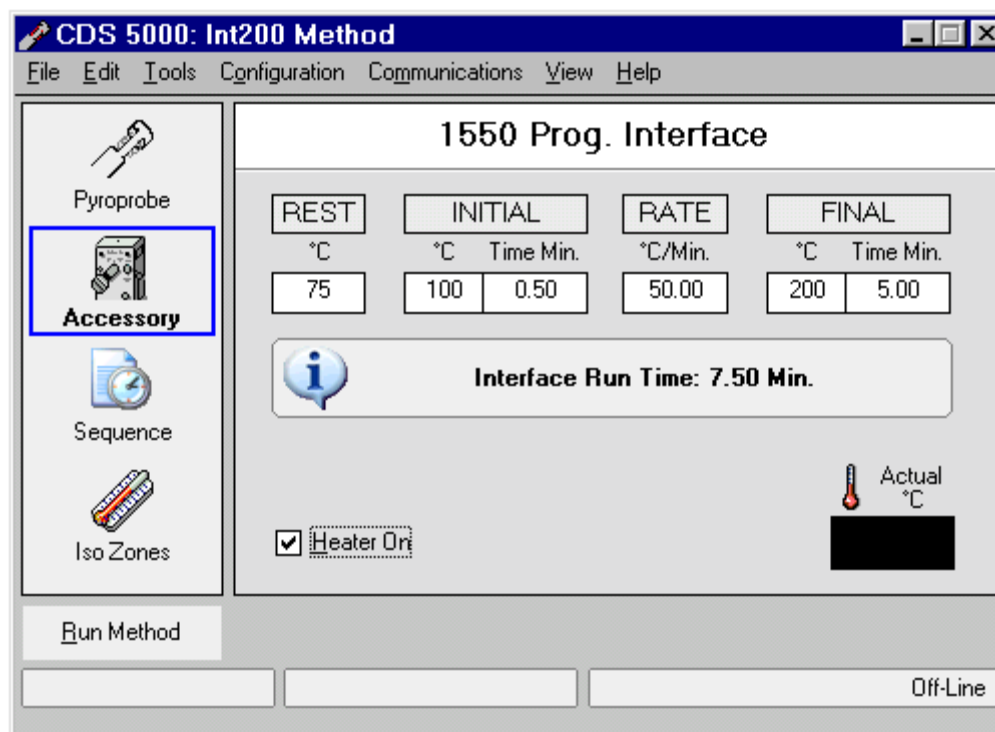

The Pyroprobe 5150 connects to the GC using a heated transfer line and has the valve in an isothermal valve oven, so the interface zone for the probe is low-mass and easily programmable. In the above example, the interface zone rests at 75°C. When *Run Method* is pressed, the zone goes to 100°C, then from 100° to 200° at 50°C/minute. When the interface reaches 200° at the start of the Final step, the probe is fired and the GC started. The interface zone will stay at 200° for five minutes, then return to the 75° rest temperature until the next run.

## CREATING A SEQUENCE OF METHODS

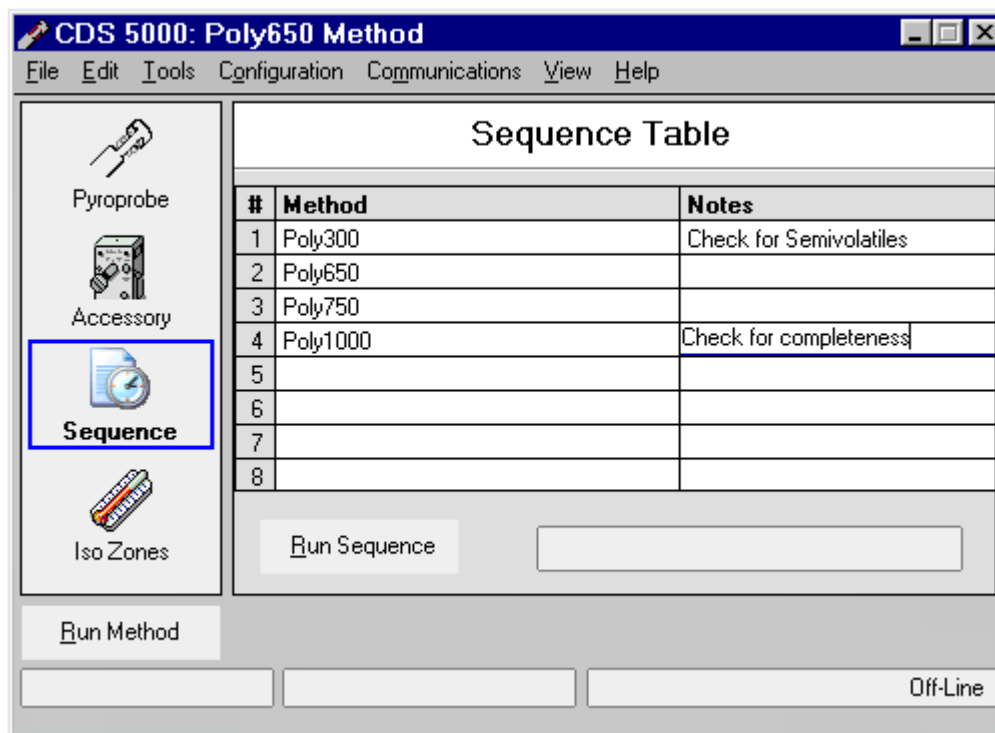

Once a sample has been loaded into the 5000 or 5150, it may be analyzed using several methods sequentially and automatically. Up to eight methods may be used in a sequence, each one with a pyrolysis and interface program, starting the GC each time. The use of the 5150 low-mass interface zone is especially useful in proceeding through a series of temperatures from low to desorb volatiles and semivolatiles to high for pyrolysis.

In the Sequence Table, double-clicking on a numbered line opens the *Select Method* window. Double-clicking any method enters that method with all of its parameters as the method to be run in that step of the sequence. When the complete sequence has been defined, it may be saved as a sequence by selecting *FILE*, then *SAVE*. The sequence will be saved with a name and a .s50 extension. To initiate the whole sequence, the *RUN SEQUENCE* button is pressed from the Sequence screen. In the above example, a sample is sequentially heated to 300°, 650°, 750° and then 1000°C, with a GC run each time. This would provide runs for volatiles and semivolatiles, pyrolysis and then higher temperature runs to evaluate the completeness of the pyrolysis runs.

Saved sequences may be opened by selecting *FILE*, then *OPEN A SEQUENCE*. It is important to be sure that the GC is also programmed with a sequence so that each run will be saved and a GC Ready signal will be sent to the 5000, so that it may go to the next method.

## SETTING ISOTHERMAL TEMPERATURES

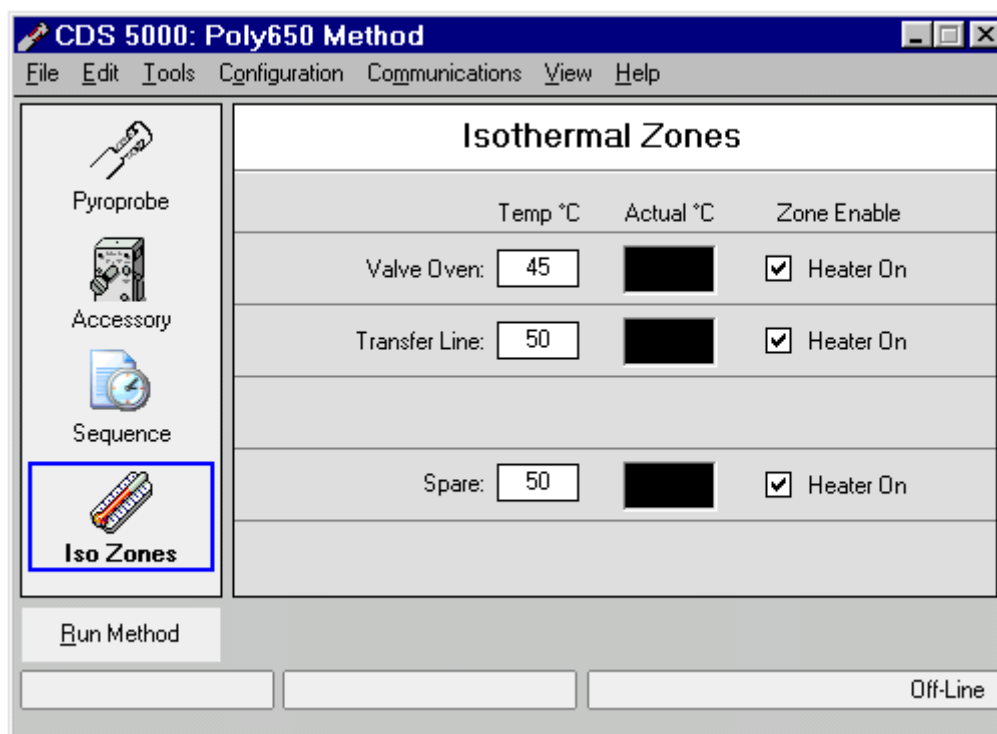

The Pyroprobe is capable of controlling up to four isothermal zones. For the 5150, two of these are pre-set as the valve oven (for the on-line/off-line valve) and the heated transfer line to the GC. These values are saved as part of the method. Each zone may be turned on or off by checking the *Heater On* box displayed in the *Iso Zones* screen.

## METHOD EDITOR

Method Name: * Untitled *			
Probe Initial Temp.	0	°C	
Probe Initial Time	0.00	S	
Probe Ramp Rate	0.00	°C/ mS	
Probe Final Temp.	0	°C	
Probe Final Time	0.00	S	
Probe Clean Temp.	0	°C	
Probe Clean Time	0.00	Seconds	
Probe Dry Temp.	0	°C	
Probe Dry Time	0.00	Seconds	
Interface Rest	0	°C	<input checked="" type="checkbox"/> ON
Interface Initial Temp.	0	°C	
Interface Initial Time	0.00	Minutes	
Interface Ramp Rate	0.00	°C/Minute	
Interface Final Temp.	0	°C	
Interface Final Time	0.00	Minutes	
Valve Oven Temp.	0	°C	<input type="checkbox"/> ON
Transfer Line Temp.	0	°C	<input type="checkbox"/> ON
Auxiliary #1 Temp.	0	°C	<input type="checkbox"/> ON
Spare Temp.	0	°C	<input type="checkbox"/> ON

Minimum: 0°C  
Maximum: 1400°C

Selecting *Method Editor* under the *Tools* menu presents the screen shown above. This Method Editor page permits entering all the setpoints for all parameters needed for a complete method. Using the *File* menu from this page permits opening, saving, saving as, and so on as for other screens. This is a convenient page for both preparing a complete method and for reviewing all of the parameters that are saved as an existing method.

## **SECTION 5. CDS PYROPROBE GC INTERFACING**



### **MODEL 1500 GC INTERFACE INTRODUCTION**

The CDS Analytical Pyroprobe 1500 is a valved interface which connects the CDS Pyroprobe to the inlet of a gas chromatograph. The 1500 includes a valve which permits the user to place the pyrolysis zone on-line or off-line from the GC injection port. This allows the user to insert and remove the probe while the GC oven is programming, without disturbing the GC column flow. With the valve in the LOAD or OFF-LINE position, GC carrier goes directly to the injection port, bypassing the Pyroprobe entirely. The 1500 includes a separate interface purge flow which purges the interface zone to vent when the 1500 is off-line from the GC. When the 1500 is placed in the RUN or ON-LINE position, GC carrier is directed through the interface zone to sweep the pyrolysate onto the GC column.

The 1500 is compatible with packed, wide-bore and narrow-bore capillary columns. When performing split capillary analysis, the GC injection port pneumatics are used in the standard way, that is, the injection port pressure or flow and the split flow are all set using the GC injection port controls as usual.

The temperature of the pyrolysis interface zone and the valve are controlled by the interface heater control of the Pyroprobe controller. The 1500 connects to the Pyroprobe 5000 controller by use of a round 7-pin connector, and the setpoint and actual temperatures are displayed on the Pyroprobe control software Accessory screen.

### **DESCRIPTION**

The CDS 1500 Pyroprobe interface is designed to sit directly above the injection port of the gas chromatograph, with flow to the GC exiting the bottom of the 1500. With the 1500 oriented so that the probe enters the front, pneumatic connections and the valve rotation knob are found on the left side of the interface, which includes two bulkheads for flow connection, the valve knob and a vent. The two bulkheads are for bringing in GC carrier gas to the valve oven and interface purge flow. The GC carrier always exits the interface to the injection port, regardless of the valve position, and the purge flow always exits the vent. The electrical cable to connect the 1500 to the Pyroprobe controller is found on the rear of the interface.

Both the valve and the pyrolysis zone are located inside a heated valve oven which is controlled by the Pyroprobe accessory heater control. Therefore, there is only one connector to attach to the Pyroprobe controller, and the temperature for the Pyroprobe interface and the valve are the same.

As with any pyrolysis interface, the 1500 must be inserted pneumatically into the carrier stream of the GC. This requires connection of the GC carrier to the inlet bulkhead of the 1500 instead of directly to the injection port of the GC. In addition, another flow, the interface purge, is connected to permit purging the interface before placing it on-line with the column, and baking the interface to vent between runs. A "T" fitting and metering valve are provided to permit the user to add this purge flow to the system.

When properly connected, the left side of the 1500 interface looks like the diagram in the figure below.

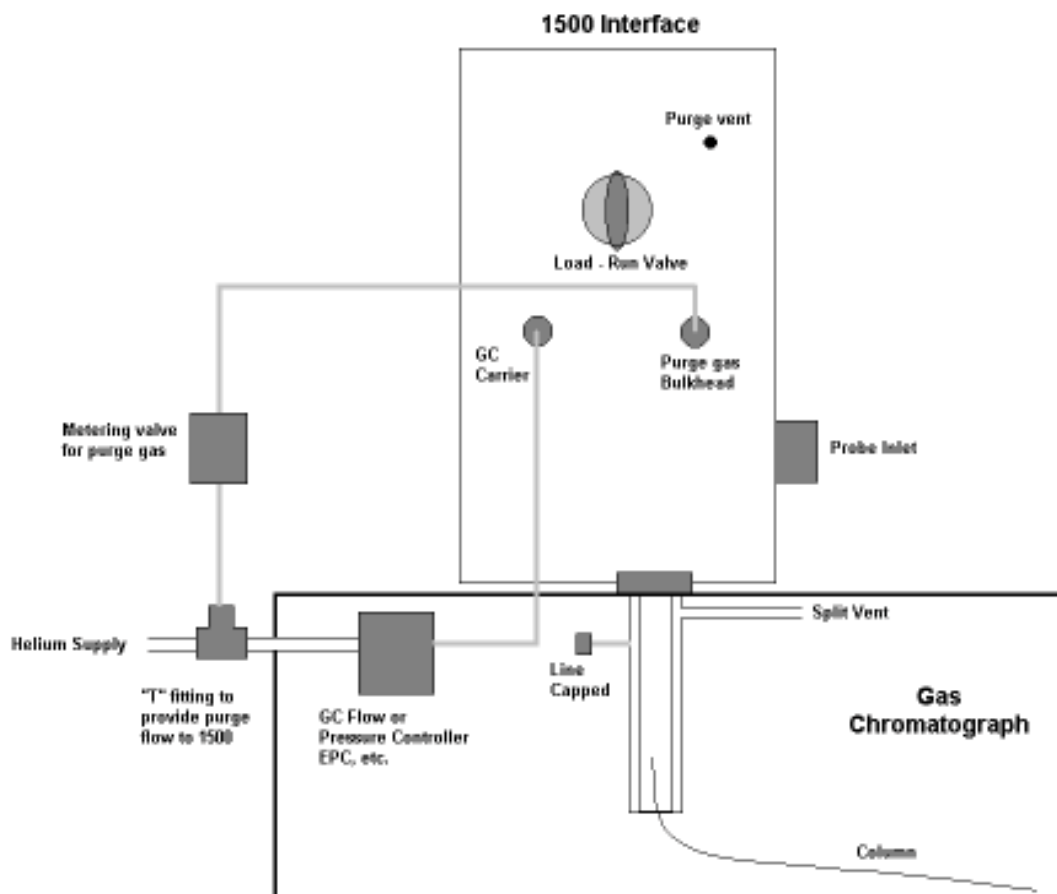

**FIGURE 5.1.** 1500 interface diagram.

## INSTALLATION

To transfer the pyrolysis products for analysis, the 1500 Interface must be connected pneumatically to the gas chromatograph. This requires disconnecting the GC carrier flow into the injection port and connecting it instead to the 1500 interface. The inlet to the injection port must be capped to prevent all flow from leaking out where the carrier was disconnected. For convenience, a diverter valve may be installed to permit directing the GC flow either to the 1500 interface or back to the injection port (see page 5.9).

When the 1500 is installed, the GC carrier flow is connected to the on-line, off-line valve, which permits directing flow either to the interface zone of the Pyroprobe and then to the GC, or straight to the injection port (in the Load position).

Flow is connected from the valve to the injection port using a union inside the valve oven of the 1500, which connects to a tubing assembly held in place by the GC septum retainer. This permits positioning of the 1500 close to the injection port and the elimination of a cold spot. The union inside the 1500 attaches to a piece of 1/8" stainless steel tubing which is connected to the injection port by the septum retainer, as shown in the diagram on the next page. All flow into the GC injection port goes through this 1/8" tubing, whether the system is being used split or not. The capillary GC column is brought up through the injection port and into this 1/8" tube. In operation, the carrier flow which exits the splitter vent goes through the tube around the outside of the capillary column, into the injection port and out the split vent while the analytical flow goes through the capillary column. Alternatively, the 1500 interface may be installed using a traditional needle assembly. In this case, flow goes through the septum via a needle, and the GC column is left installed in the injector as for standard syringe injections.

## MOUNTING TRAY

On some models of gas chromatographs, the tray around the injection ports is too small to accommodate the 1500 interface. Mounting the 1500 above the tray would produce a cold spot between the interface and the injection port. To eliminate this problem, CDS Analytical provides a replacement tray designed with a larger area to permit installation of the interface directly on top of the injection port. When installing the 1500 therefore, the existing injection port tray should be removed from the GC and replaced with the new one supplied by CDS Analytical.

The 1500 is mounted onto the tray using three alignment pins - two on the left or valve knob side and one on the right side. The interface fits down over the two pins on the left side, and the single pin on the right screws into the tray through the cabinet of the 1500 as a locking pin. The replacement tray includes multiple positions for the alignment pins so that the 1500 may be installed in three orientations - with the probe entering from the front (A) or from the left side (B) on the front injection port, or from the left side (C) on the rear injection port. The replacement tray is shown on page 5.6, which also shows the placement of the alignment pins used to place the 1500 in position A, B or C. On the diagram, the locking pin is designated with the letter L, so for position A, pins would be placed in two holes marked A and the locking pin in the position marked AL.

**CDS ANALYTICAL 1500 INSTALLED ON GC INJECTION PORT**  
Schematic as seen from the right, with probe inlet (front) to the left.

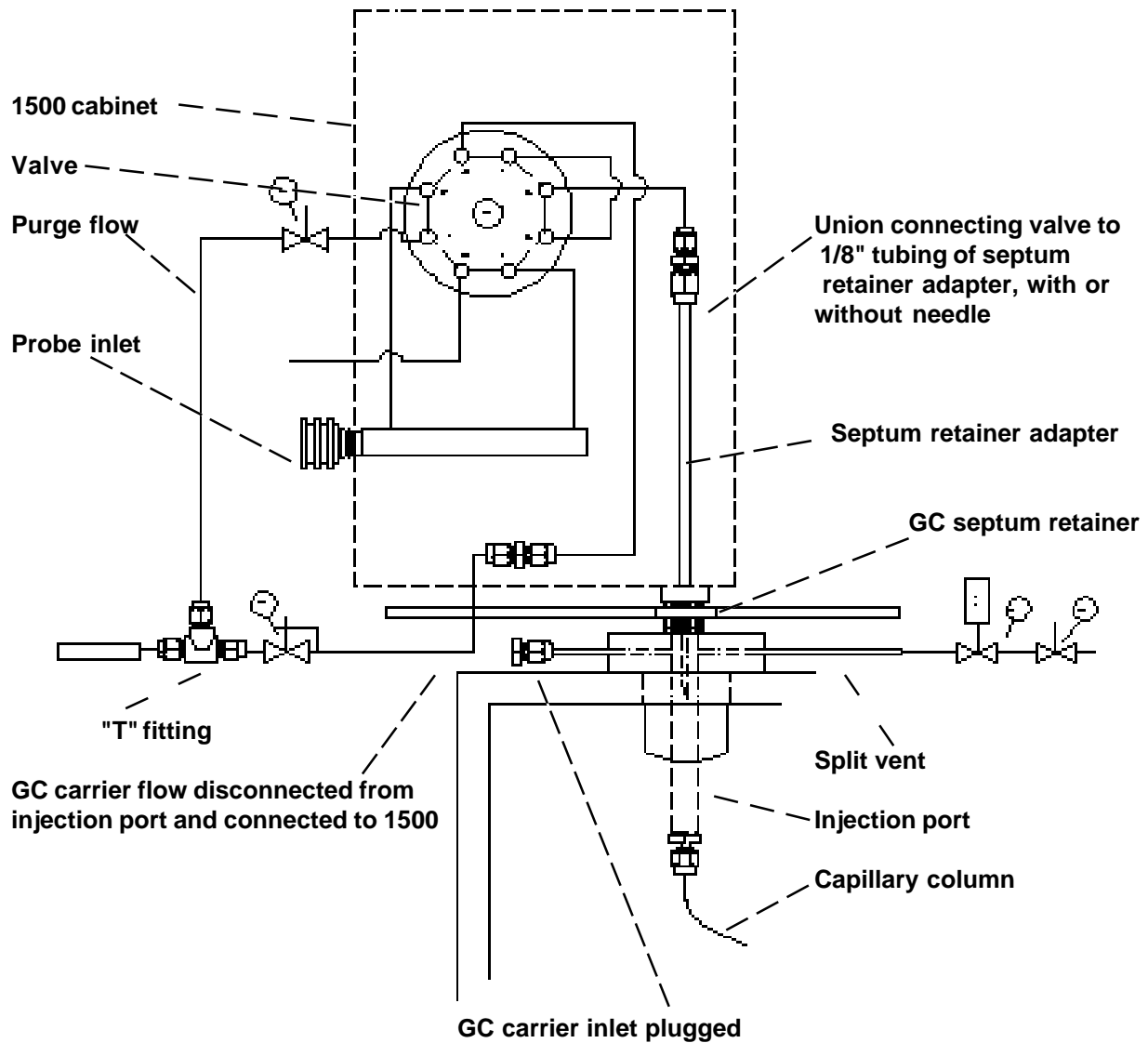

**FIGURE 5.2.** Pneumatic configuration.

## INSTALLATION INSTRUCTIONS

### Warning

**BOTH THE GAS CHROMATOGRAPH INJECTION PORT AND THE PYROPROBE INTERFACE ARE HOT WHEN IN USE. ALLOW THESE PARTS TO COOL BEFORE HANDLING, INSTALLING OR REMOVING INTERFACE.**

Installing the 1500 interface involves three steps:

- A. Bringing GC carrier flow into the 1500 instead of directly to the injection port;
- B. Adding the adapter to the septum retainer; and
- C. Connecting the 1500 to the septum retainer adapter.

#### **A. GC Carrier Flow**

1. Disconnect the tubing which goes from the helium filter to the carrier IN position of the injection port.
2. Cap the end of the tubing connected to the injection port so that flow will not exit here instead of going to the column. Be sure to use a Vespel ferrule at this plug so that it may be removed later if it is desired to restore the GC pneumatics to their original configuration. Alternatively, installing a diverter valve permits switching between the 1500 and using the injection port as usual, as shown on page 5.9.
3. Attach the 1/16" tubing provided to the outlet fitting of the helium filter.
4. Attach the other end of this tubing to the bulkhead on the 1500 marked Carrier IN. Now the GC flow or pressure controller is supplying flow into the 1500 instead of into the injection port of the GC.
5. Install the "T" fitting provided in the helium inlet line to provide purge flow for the 1500.
6. Connect one leg of the "T" to the original helium inlet for the GC to maintain flow for the GC pneumatics.
7. Connect the tubing for the purge flow metering valve to the other leg of the "T".
8. Connect the tubing out from the purge flow metering valve to the 1500 bulkhead fitting marked purge in and secure the metering valve with the supplied bracket to a convenient position.

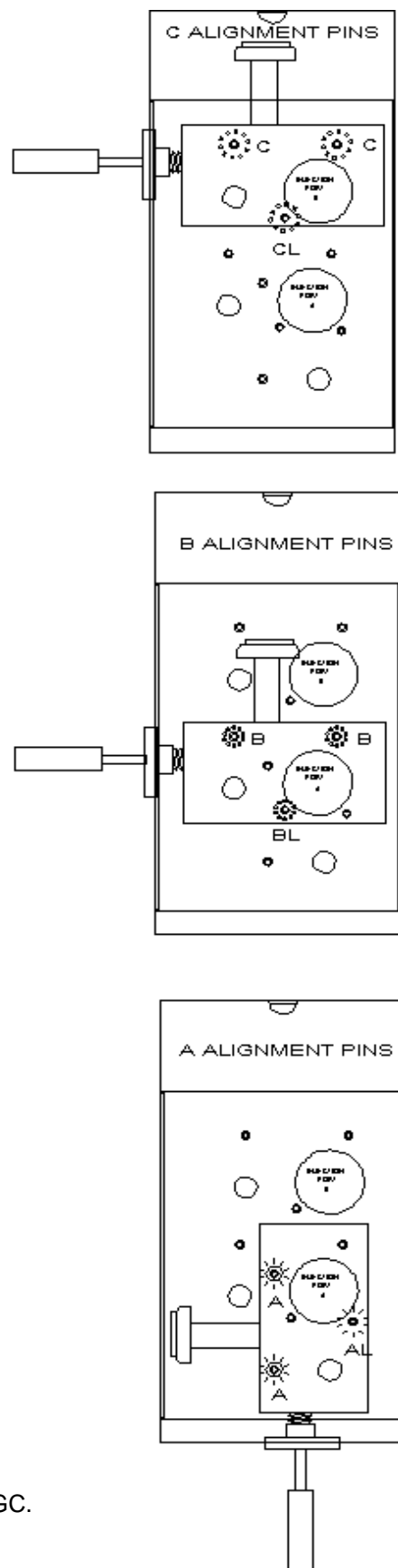
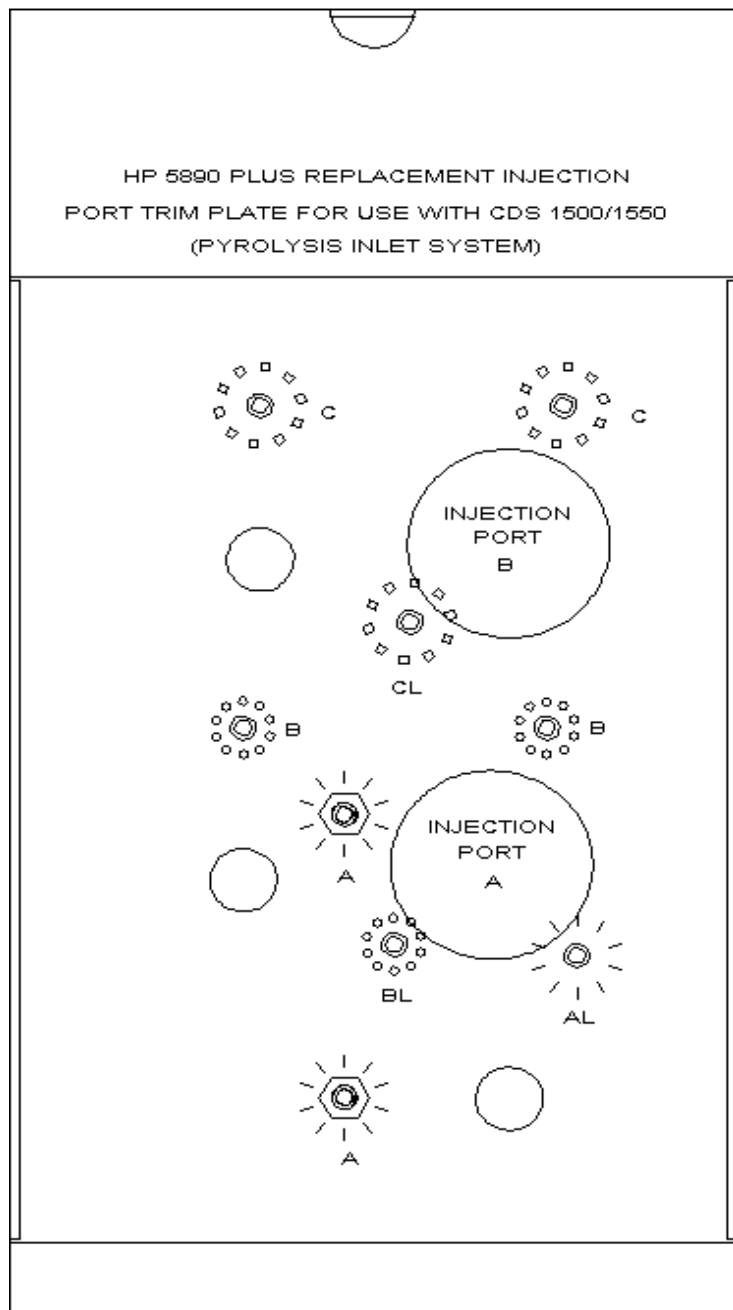
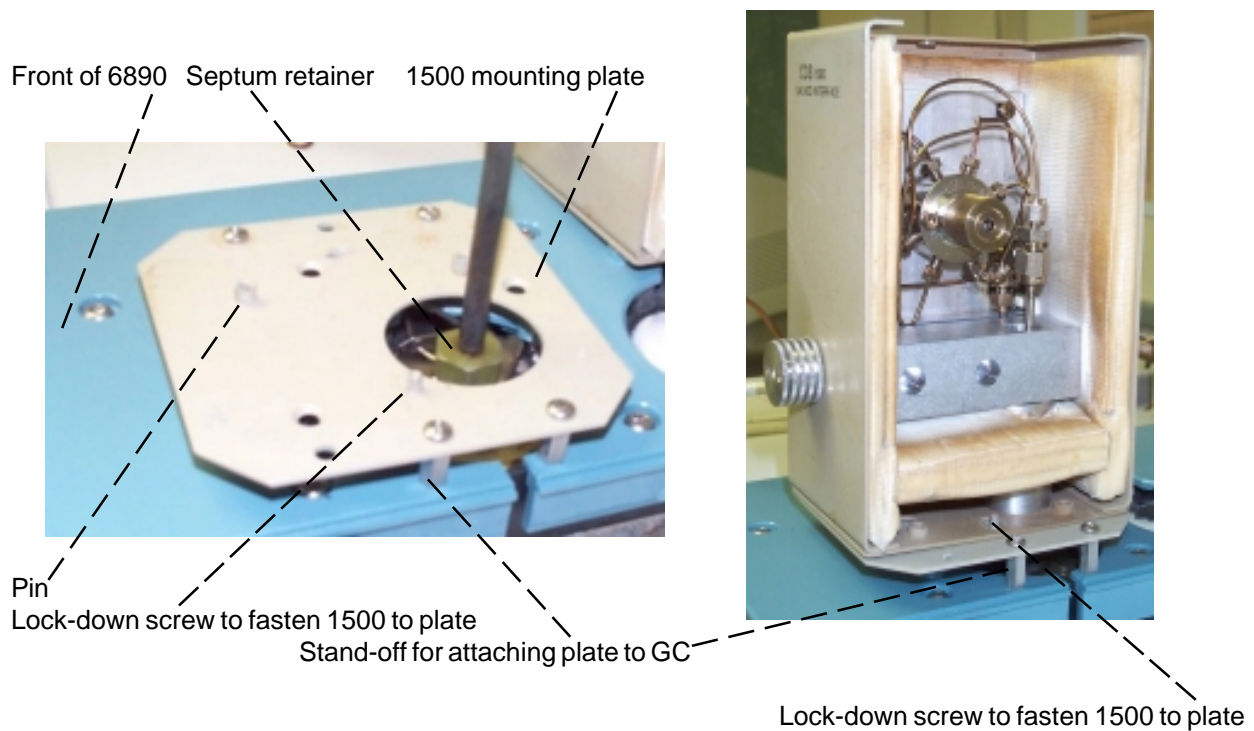

FIGURE 5.3. Mounting for 5890GC.

## MOUNTING PLATE FOR AGILENT 6890

The mounting plate for the Agilent 6890 gas chromatograph attaches to the top tray directly, using stand-off screws as shown in Figure 5.4. The circular cutout for the septum retainer adapter should be placed directly over the septum retainer of the injection port to be used. The mounting plate has two pins and a lock-down screw for stabilizing the 1500 during use. After the mounting plate has been attached to the GC with the pins and lock-down screw facing up, the 1500 is positioned on top of the plate as shown in Figure 5.4. The pins align with two holes in the base of the 1500 itself, and the lock-down screw projects through a hole on the right side of the base, inside the insulated cover. The 1500 is stabilized by attaching a nut to the lock-down screw, securing it to the mounting plate.

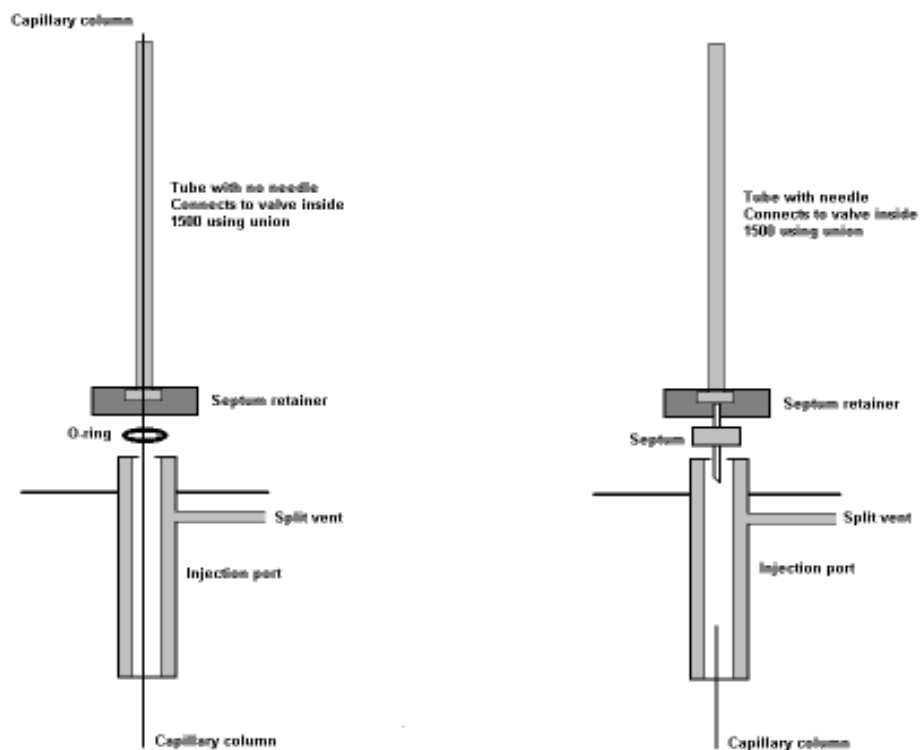

**FIGURE 5.4.** Mounting for Agilent 6890 GC.

## **B. Adapting the septum retainer**

1. Remove the septum retainer and septum from the injection port.
2. Insert the 1/8" tubing of the septum retainer adapter through the septum retainer so that it protrudes above the top. It may be necessary to enlarge the needle hole in the septum retainer using a 1/8" drill bit to permit passing the tubing through. All of the tubing should be above the septum retainer so that the flat disk at the bottom of the adapter contacts the inside of the septum retainer.
3. Place an o-ring against the flat disk of the adapter so that it is sealed into the injection port septum well with the adapter on top of it, held in place by the septum retainer, as shown in the diagram below. The 1/8" tubing will protrude up from the injection port, and the 1500 will be attached to the injection port using this tubing.

NOTE: The 1500 interface may be installed using a needle assembly instead of the tube with no needle. For this installation, the fitting from the valve still connects to the top of the 1/8" tubing, but a septum is used with the needle instead of an o-ring. (see figure on page 5.4)



**FIGURE 5.5.**

### **C. Connecting the 1500**

1. Decide which orientation (A, B or C) will be used, and screw in the two alignment pins for the valve knob side of the 1500.
2. Remove the top cover of the 1500 and place the interface over the two alignment pins so that the 1/8" tubing of the septum retainer adapter passes through the channel and into the valve area of the 1500.
3. Screw in the third alignment pin, through the corresponding hole in the base of the 1500, locking the 1500 into place on the mounting tray.
4. If it has not yet been done, attach the carrier flow and purge flow to the corresponding bulkhead fittings on the 1500.
5. Remove the insulation covering the valve area of the 1500. Bring the inlet of the capillary column up through the injection port (removing the liner if necessary) and through the adapter tubing so that it is even with the end of the tubing.
6. Attach the 1/16" tubing from the valve to the adapter tubing using the reducing union provided.
7. Replace the insulation covering the valve, then the cover, securing it with the screw at the top.
8. Plug the electrical connection for the 1500 into the interface heater position on the back of the Pyroprobe controller.

### **OPERATION**

With the 1500 installed, the Pyroprobe filament rod is inserted into the probe inlet and sealed in place with the seal in the probe collar.

It is recommended to keep the valve in the OFF-LINE or LOAD position except when actually making a run. This keeps flow going directly to the injection port, and therefore the column, while purging the interface area to vent. After a sample has been placed on the ribbon or inside the coil, insert the probe into the probe inlet and seal. Allow a short time for the air in the system to be purged out the vent, then turn the valve to the ON-LINE or RUN position. Now the probe is on-line with the GC column. When the Pyroprobe START key is pressed, the sample is pyrolyzed, and the pyrolysate is carried through the valve to the column inlet, and onto the column. After the sample has been pyrolyzed, the valve may be turned to the OFF-LINE position and the probe removed for cleaning and preparing the next sample.

## INSTALLATION WITH DIVERTER

The installation of a diverter valve on the GC carrier flow line simplifies converting the GC from use with the Pyroprobe interface back to the standard injection port. As shown below, the carrier gas may be directed to the interface in one position of the diverter valve, or back to the injection port in the other direction. Converting the GC back to standard operation, then, only requires removing the interface needle adapter, replacing the standard injection port septum retainer, and turning the diverter valve to the GC direction.

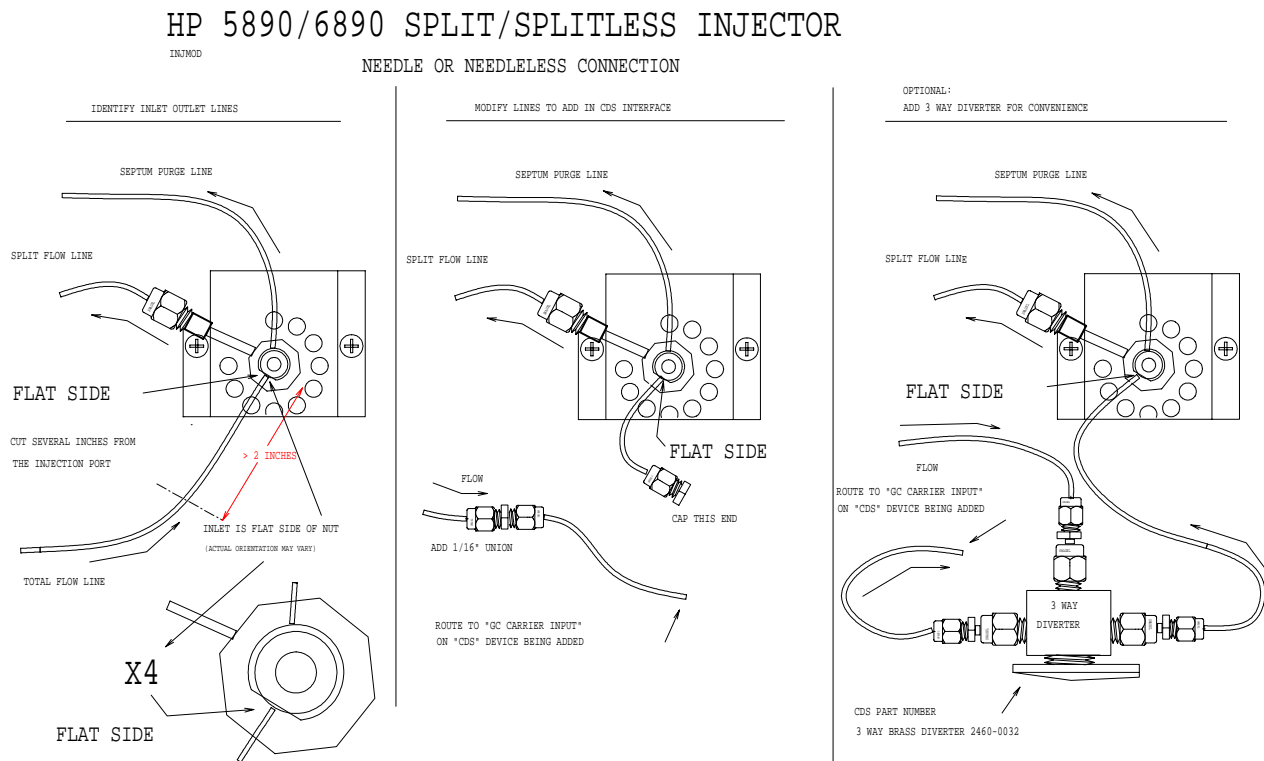

**FIGURE 5.6.**

## INSERTS AND LINERS

### Glass Insert Tube

It is not necessary to remove the 1500 interface from the GC to make syringe injections of liquid standards. The 1500 comes equipped with a septum retainer which attaches to the probe inlet for this purpose. To reduce dead volume in the 1500 interface when making syringe injections, a glass insert is placed into the interface (instead of the Pyroprobe) and the opening is capped with the septum retainer. This glass insert is thick-walled, with just a narrow passage in the center for the syringe needle. As with pyrolysis, the valve must be in the RUN position when making syringe injections to the GC.

## **PYROPROBE 5150 INTERFACING HEATED TRANSFER LINE**

The Pyroprobe Model 5150 incorporates a low mass, programmable interface zone for the probe into the body of the Pyroprobe itself. The on-line/off-line valve is housed in a separate valve oven, also part of the 5150 unit. Connection to the gas chromatograph is made via a heated transfer line. The valve oven and the transfer line are separate isothermal zones controlled through the isothermal window of the Pyroprobe control software, while the interface zone for the probe is programmable and is controlled using the accessory programming window of the Pyroprobe.

The on-line/off-line valve of the 5150 is controlled automatically by the Pyroprobe. The sample is placed on-line with the GC during the interface (accessory) FINAL step. This permits pre-treatment of the sample to vent during the initial step, if desired. To have the sample pyrolyzed without pre-treatment, simply enter the same temperature for both the initial and final steps of the accessory, with a 0 time for the initial. In this case, the Pyroprobe will go directly into Accessory Final, rotate the valve and fire the probe. To permit equilibration of the GC carrier gas, there is a 10 second delay after rotating the valve before the Pyroprobe filament is heated. The GC start signal is sent when the probe is heated.

Connection to the GC is made using a heated transfer line which terminates with a needle which is simply inserted through the septum of the GC. The end of the transfer line is recessed so that the heated line covers the injection port septum retainer to eliminate a cold spot. The end of the transfer line at the GC may be stabilized using the transfer line stabilizer as shown in Figure 5.8.

As with the 1500 interface, the 5150 requires connection of the GC carrier gas to the valve oven of the Pyroprobe to transfer the pyrolysate from the probe to the GC injector (see Figure 5.6 on page 5.10, and Figure 5.7). A separate connection is provided for purge gas, which is controlled by the flow controller on the front of the 5150, and purges the interface zone to vent when the unit is off-line.

## INSTALLATION

1. Install the Swagelok diverter as shown in Figure 5.6 on Page 5.10.
2. Connect the GC Carrier from the diverter to the 1/16 inch bulkhead on the side of the 5150 marked **GC**, shown in Figure 5.7.
3. Connect a supply of purge gas (Helium, 100 psi maximum) to the 1/16 inch bulkhead marked **Purge** on the side of the 5150.
4. Attach the 5150 end of the transfer line inside the valve oven of the 5150 using the 1/16 inch Swagelok nut, a graphite ferrule and the bulkhead fitting on the L-bracket to the left of the valve.
5. Pass the GC end of the transfer line (with the needle) through the stabilizer and insert the needle through the septum of the GC (Figure 5.8).

*CAUTION! The needle is permanently attached and sharp. Handle carefully.*

6. Slide the GC end of the transfer line all the way down so that the recessed cup fits over the septum retainer.

GC flow and pressure are adjusted at the GC as for any other analysis. The 5150 is just inserted as a sample delivery loop upstream of the column. Purge gas should be set with the flow controller to 10 - 20 ml/minute, measured at the vent on the front of the 5150.

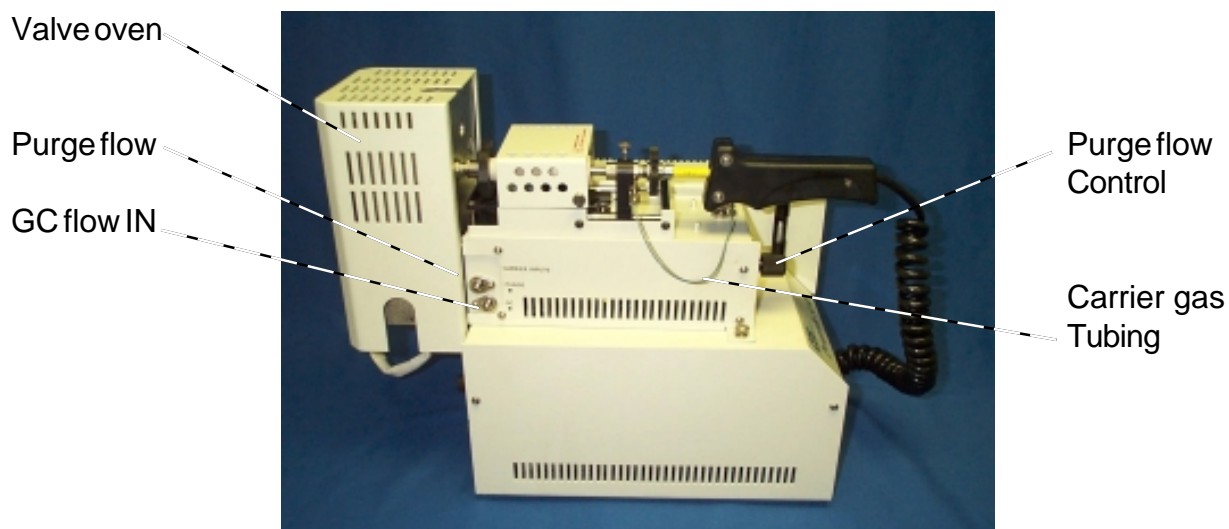

**FIGURE 5.7.** Pyroprobe 5150, side view.

## ELECTRICAL CONNECTIONS

Electrical connections to the 5150 are made on the rear of the unit, as shown in Figure 5.9. The valve oven and transfer lines must be plugged into the corresponding sockets. Remote start connections are made at the upper connector. The serial cable from the computer to the 5150 attaches to the right of the main power switch. The main power fuse for the unit is located inside of the power entry module. On the right hand side of the 5150 rear panel is an additional fuse for the supply voltage of the filament itself.

### Replacing Fuses

The fuse holder of the power entry module is removed by opening the black cover of the module, which is hinged at the bottom (see Figure 5.10). The fuses slide into the sides of the fuse holder, which is then reinserted into the cavity of the entry module. The correct voltage (115 V or 230V) must show through the opening in the black cover when the fuse holder is in place.

**CAUTION:** *Disconnect the instrument from its power source before removing the cover for access to fuses.*

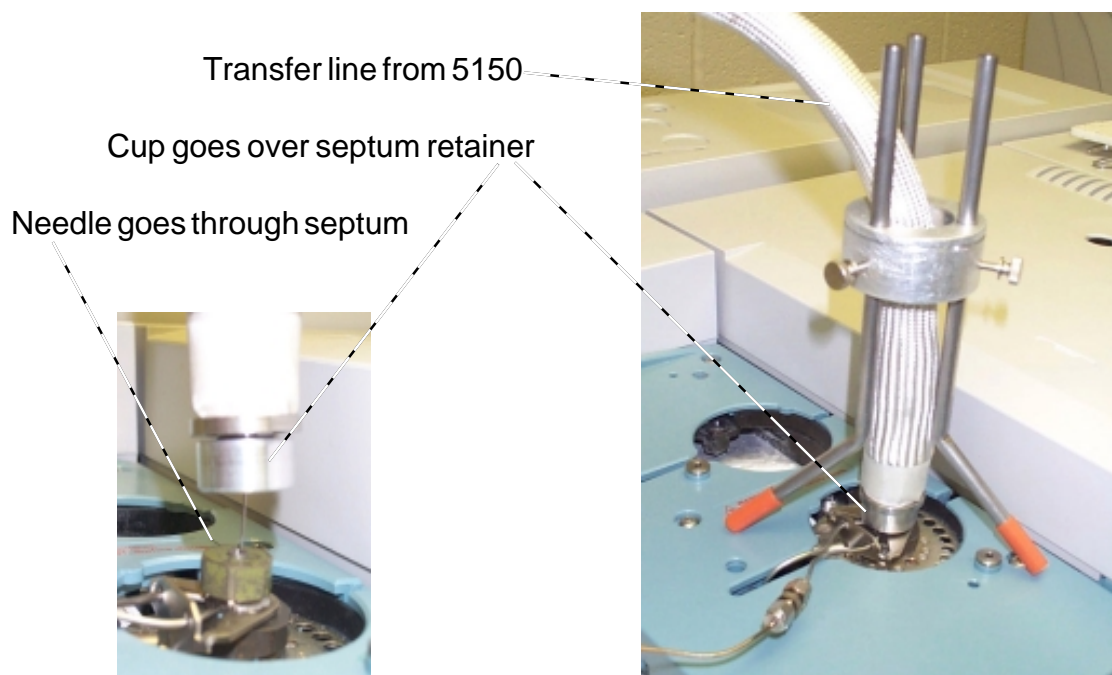

**FIGURE 5.8.** Heated transfer line at GC injection port.

Remote I/O  
For remote start

Transfer line

Valve oven

Computer connection

Power entry  
With main fuse

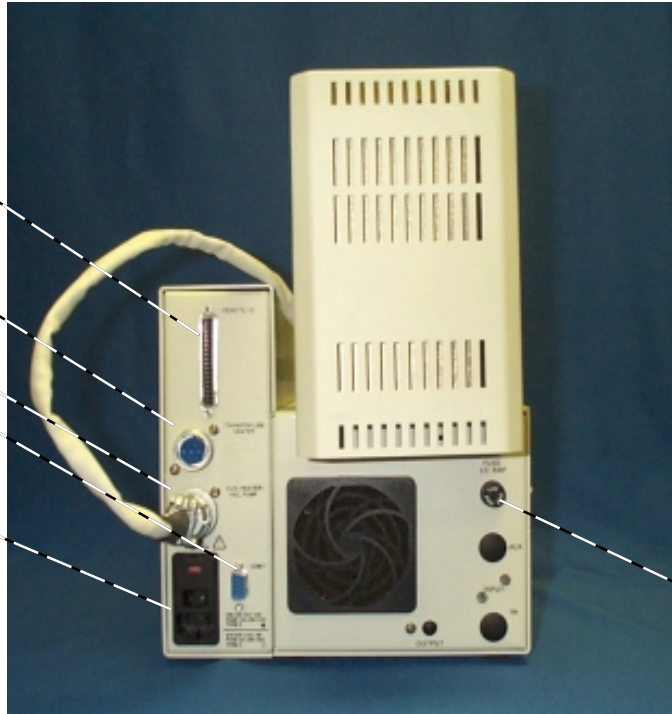

Fuse for  
Filament  
Supply

**FIGURE 5.9.** Rear of 5150.



Cover, opens from the top



Fuse holder

Fuse

**FIGURE 5.10.** Fuse holder in power entry module.

## **SECTION 6. ALTERNATIVE PROBES**

DIRECT INSERTION PROBES (DIP)  
FOR MASS SPECTROMETRY

THERMOCOUPLE PROBES

1/2 INCH PROTECTED COIL PROBE



### **DIRECT INSERTION PROBES FOR MASS SPECTROMETERS**

The Pyroprobe may be used to provide direct Pyrolysis-Mass Spectrometry by using a direct insertion probe. The DIP is made as a direct replacement for the solids probe supplied by the MS manufacturer, and is only available for mass spectrometers which have a solids probe port. In use, the Pyroprobe controls the sample temperature while it is inserted into the mass spec, permitting rapid heating to elevated temperatures as well as slow, programmed heating to study the thermal behavior of materials.

DIPs are available only in coil models, and exact information regarding the make and model of the mass spectrometer is essential to insure compatibility.

**PYROPROBE 5000 LEAD CONNECTIONS FOR DIRECT INSERTION PROBE****Warning**

THE PYROPROBE MUST BE UNPLUGGED BEFORE ATTEMPTING TO MAKE ANY ELECTRICAL CONNECTIONS SUCH AS REPLACING THE PROBE FILAMENT.

**Caution**

PROBE FILAMENTS ARE MADE OF PLATINUM WHICH IS EASILY DAMAGED. DO NOT TOUCH THE FILAMENT WHILE REPLACING THE PROBE ROD.

The direct insertion probe for the Pyroprobe terminates in one connector which is attached to both the red and black wires in the handle, and a return strap which is connected to the combined green and white wires. When changing from a standard (GC or FT-IR) probe to a direct insertion probe for MS work, the red and black wires must be connected together at the center fitting in the handle, before attaching the probe, as shown in drawing 1 below. Alternatively, the connections may be made using the jumper supplied, as shown in drawing 2. In addition, the ballast resistor located inside the control module must be changed according to the directions on page 6.5.

When changing from a direct insertion probe to a standard GC or FT-IR probe, the red wire must be moved to the top connector in the handle, as shown in the drawing on page 6.3.

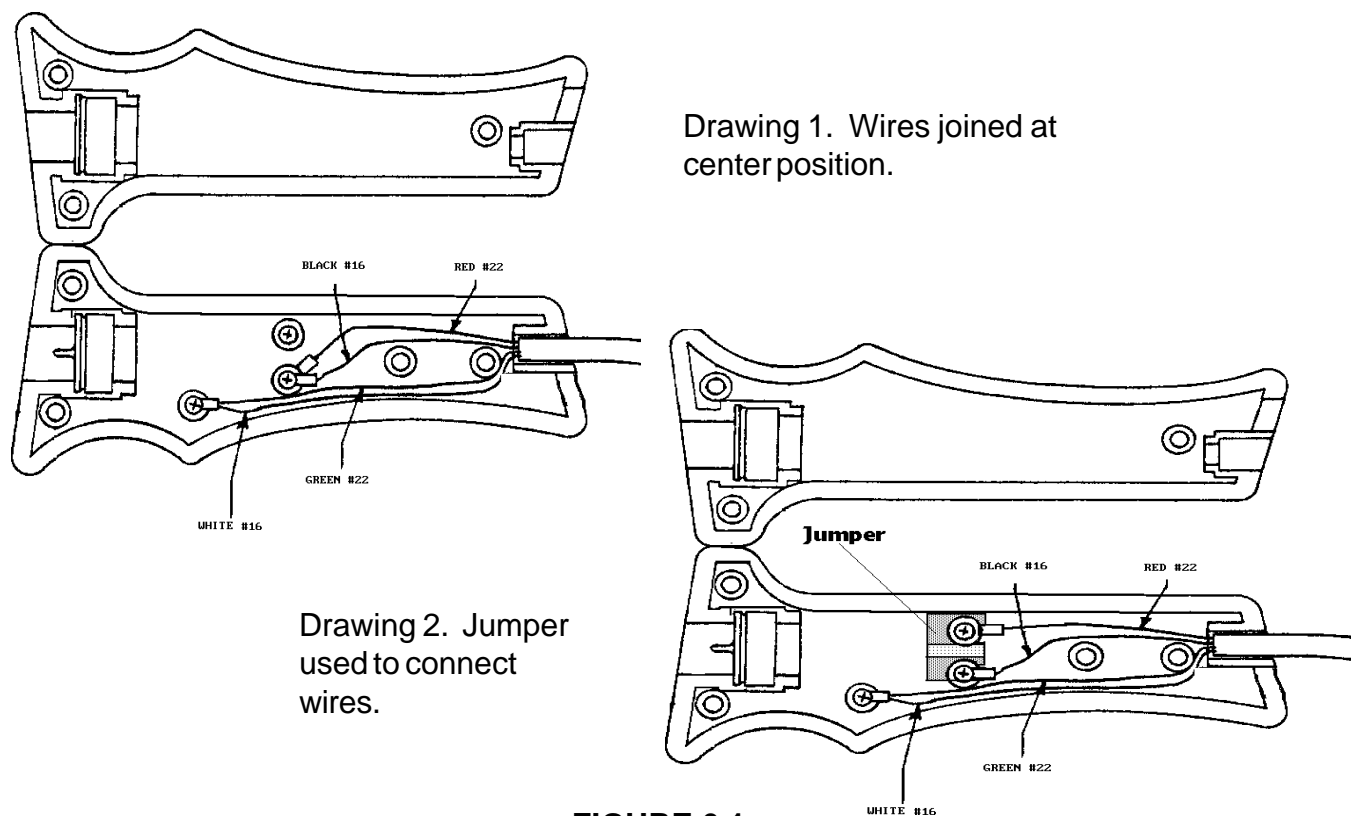
**FIGURE 6.1**

## PYROPROBE LEAD CONNECTIONS FOR GC OR FT-IR PROBES

### Warning

THE PYROPROBE MUST BE UNPLUGGED BEFORE ATTEMPTING TO MAKE ANY ELECTRICAL CONNECTIONS SUCH AS REPLACING THE PROBE FILAMENT.

### Caution

PROBE FILAMENTS ARE MADE OF PLATINUM WHICH IS EASILY DAMAGED. DO NOT TOUCH THE FILAMENT WHILE REPLACING THE PROBE ROD.

The standard GC or FT-IR probe terminates in a return strap, which is connected to the combined green and white wires in the Pyroprobe handle, and two wires. The smaller wire on the probe is connected to the red wire at the top connector in the Pyroprobe handle, and the larger wire is connected to the black wire at the center connector. When changing from a direct insertion probe to a standard probe, the red wire in the handle must be moved to the top connector as shown in the drawing below.

When changing from a standard GC or FT-IR probe to a direct insertion probe for mass spectrometry work, the red wire must be combined with the black wire as shown on page 6.2. In addition, the ballast resistor must be changed according to the instructions found on page 6.5.

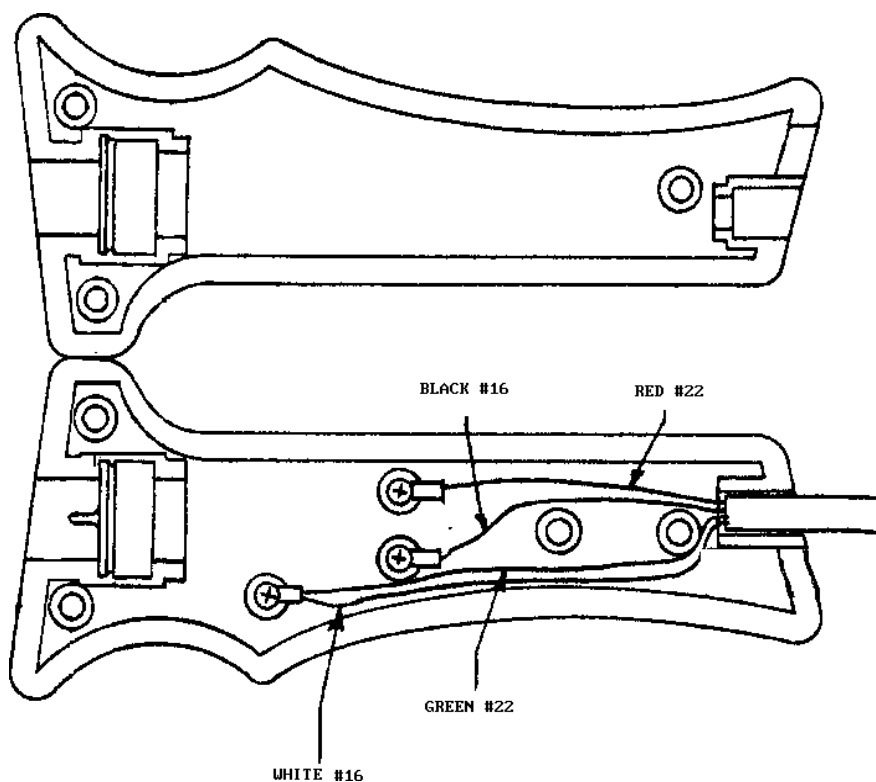

**FIGURE 6.2.**

**PYROPROBE 5000 LEAD CONNECTIONS FOR THERMOCOUPLE PROBE****Warning**

THE PYROPROBE MUST BE UNPLUGGED BEFORE ATTEMPTING TO MAKE ANY ELECTRICAL CONNECTIONS SUCH AS REPLACING THE PROBE FILAMENT.

**Caution**

PROBE FILAMENTS ARE MADE OF PLATINUM WHICH IS EASILY DAMAGED. DO NOT TOUCH THE FILAMENT WHILE REPLACING THE PROBE ROD.

The Thermocouple probe for the Pyroprobe terminates in one connector which is attached to both the red and black wires in the handle, and a return strap which is connected to the combined green and white wires. When changing from a standard (GC or FT-IR) probe to a thermocouple probe, the red and black wires must be connected together at the upper fitting in the handle before attaching the probe, as shown in the drawing below, making sure that none of the connectors touch the stainless steel feed-through tubing or the 1/16" union used to secure the thermocouple.

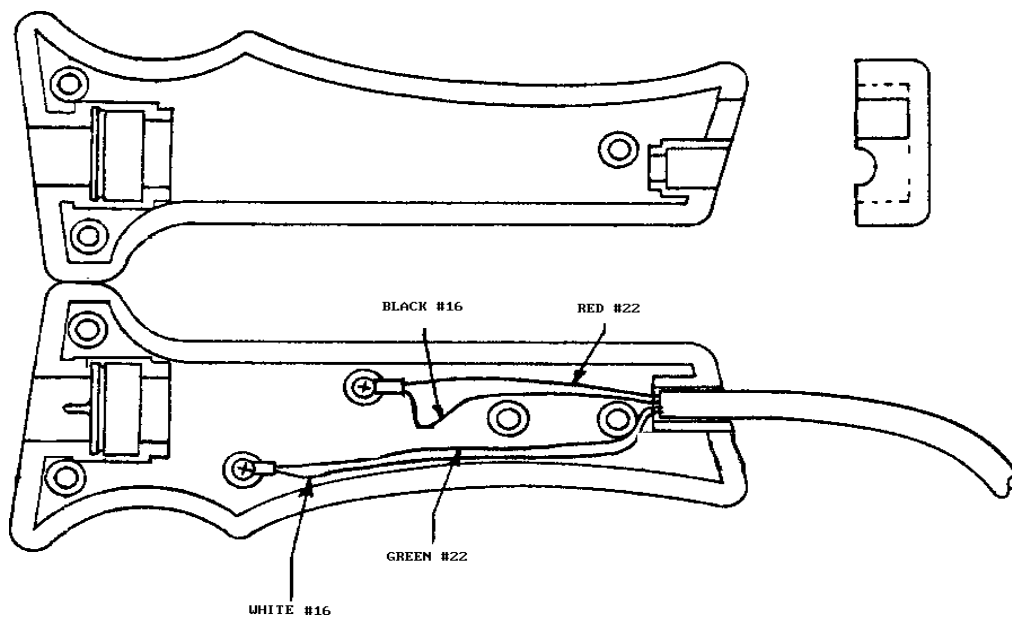
**FIGURE 6.3.**

### **IMPORTANT NOTE CHANGING BALLAST RESISTOR**

**Internal ballast resistor must be changed before using 16-inch DIP probe or severe probe damage could occur.**

To change the ballast resistor:

- 1) Unplug Pyroprobe.
- 2) Remove left hand side Pyroprobe cover.
- 3) Locate terminal strip on the board, see Figure 6.4.
- 4) Loosen screws just enough to remove ballast resistor which is connected to terminals B and E of the terminal strip.
- 5) Replace with the other ballast resistor provided.

**CAUTION:** The longer ballast resistor can only be inserted in one direction (see drawing).

**ALSO:** The ballast resistor should not be touching any wires, the chassis, or the probe storage tube after it is in place.

*16-inch DIP probe -- short ballast resistor*

*8-inch standard probe -- long ballast resistor*

- 6) Replace the cover on Pyroprobe.
- 7) Plug unit in and resume normal operation.



Ballast Resistor

FIGURE 6.4.

## PROTECTED COIL PROBE

A ruggedized version of the coil Pyroprobe is available as the 1/2 inch protected coil probe. In this probe, the platinum coil is wrapped around the outside of a permanent quartz tube. Samples are placed into a smaller quartz sample tube, which then slides into the tube which is a part of the probe. This prevents the sample tube from disrupting the platinum coil when samples are placed into the probe for pyrolysis.

The protected coil probe requires a 1/2 inch Interface for connecting to the gas chromatograph.

Because the sample is held inside of a tube within a tube, the heating rate of the sample is dampened, and it is advisable to increase the pyrolysis time to compensate for the double thickness of quartz. The maximum setpoint for the protected coil probe is 1300°C.

The "permanent" or larger of the quartz tubes, which protects the platinum coil, is held into the probe by a threaded cap. This tube may be changed for cleaning, or if it becomes damaged. To remove the protective quartz tube, unscrew the retaining cap which holds it in place, as shown in Figure 6.5.

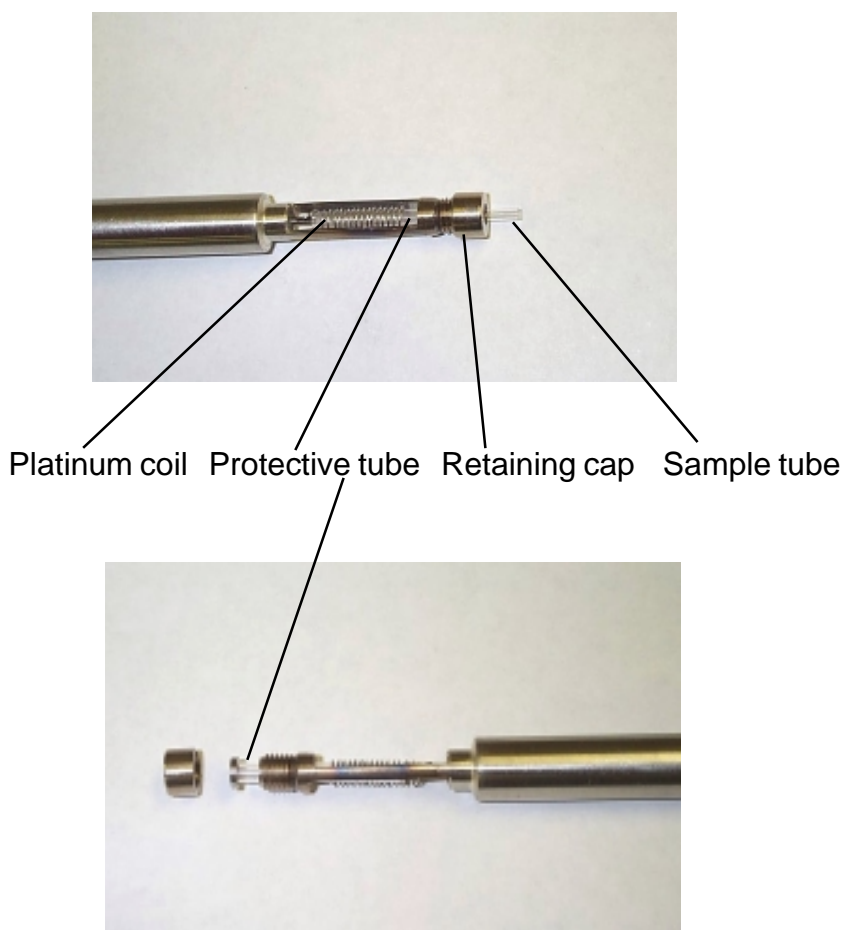

**FIGURE 6.5.**

The Protected Coil Pyroprobe is connected to the black Pyroprobe handle in the same way that the standard GC and FT-IR Pyroprobe filament rods are connected, as shown in Figure 6.6.

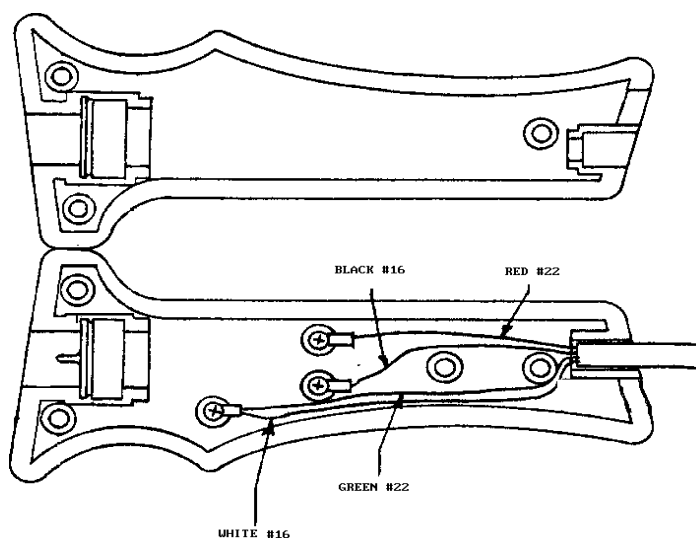

**FIGURE 6.6**

## **SECTION 7. FT-IR INTERFACING, THE BRILL CELL**

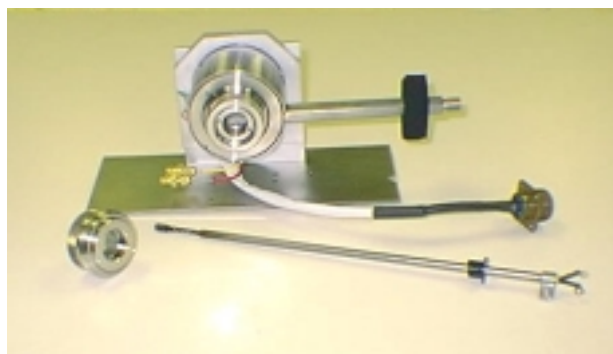

### **INTRODUCTION**

Use of the CDS Analytical Brill Cell and the Pyroprobe 5000 permits the analysis of solid materials by the combined technique of Pyrolysis-FT-IR. The Brill Cell is designed to fit into the sample compartment of a standard FT-IR bench, and thus places the filament of the Pyroprobe directly in the light path, for immediate acquisition of spectral data. Samples may be placed directly onto the surface of the ribbon probe, or held in a quartz boat for use of the coil probe. With the filament positioned just below the light path, the sample may be heated rapidly for a single spectrum analysis of the material, or slowly with multiple scans recorded for time/temperature studies.

The Brill Cell is mounted into the sample compartment of the FT-IR by attaching a base plate, as with other FT-IR accessories. To permit easy insertion of samples, a replacement cover is required, with an access hole for the probe rod of the Pyroprobe. This allows the sample to be placed into the Brill Cell without disturbing the optics purge of the bench. An additional purge and flow controller is supplied for the cell itself, including an on/off valve. This flow may be used to purge the cell between runs, to purge the cell continuously during a long, programmed run, or to supply an atmosphere inside the Brill Cell different from the nitrogen used to purge the bench optics.

Pyrolysis FT-IR may be used to support and confirm data obtained by Pyrolysis-GC or Pyrolysis-MS, to screen samples rapidly for identification, for quality control of polymeric materials, to provide FT-IR information on opaque, filled or complex materials, or to study thermal processes with the immediacy of in-beam sampling. The Pyroprobe 5000 may be used for gas chromatography, mass spectrometry or FT-IR simply by changing the probe rod and using the appropriate interface.

### **DESCRIPTION**

The CDS Analytical Brill Cell is a sampling attachment using standard windows (25 mm diameter, 4 mm thick) which permits the positioning of the Pyroprobe filament into the sample compartment for direct Pyrolysis-FT-IR. It includes fittings for inlet and outlet of a purge gas, a mounting plate, a vertical support tower, seals, gaskets, two sets of windows, and a pneumatics module which incorporates the cell purge gas flow controller, on/off valve and fittings. The Brill Cell includes a heater for the cell body, which is controlled by the accessory heater control of the Pyroprobe.

The windows are held in an easily removable retainer which is threaded to permit cleaning and replacement of the windows without disturbing the cell body. The Brill Cell comes supplied with one set of KBr windows and one set of ZnSe windows, and all the necessary gaskets to seal the windows into the cell body.

Brill Cells are configured and supplied for installation into specific FT-IR benches from major manufacturers. Because the sample compartment dimensions, beam height above the sample compartment floor, focal point and cabinetry differ from one manufacturer to another, the specific mounting plate, positioning of inlets, cover, etc. will change from one instrument to another. The installation instructions included here are general, and use diagrams which are typical, but may differ from the actual unit being installed. Figure 7.1 shows a side view and an end view of a typical Brill Cell, indicating the positioning of the various parts. The window retainers screw into the cell body, which is held in place by the vertical tower, which is mounted into the base plate. The base plate has several grooves cut into it to receive the vertical tower. This is to permit correct positioning of the cell with regard to the beam height and focal point configuration of the FT-IR bench concerned. In all cases, the Brill Cell must be positioned so that the FT-IR beam passes directly through the cell and over the filament of the Pyroprobe. Holes in the base plate are provided which align with threaded holes in the floor of the FT-IR sample compartment to anchor the entire sampling module.

A replacement cover for the FT-IR is available to provide easy access for the probe rod, and mounting for the additional pneumatics. Figure 7.2 shows the pneumatic module for the Brill Cell, including the purge gas fittings, flow controller and on/off valve.

## **INSTALLATION**

Complete installation of the Brill Cell for pyrolysis FT-IR involves the correct positioning of three main parts: the Brill Cell proper, the replacement cover for the FT-IR bench, and the pneumatics module for the cell purge gas. The cell may be used without replacing the cover and installing the pneumatics, but this would require leaving the original cover of the FT-IR open for probe access, interrupting the optics purge. Alternatively, the original instrument cover may be modified with a probe insertion port by the user, or delivered to CDS for modification. In the following instructions, specific parts will be mentioned as they are shown in Figure 7.1. The number in parentheses after the part name is the item number as it is used in the diagram.

### **THE CELL BODY**

When the Brill Cell is ready to be placed into the sample compartment of the FT-IR, it resembles the one shown in Figure 7.3. The cell body is held in the vertical tower (7), which fits into the cell base (8). The cell base is attached to the bottom of the FT-IR sample compartment using screws through holes in the base which align with mounting holes in the FT-IR. For this reason, it is necessary to specify the make and model of the FT-IR used when purchasing the Brill Cell, and may be necessary to purchase additional cell bases to interface to other FT-IR benches. The cell body is held in the vertical tower (7) by tightening a screw (14) at the top of the tower.

## **WINDOWS**

The cell windows (5) are held in a large threaded nut (3) which screws into the cell body. The window should have an o-ring (4) on either side of it, and is held into the nut with a window retainer (6). The assembled nut (3) is screwed into the cell body, using a larger o-ring (2) to seal it into place. To replace windows, a window retainer tool (15) is provided.

## **INSTRUMENT COVER**

To permit access for the Pyroprobe and mounting for the cell purge pneumatics, a replacement cover for the FT-IR bench is available for use with the CDS Brill Cell. In general, the original cover for the bench is hinged at the top, back, and is designed to cover both the top and front of the sample compartment. The typical replacement cover hinges at the same location and is constructed to cover the top and front, and has an access hole for the probe. The modified instrument cover must also include two Swagelok bulkheads for cell flow in and out, and the electrical fitting to connect the Brill Cell heater to the Pyroprobe controller. The original cover should be removed at the hinge, and the new cover attached in the same way.

In some instruments, the original cover will have replaceable panels, and the access hole and pneumatics have been configured on new panels intended to replace these. These may be held in place either with retainers or magnets, and the new panels attach in the same way used for the original panels. In all cases, the probe inlet tube (11) should project through a hole in the cover or panel, using the cover gasket to prevent air intrusion.

## **PNEUMATICS MODULE**

The Brill Cell is purged using a flow controller which is provided in a pneumatics module, together with fittings for connecting the purge gas, and an on/off valve. Flow is attached from the inlet bulkhead to the flow controller then to the on/off valve. From here it proceeds to the inlet fitting of the cell body, purges the cell and exits the top fitting which is connected to the cell vent bulkhead on the panel. The diverter valve has three positions: ON, in which the purge gas, controlled by the flow controller proceeds to the Brill Cell; OFF, in which there is no purge flow; and PURGE, in which a high volume of purge flow bypasses the flow controller and goes to the cell to purge it rapidly after use.

## **PYROLYSIS USING THE BRILL CELL**

Once the Brill Cell has been installed in the sample compartment of the FT-IR, the cover replaced and the optics purged, samples may be pyrolyzed using either the ribbon or coil filament of the Pyroprobe. Samples should be placed directly onto the surface of the ribbon probe, in the center of the platinum filament. When heated, the ribbon expands, and should deflect down, away from the FT-IR beam. This can be verified by examining the position of the filament using the "clean" function of the Pyroprobe. When using the coil probe, the sample should be held in a quartz boat which permits the sample volatiles to go directly into the light path.

It is generally necessary to use a larger sample for analysis by Pyrolysis-FT-IR than is used for Pyrolysis-GC. For gas chromatography, 10-100 micrograms is generally sufficient while for FT-IR work, 100-200 microgram samples are typical. This, of course, depends on the organic content of the sample and the kind and sensitivity of detector used. The cell purge gas may be left on during analysis, or used to flush the cell between runs. Since the purge gas for the cell is isolated from the rest of the FT-IR instrument, a gas other than nitrogen may be used, including air or oxygen for oxidation studies.

The cell heater for the Brill Cell is intended to reduce condensation of pyrolysate, especially on the windows. It should be operated at a temperature sufficient to keep the pyrolysis volatiles in the vapor phase so that they may be flushed from the cell. The heated cell may be used at ambient temperatures with standard o-rings, or at elevated temperatures, using high temperature o-rings (2,4) to seal the windows (5) and window nuts (3).

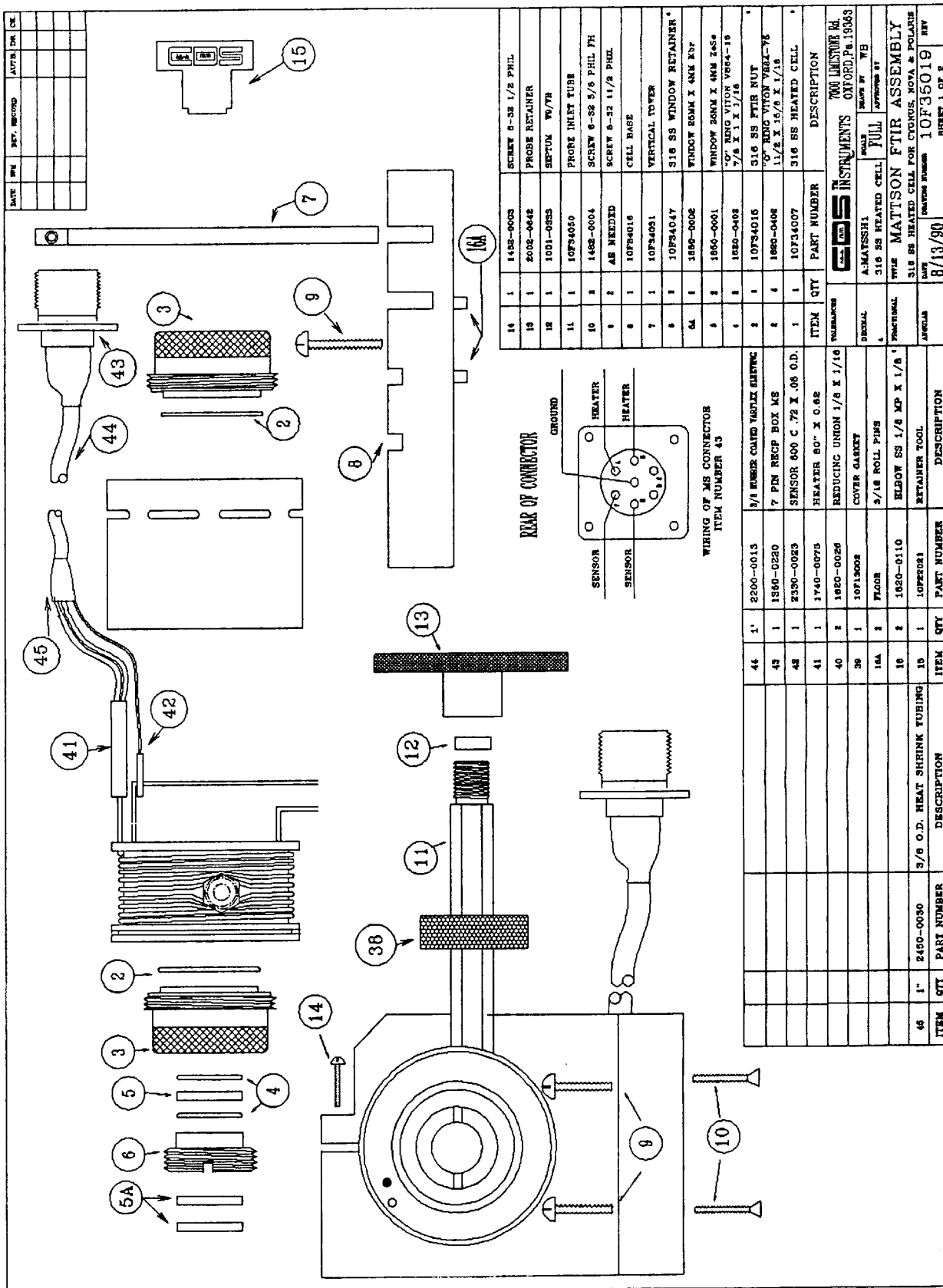

FIGURE 7.1. BRILL CELL

Purge flow module, front view



Diverter valve

Flow controller

Purge flow module, rear



Bulkheads for flow in from tank and flow out to Brill Cell

FIGURE 7.2. PNEUMATICS MODULE FOR BRILL CELL

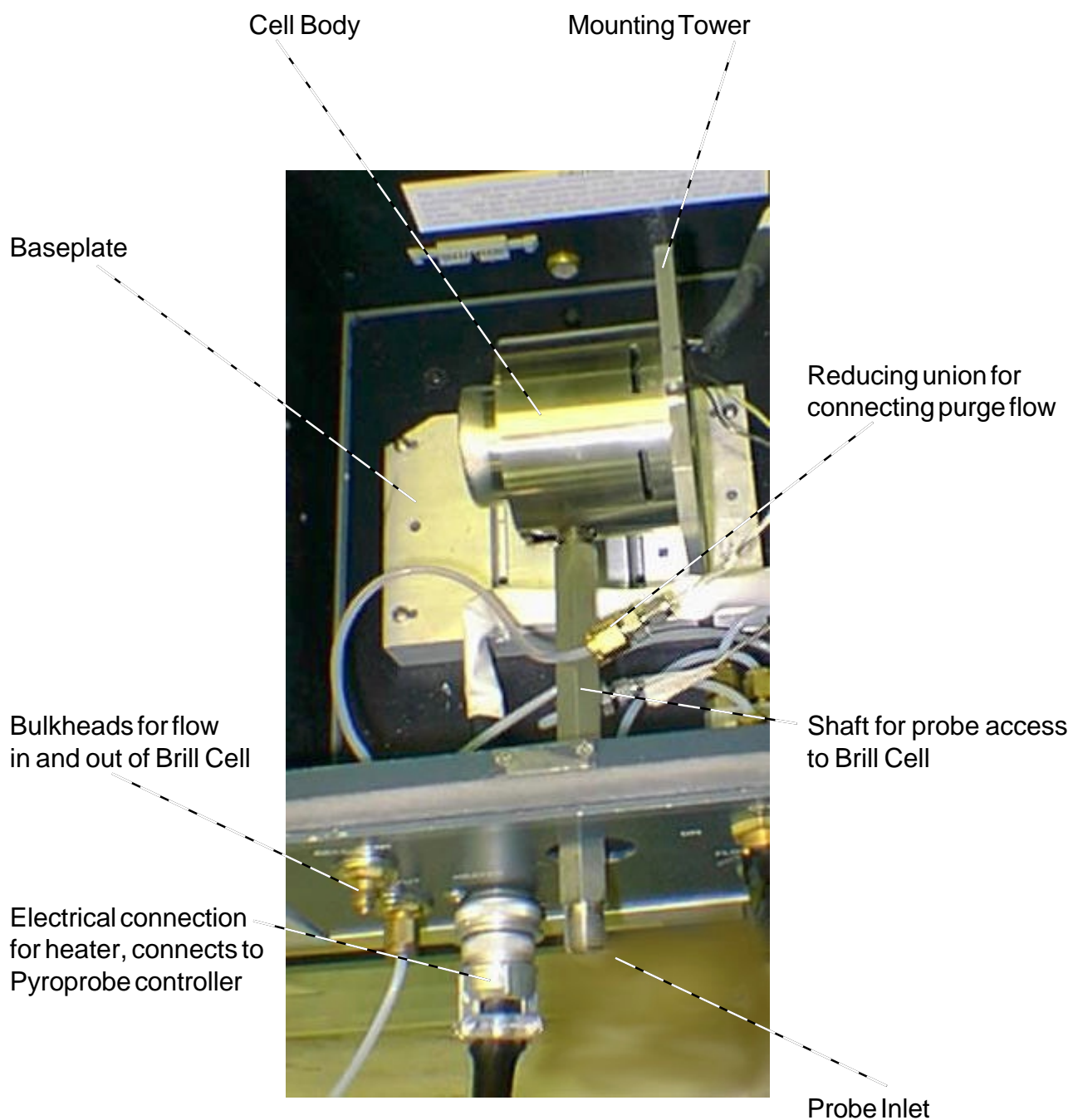

FIGURE 7.3. BRILL CELL AS SEEN FROM TOP IN INSTRUMENT.

### **UNIVERSAL MOUNTING FOR BRILL CELL**

When the Brill Cell is supplied for a specific make and model of FT-IR, the mounting plate is configured to match accessory installation holes for correct positioning of the cell within the sample compartment. Alternatively, the cell may be provided with a “universal” mounting arrangement which permits installation into a variety of FT-IR makes, permitting use in multiple instruments. Instead of a solid mounting plate with pre-drilled holes, the bottom of the cell is equipped with movable brackets. These brackets should be positioned inside the sample compartment so that they are aligned with the mounting holes in the bottom and the cell is held in the correct position relative to the center of focus.

To adjust the height of the Brill Cell to match the beam height of the FT-IR, the “tower” is also slotted, permitting the cell to slide up and down. When the proper height has been reached, the cell should be held in place using the screws which extend through the slots and into the body of the cell.

## **ELEVATED PRESSURE OPTION FOR THE BRILL CELL**

The Brill Cell may be equipped with pressure control, which connects to the outlet of the cell, for operation at elevated pressures. The Pressure Control Option is supplied in a pneumatics module which includes a back pressure control knob, a diverter valve and a pressure gauge. This back pressure module is used in conjunction with the Brill Cell pneumatics which supply carrier flow into the cell.

### **INSTALLATION**

When connecting the Brill Cell Elevated Pressure Option module, be sure that the standard Brill Cell purge pneumatics are already installed according to instructions in this manual. The standard purge pneumatics provide a flow controller (metering valve for elevated pressure operation) to deliver carrier gas to the cell, a diverter valve to direct the purge gas and a cell vent fitting. The Elevated Pressure pneumatics module is connected to the outlet of the Brill Cell at the vent fitting. On the rear of the Elevated Pressure module are two fittings, marked "From Brill Cell" and "Vent". Pressure inside the Brill Cell is controlled by connecting the outlet vent from the Brill Cell pneumatics to the fitting marked "From Brill Cell" on the back of the Elevated Pressure module. The vent for the entire cell system is now the fitting marked "Vent" on the back of the Elevated Pressure module. A pneumatics diagram for the connection of the Elevated Pressure option to the Brill Cell outlet is shown in Figure 7.4.

**Caution**

OPERATION OF THE BRILL CELL AT ELEVATED PRESSURES REQUIRES CARE TO REDUCE PRESSURE BEFORE REMOVING PROBE, AND TO INSURE THAT THE ZnSe WINDOWS ARE SERVICEABLE, AS DESCRIBED ON THE NEXT PAGES.

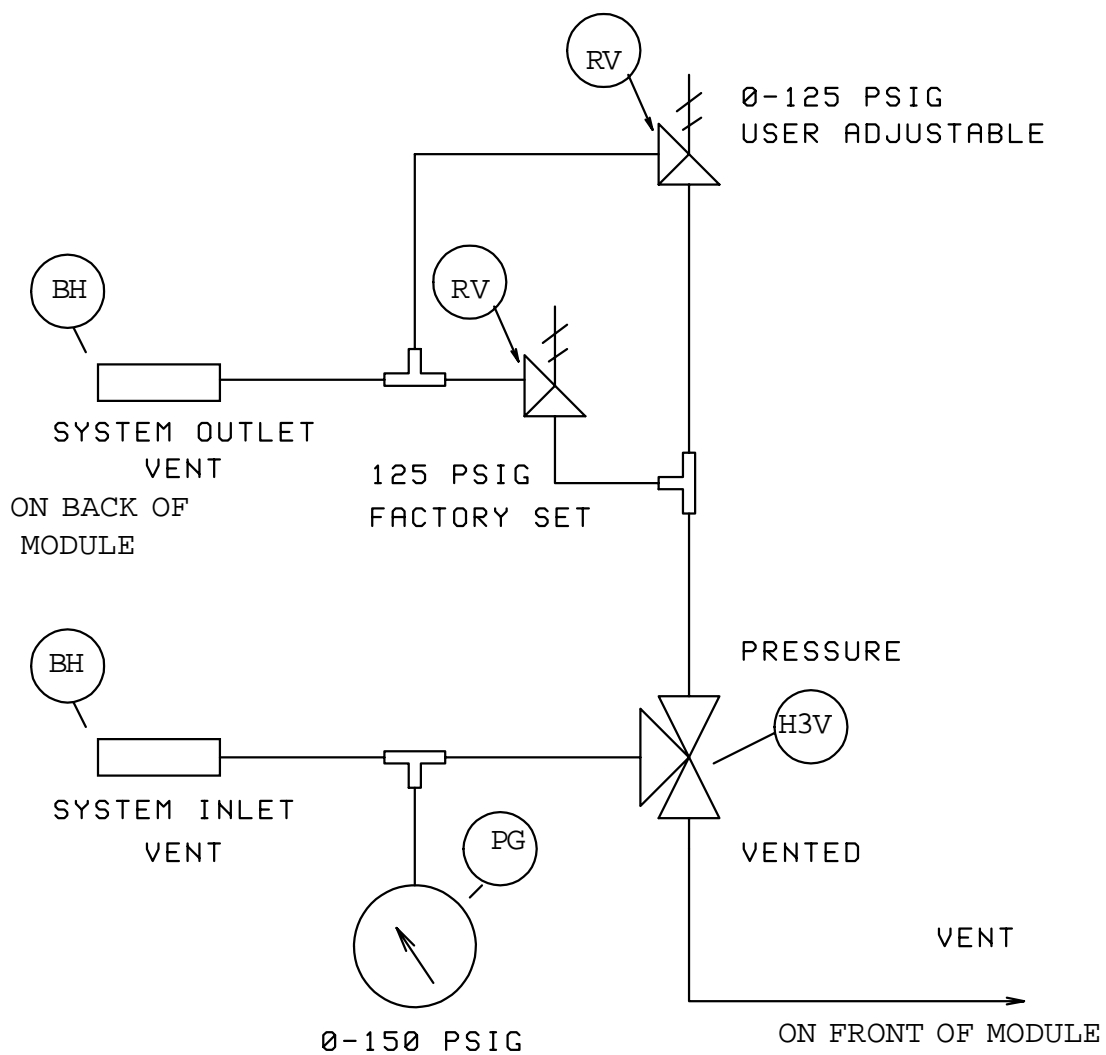

FIGURE 7.4 ELEVATED PRESSURE OPTION PNEUMATICS DIAGRAM.

## OPERATION

The front panel of the Elevated Pressure Option module includes a pressure gauge, a diverter valve and a vent, arranged as shown in the diagram below.

Once the Elevated Pressure Option module has been connected to the outlet of the Brill Cell, pressure inside the cell may be regulated by adjusting the back pressure control knob, which is located on the **back** of the pressure module. System pressure is displayed on the pressure gauge located on the front panel of the Elevated Pressure module. When the diverter valve is turned to the "PRESSURE" position, purge gas from the cell is directed to the back pressure controller before being vented from the system outlet vent located on the rear of the Elevated Pressure module. If the diverter valve is in the "VENT" position, flow from the cell goes immediately out the vent on the **FRONT** panel of the Elevated Pressure module. (Refer to the diagram in Figure 7.4, in which the diverter valve is marked H3V, Vent is immediately adjacent to it, and SYSTEM OUTLET VENT is on the rear of the module, after the back pressure controller.)

To set a pressure in the Brill Cell, be sure that the metering valve and diverter valve upstream of the cell in the purge gas control module are ON, and that the probe is secured into the Brill Cell, then put the diverter valve of the Elevated Pressure module to the PRESSURE direction. Now select the desired pressure on the pressure gauge by turning the back pressure control knob on the rear of the pressure control module.

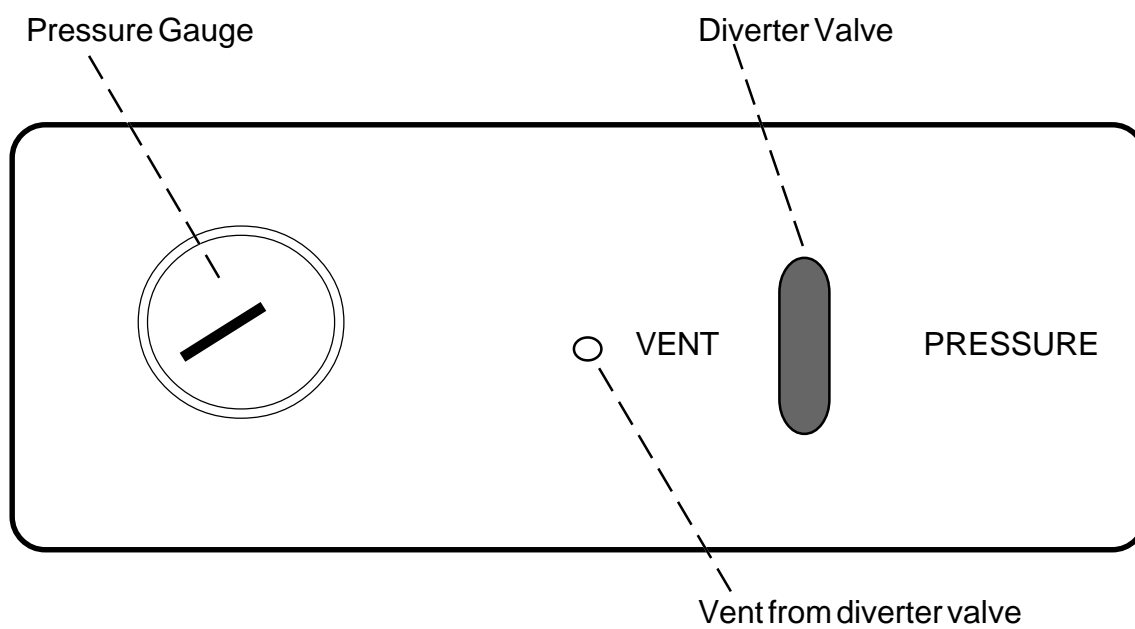

**ELEVATED PRESSURE MODULE FRONT PANEL**

To control the probe rod when removing it from the cell after an analysis, *always be sure to depressurize the cell before loosening the probe connection to the Brill Cell*. To depressurize, turn the diverter valve on the elevated Pressure module to the VENT position, reduce the pressure setting, or both.

## SAFETY

The Elevated Pressure module includes a factory set pressure relief device which limits the system pressure to 500 PSIG. If system pressure exceeds this limit, the relief valve will open and vent the system through the SYSTEM OUTLET VENT on the back of the Elevated Pressure module.

When operating the Brill Cell at elevated pressures, be sure that the ZnSe windows used in the cell are not scratched, cracked or otherwise incapable of withstanding the pressure used. **Use of KBr windows, or imperfect ZnSe windows could permit fracturing of the window**, throwing fragments into the optics of the FT-IR. Also be sure that the Pyroprobe rod is secured firmly into the Brill Cell before increasing system pressure. To protect the windows from sudden pressurization, increase the back pressure in the Brill Cell gradually to the operating level. Exercise caution when turning the diverter valve of the Elevated Pressure module to the VENT position when the system is at elevated pressure, since this causes the pressurized cell gas to vent rapidly from the front of the module.

## CHANGING THE OPERATING PRESSURE RANGE

The Elevated Pressure module for the Brill Cell comes with two interchangeable pressure control springs to change the operating range. The BLUE spring covers pressures ranging from 50 to 350 PSIG, and the YELLOW from 350 to 750 PSIG (although the system is preset at the factory not to exceed 500 PSIG). To change the spring, turn the pressure setting knob all the way counterclockwise until the knob unscrews from the unit. The spring may now be removed, and replaced with the other one to change the operating range. Insert the new spring and screw the knob back onto the unit.

## **SECTION 8. SAMPLE HANDLING KIT**

### Contents:

- One pair of sample tweezers
- One blade and handle
- Plunger for inserting samples and quartz wool
- Quartz wool and tubes
- Reference polymers;
  - Kraton 1107 (Styrene/isoprene copolymer)
  - Nylon 6.6
  - Polyethylene (Low density)

The CDS Analytical Sample Handling Kit provides small tools to help prepare samples for pyrolysis using the Pyroprobe. For suggestions concerning sample size, temperatures and other parameters, please refer to the guide "Getting Started Is Easy" which may be found in the binder pocket of this manual.

To help evaluate the functioning and interfacing of the Pyroprobe, analyses of the three reference materials included in the kit are provided on the following pages, both by GC-MS and FT-IR.

CDS Analytical offers many one-page application notes demonstrating the analysis of materials using pyrolysis. These may be obtained directly from CDS by contacting the office at 800 541 6593, or they may be downloaded from our web page, **[www.cdsanalytical.com](http://www.cdsanalytical.com)**.

Sample: Polyethylene  
Pyrolysis: 750°C for 15 seconds  
GC: HP 6890  
Column: HP-5, 30 m x 0.25 mm  
Initial: 40°C for 2 minutes  
Ramp: 6°C/minute  
Final: 295°C  
Detector: MSD  
Carrier: Helium, split 75:1

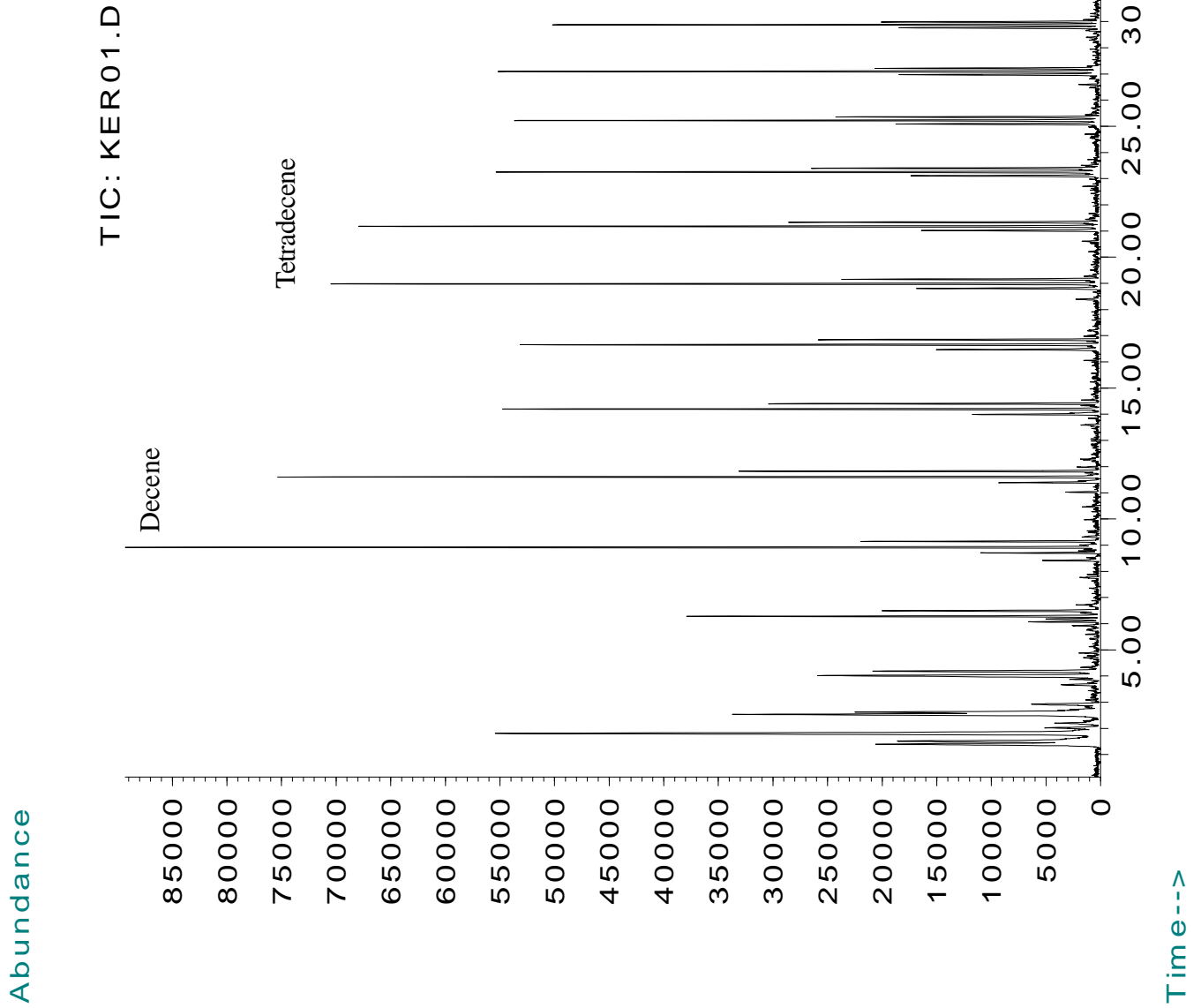

Time-->

Abundance

TIC: PYMS20.D

Sample: Kraton 1107  
Pyrolysis: 750°C for 15 seconds  
GC: HP 6890  
Column: HP-5, 30 m x 0.25 mm  
Initial: 40°C for 2 minutes  
Ramp: 10°C/minute  
Final: 295°C  
Detector: MSD  
Carrier: Helium, split 75:1

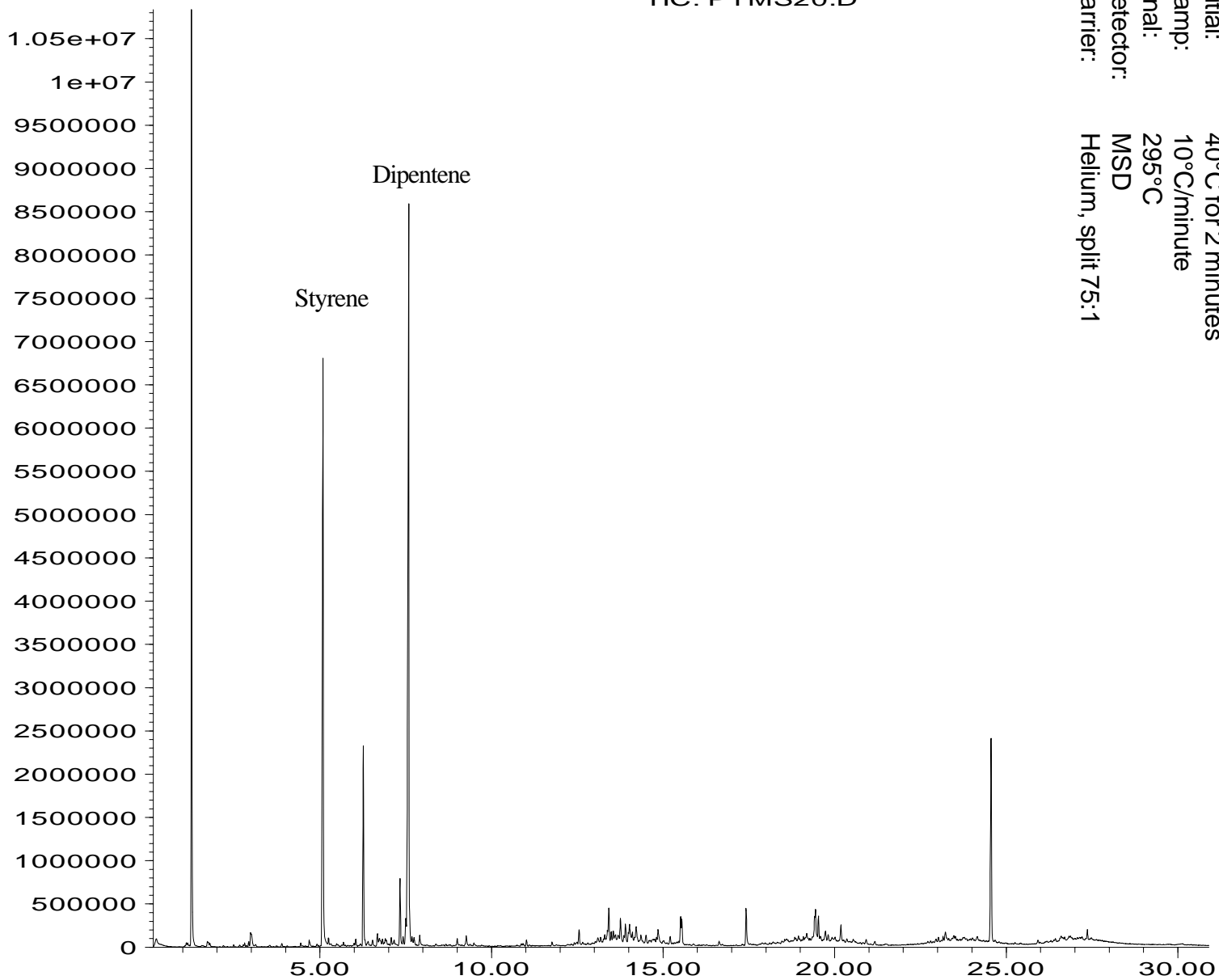

Time-->

Sample: Nylon 6/6  
Pyrolysis: 750°C for 15 seconds  
GC: HP 6890  
Column: HP-5, 30 m x 0.25 mm  
Initial: 40°C for 2 minutes  
Ramp: 10°C/minute  
Final: 295°C  
Detector: MSD  
Carrier: Helium, split 75:1

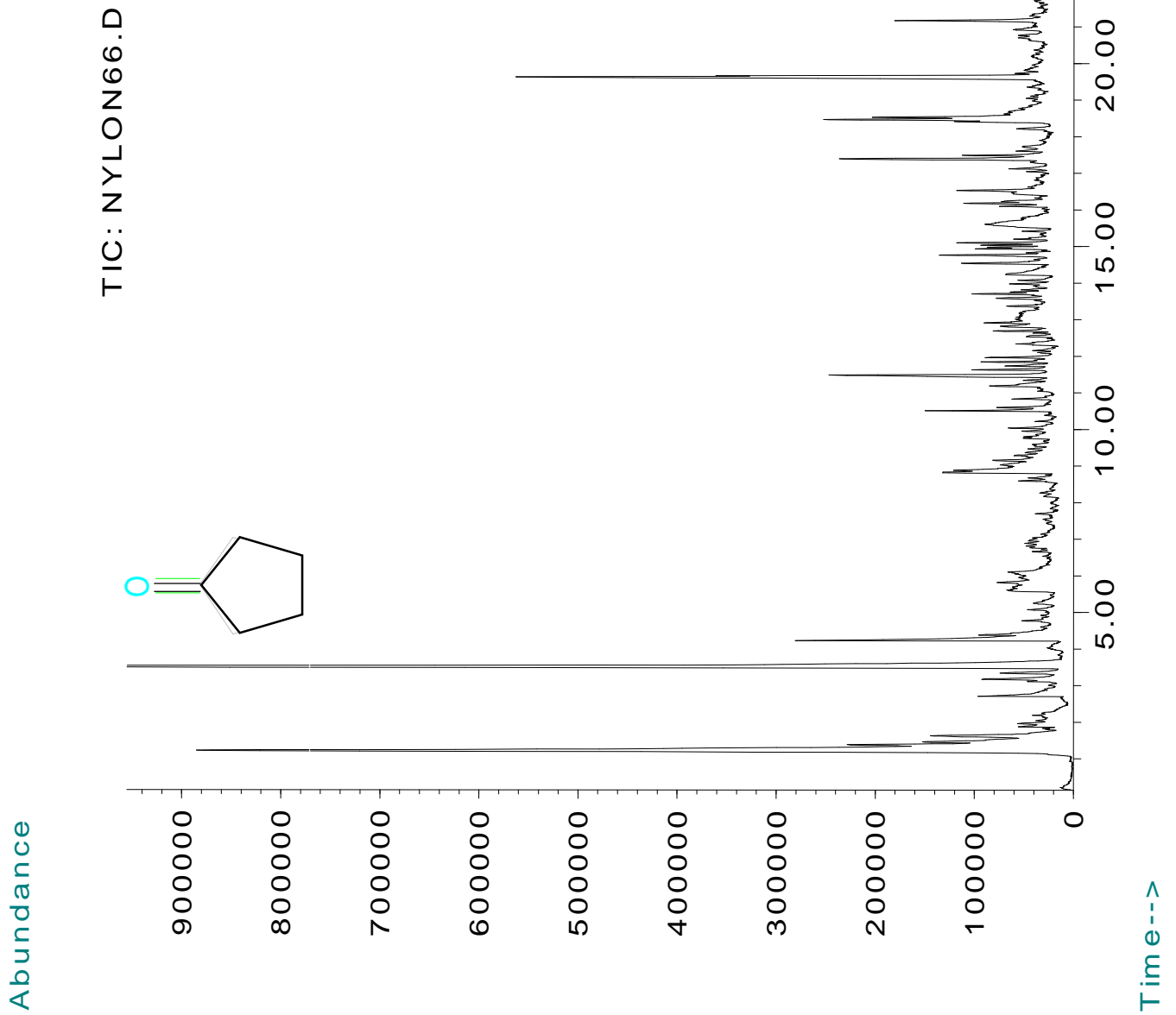

SAMPLE: POLYETHYLENE

PYROLYSIS

Temperature: 850 C  
Rate: 0.1 Degree/ms  
Cell Flow: 10 ml/min

SPECTROSCOPY

Nicolet 710  
Detector: DTGS  
Scans: 32

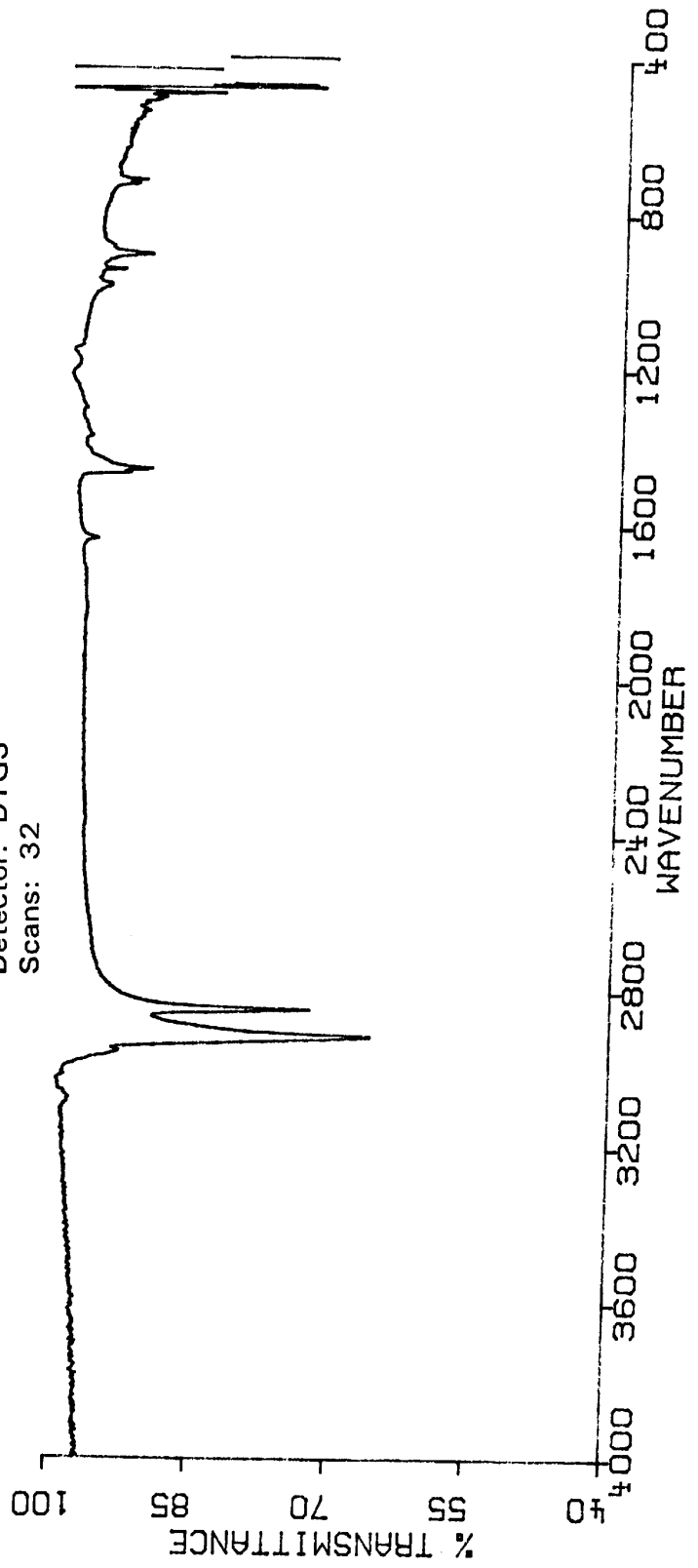

SAMPLE: KRATON 1107

PYROLYSIS

Temperature: 850 C  
Rate: 0.1 Degree/ms  
Cell Flow: 10 ml/min

SPECTROSCOPY

Nicolet 710  
Detector: DTGS  
Scans: 32

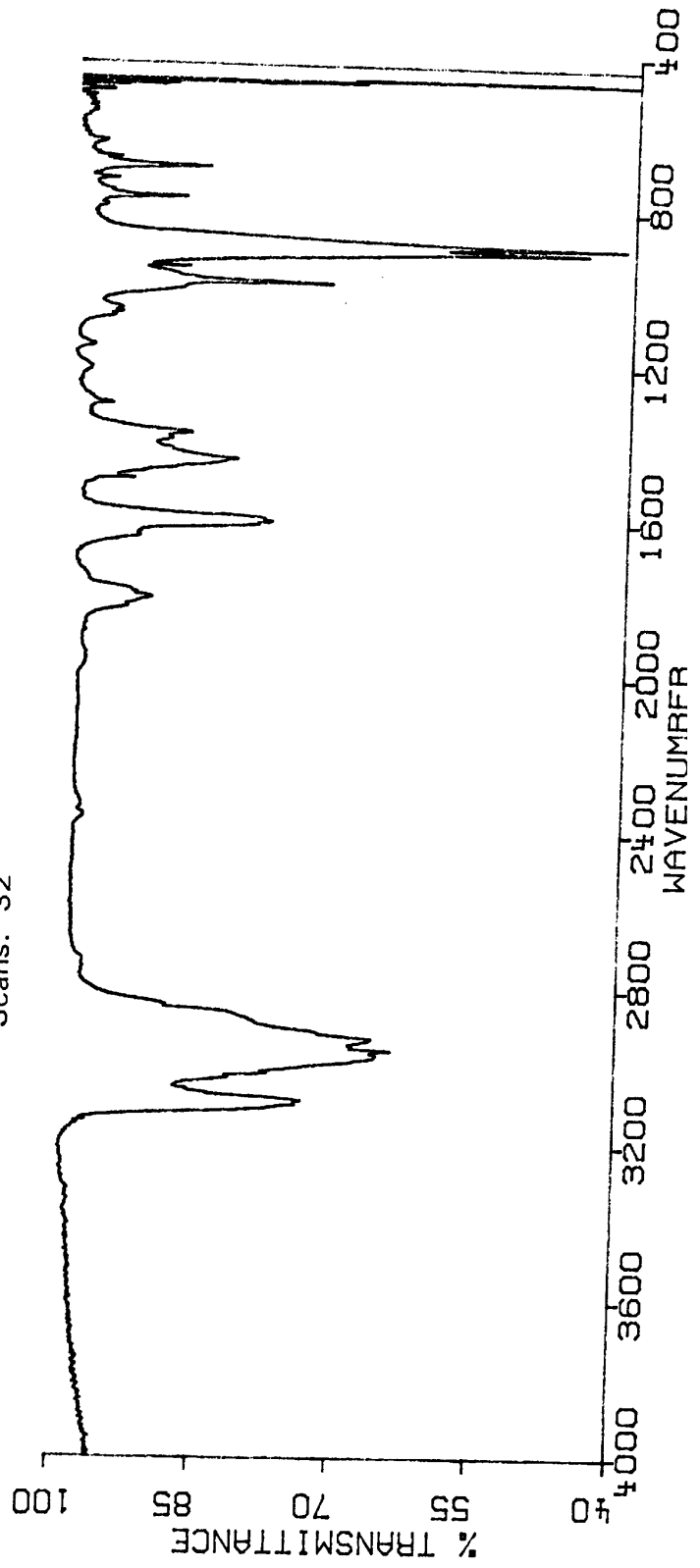

SAMPLE: NYLON 6/6

PYROLYSIS

Temperature: 850 C  
Rate: 0.1 Degree/ms  
Cell Flow: 10 ml/min

SPECTROSCOPY

Nicolet 710  
Detector: DTGS  
Scans: 32

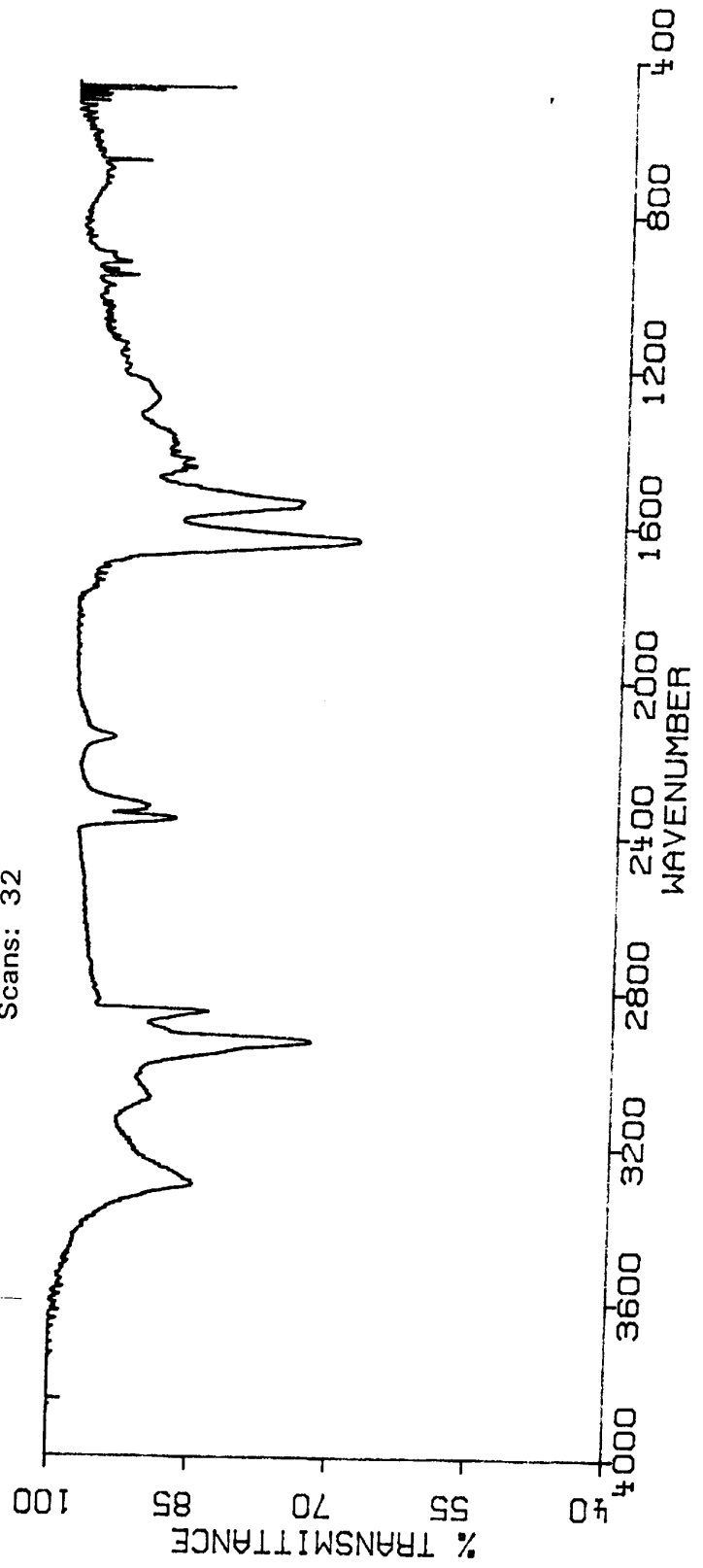

**SECTION 9. INDEX**

<b>DESCRIPTION</b>	<b>PAGE</b>
1500 interface	4.8
<b>A</b>	
1500 installation	5.3
1500 interface	5.1
1500 operation	5.9
5150 interfacing	5.12
Accessory programming	4.8
Accessory type	4.5
Adapter, GC septum retainer	5.8
Agilent 6890	5.7
Alternative probes	6.1
Auto-detect COM port	4.6
<b>B</b>	
Ballast resistor	6.5
Brill Cell	7.1
Bulkhead, carrier for 1500	5.2
Bulkhead, carrier for 5150	5.13
Bulkhead, purge gas for 5150	5.13
Bulkhead, purge gas for 1500	5.2
<b>C</b>	
Calibration	3.4
Capacity, quartz tubes	3.5
Capacity, sample	3.5
Care of filaments	3.6
Clean	4.7
Coil, care of	3.6
COM Port	4.6
Communications menu	4.6
Configuration menu	4.5
Connections, electrical	5.14
Consumables	2.6
Creating a sequence	4.10
Cut and paste	4.3
<b>D</b>	
Description - 5000	3.1
Description - 5150	3.3
Description - 5200	3.3
Dimensions, quartz tubes	3.5
DIP MS probe	6.1
Direct Insertion Probe	6.1

Diverter valve	5.10
Dry	4.7
<b>E</b>	
Edit menu	4.3
Editor, method	4.12
Electrical connections	5.14
Elevated pressure, Brill Cell	7.9
<b>F</b>	
Filament, programming	4.7
Filament, ribbon	3.7
Filaments, care of	3.6
File menu	4.2
Front Panel	3.2
FT-IR cell	7.1
FT-IR cell installatioin	7.2
FT-IR Instrument cover	7.3
FT-IR mounting	7.8
FT-IR probe	6.3
Fuses	5.14
<b>G</b>	
GC handshaking	4.5
GC interfacing	5.1
GC septum retainer adapter	5.8
GC start	4.5
Glass inserts, 1500	5.11
<b>H</b>	
Handshake - GC	4.5
<b>I</b>	
Installation, 1500	5.3
Installation, Brill Cell	7.2
Installation, FT-IR cell	7.2
Interface programming	4.8
Interface, programmable	4.9
Interfacing, 5150	5.12
Interfacing, GC	5.1
Isothermal temperatures	4.11
Isothermal zones	4.11
Issue GC start	4.5
<b>J</b>	
<b>K</b>	
Keys	3.2
Kraton pyrogram	8.3

**L**

LEDs	3.2
------	-----

**M**

Menu - Communications	4.6
Menu - Configuration	4.5
Menu - Edit	4.3
Menu - File	4.2
Menu - Tools	4.4
Method editor	4.4, 4.12
Mounting bracket, FT-IR	7.8
Mounting tray	5.3

**N**

Needle assembly	5.8
Number, calibration	3.4
Nylon pyrogram	8.4

**O**

Open a sequence	4.10
Operation, 1500	5.9

**P**

PIDs	4.4
Pneumatics diagram, 1500	5.4
Pneumatics, FT-IR	7.3
Polyethylene, pyrogram	8.2
Pressure range, FT-IR	7.12
Pressure, Brill Cell	7.9
Probe cal #	3.4, 4.5
Probe calibration	3.4
Probe sample capacity	3.5
Probe, FT-IR	6.3
Probe, MS, connecting	6.2
Probe, protected coil	6.7
Probe, thermocouple	6.4
Probes, alternative	6.1
Programmable interface zone	4.9
Programming	4.1
Programming, accessory	4.8
Programming, filament	4.7
Programming, interface	4.8
Protected coil probe	6.7
Pyrogram, Kraton	8.3
Pyrogram, Nylon	8.4
Pyrogram, polyethylene	8.2
Pyrolysis-FT-IR	7.1

**Q**

Quartz boats	3.5
Quartz tubes	3.5

**R**

Resistor, ballast	6.5
Ribbon, care of	3.7
Ribbon, flexing	3.7
Run Method	4.7
Run Sequence	4.10

**S**

Sample capacity	3.5
Sample handling kit	8.1
Septum retainer, GC, adapting	5.8
Sequence	4.10
Specifications - 5151	2.2
Specifications - 5000	2.1
Specifications - 5200	2.3
Spectrum, Kraton	8.6
Spectrum, Nylon	8.7
Spectrum, polyethylene	8.5
Stabilizer, transfer line	5.14

**T**

Thermal PIDs	4.4
Tools menu	4.4
Transfer line	5.12
Transfer line stabilizer	5.14
Transfer line temperature	4.11
Transfer line, 5150	5.13

**U****V**

Valve oven temperature	4.11
Valve, 1500	5.1
Valve, 5150	5.12
Valve, diverter	5.10

**W**

Warranty	2.4
Windows, FT-IR	7.2

**X**

**Y**

**Z**

Zone, isothermal

4.11